

Traffic Management in Satellite Networks

Raj Jain

Professor of Computer and Information Sciences

Ohio State University

Columbus, OH 43210-1277

jain@cis.ohio-state.edu

These slides are available on-line at:

<http://www.cis.ohio-state.edu/~jain/talks/isart99.htm>



- ❑ Why Traffic Management?
- ❑ Why ATM?
- ❑ Improving TCP over ATM over Satellites
- ❑ Traffic Management in IP networks

Dime Sale

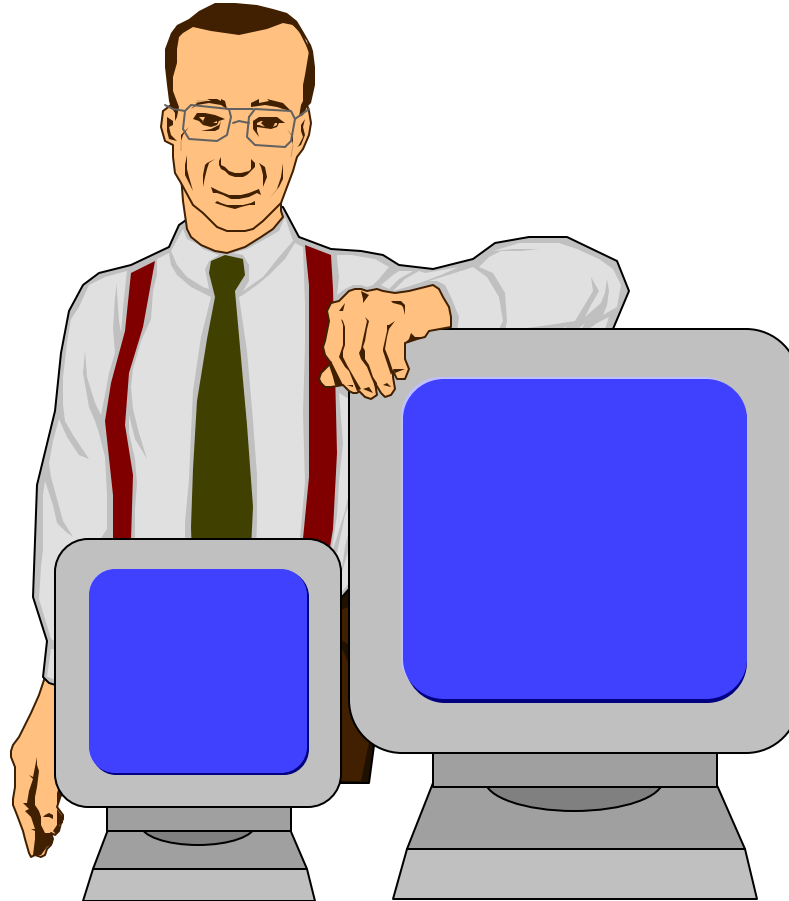

One Megabit memory, One Megabyte disk, One Mbps link, One MIP processor, 10 cents each.....

Future

Year

1980



In 1990, the memory will be so cheap that you will not have to worry about paging, swapping, virtual memory, memory hierarchy, and....

Why Worry About Traffic Management?

Q: Will the congestion problem be solved when:
Memory/Links/Processors become cheap ?

A: No. None of the above.

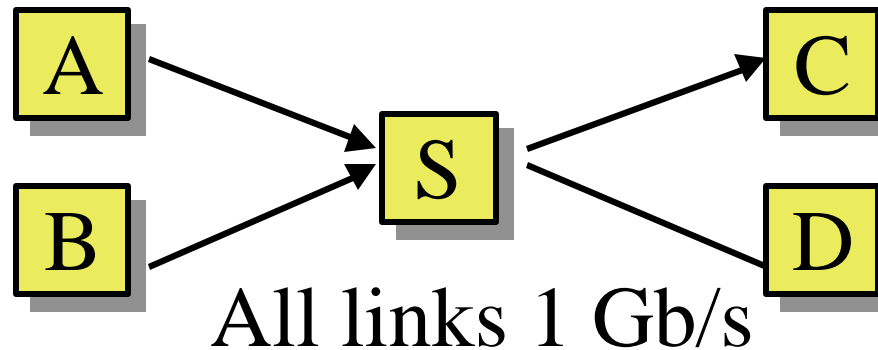

Conclusions:

- ❑ Congestion is a dynamic problem.
Static solutions are not sufficient
- ❑ Bandwidth explosion \Rightarrow More unbalanced networks

ATM

- ❑ ATM Net = Data Net + Phone Net
- ❑ Combination of Internet method of communication (packet switching) and phone companies' method (circuit switching)

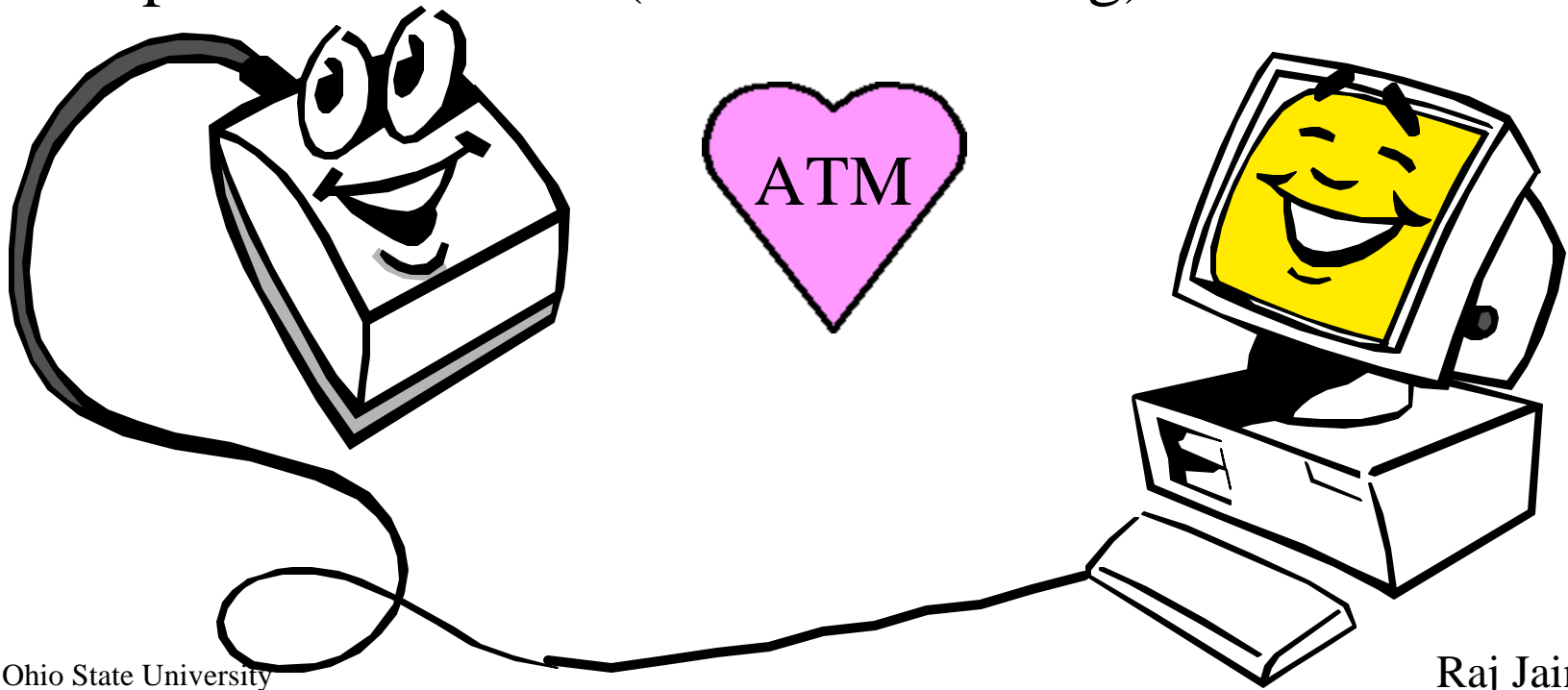

ATM vs Data Networks

- ❑ Traffic Management: Loss based in IP.
ATM has 1996 traffic management technology.
Required for high-speed and variable demands.
- ❑ Qos based Routing: Private Network to Node Interface (PNNI)
- ❑ Signaling: Internet Protocol (IP) is connectionless.
You cannot reserve bandwidth in advance.
ATM is connection-oriented.
You declare your needs before using the network.
- ❑ Switching: In IP, each packet is addressed and processed individually.
- ❑ Cells: Fixed size or small size is not important

Binary Rate Scheme

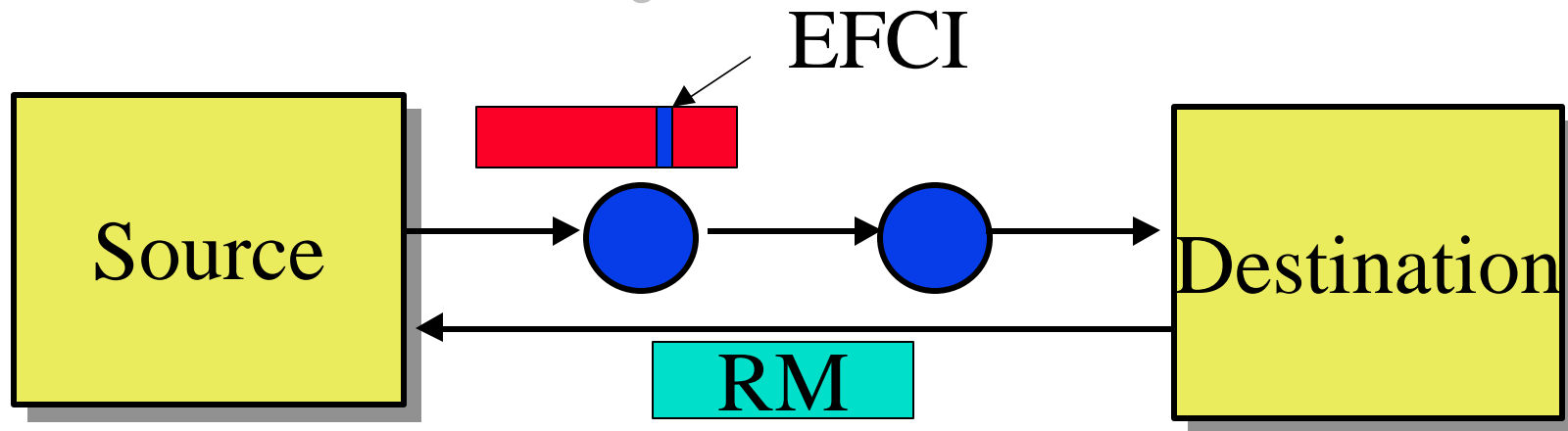

- ❑ DECBit scheme in many standards since 1986.
- ❑ Forward Explicit Congestion Notification (FECN) in Frame relay
- ❑ Explicit Forward Congestion Indicator (EFCI) set to 0 at source. Congested switches set EFCI to 1
- ❑ Every n th cell, destination sends an resource management (RM) cell to the source

The Explicit Rate Scheme

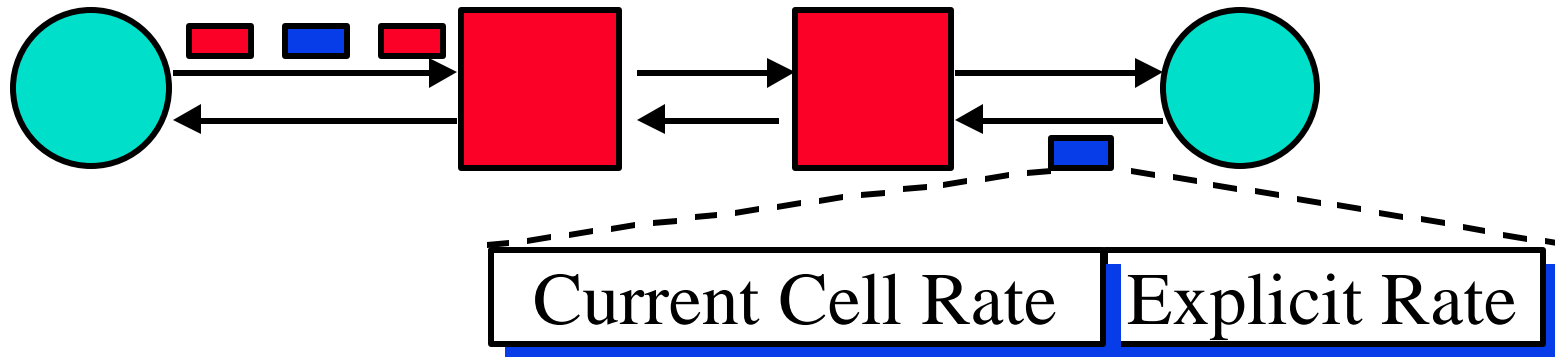

- ❑ Sources send one **RM cell** every n cells
- ❑ The RM cells contain “**Explicit rate**”
- ❑ Destination returns the RM cell to the source
- ❑ The switches adjust the rate **down**
- ❑ Source adjusts to the specified rate

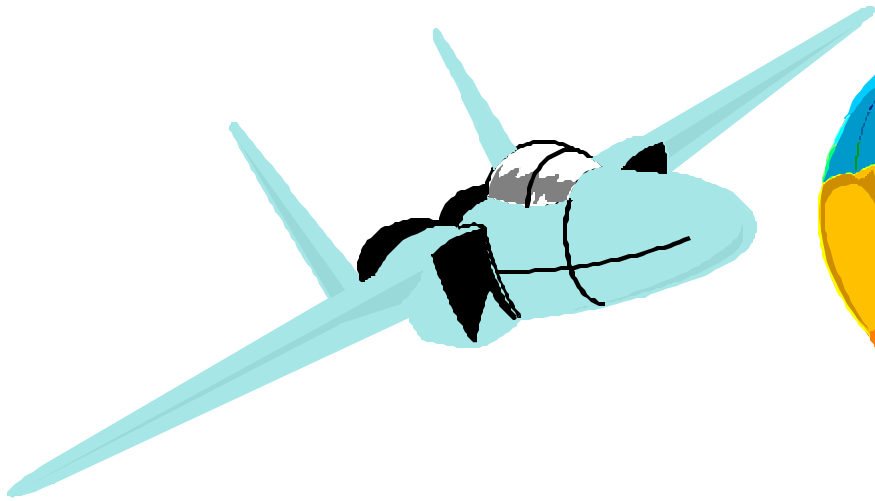

Go
30 km East
35 km South

Go left

Why Explicit Rate Indication?

- Longer-distance networks
 - ⇒ Can't afford too many round-trips
 - ⇒ More information is better
- Rate-based control
 - ⇒ Queue length = $\Delta\text{Rate} \times \Delta\text{Time}$
 - ⇒ Time is more critical than with windows

5 Ways to Improve ABR over Satellite

1. Increase the limit on the number of outstanding cells before decreasing
(\Rightarrow Large Transient Buffer Exposure (TBE) parameter. The size of was increased from 8 bit to 24 bit to accommodate satellite paths.)
2. Use larger Rate Increase Factor (RIF)
 \Rightarrow RIF=1 \Rightarrow Fast transient Response
3. Implement Backward Explicit Congestion Notification (BECN)
4. User larger ACR Decrease Time Factor (ADTF)
5. Implement Virtual Source/Virtual Destination (VS/VD)

VS/VD: Results

- Without VS/VD:

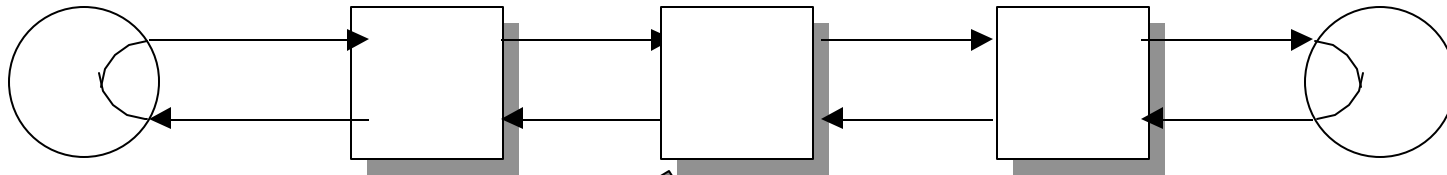

- With VSVD:

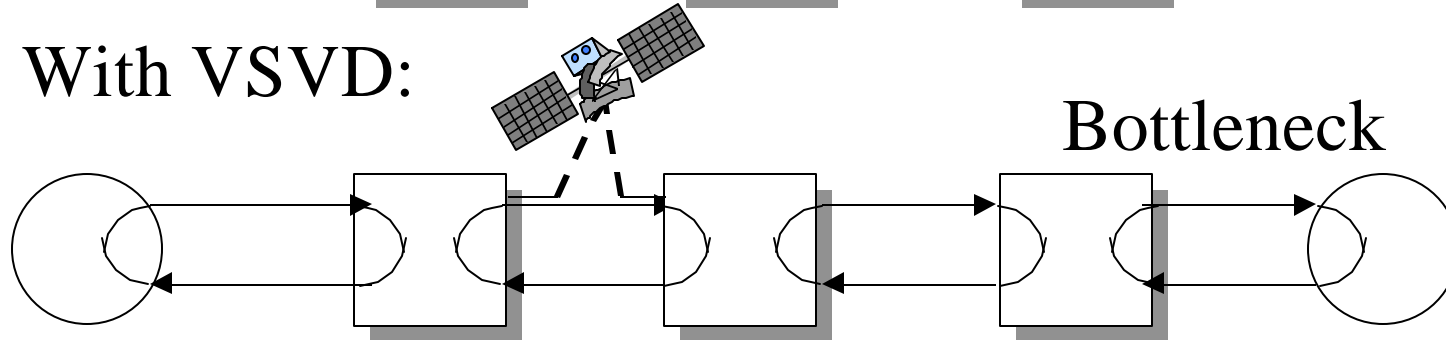

Satellite
Link

Workgroup
Switch

- With VSVD, the buffering is proportional to the delay-bandwidth of the previous loop
⇒ Good for satellite networks

ABR or UBR?

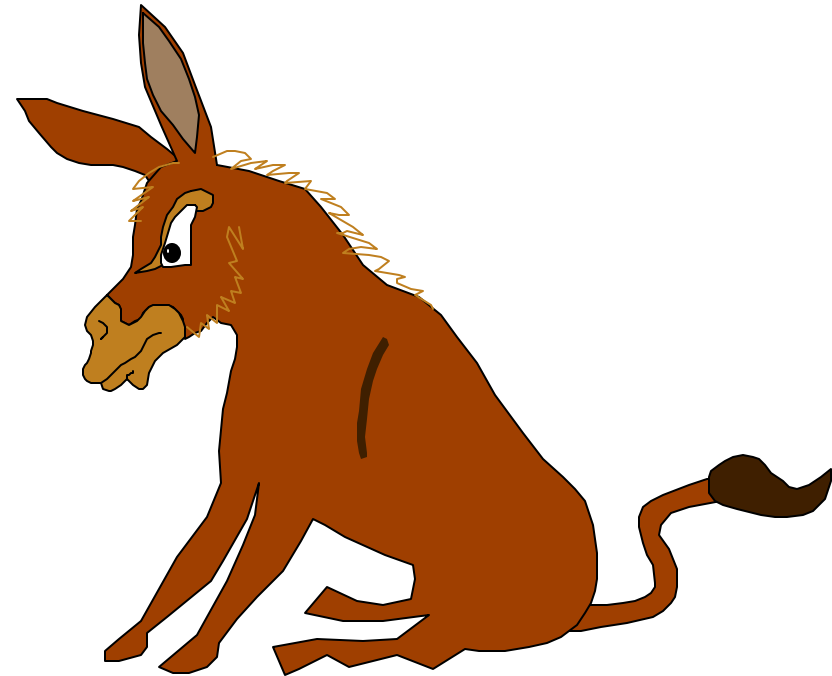
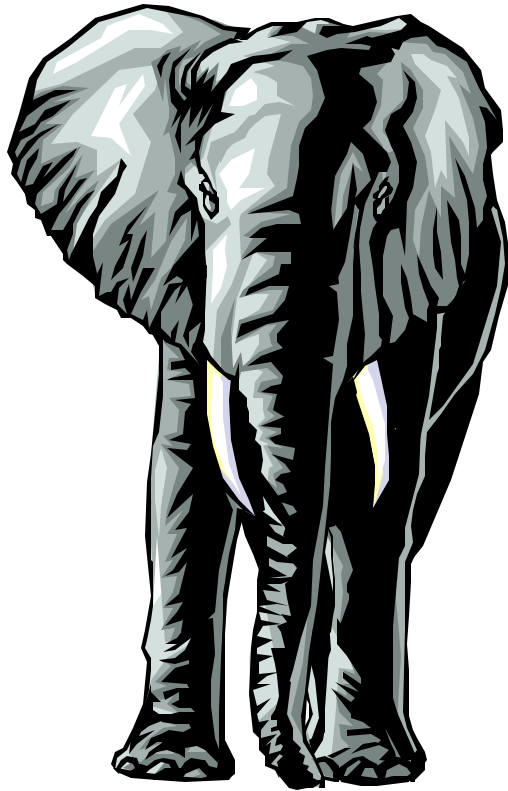

- Intelligent transport or not?

4 Ways to Improve UBR over Satellites

1. Implement “Selective Acknowledgement” in end-systems
2. Disable “Fast retransmit and recovery” in end-systems
3. Reserve a small fraction of bandwidth for UBR in the switches. For WANs, the effect of reserving 10% bandwidth for UBR is more than that obtained by other buffer management policies. .
4. Fix slow start implementations in end-systems to avoid errors due to integer arithmetic

Old House vs New House

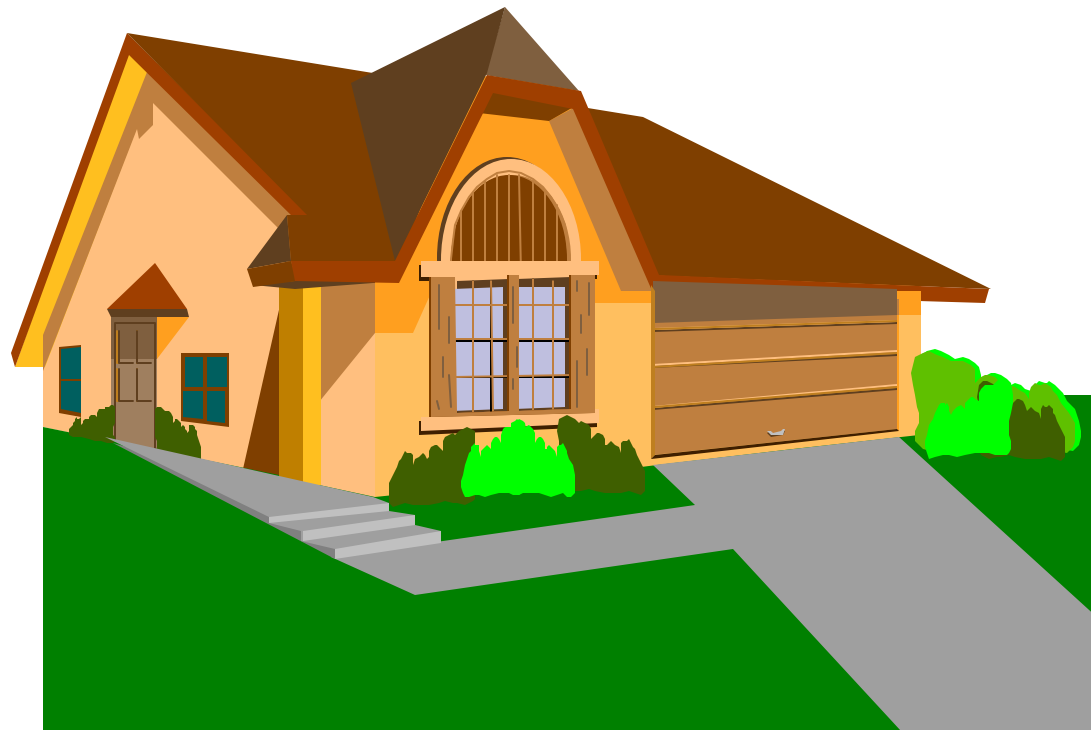

New needs:

Solution 1: Fix the old house (cheaper initially)

Solution 2: Buy a new house (pays off over a long run)

Traffic Management in TCP/IP

- ❑ Loss based:
 - If a segment times out, TCP reduces its window to 1
 - TCP starts with a window of 1 and increases if nothing is lost
 - Not tuned for large windows in satellite networks
- ❑ Selective drop policies, e.g., Random Early Discard (RED) affect fairness not throughput
- ❑ Selective Acknowledgement helps in satellite networks
- ❑ Explicit Congestion Notification (binary feedback) is being introduced but needs new algorithms
- ❑ Multiprotocol Label Switching may help for TCP/UDP

Multiprotocol Label Switching

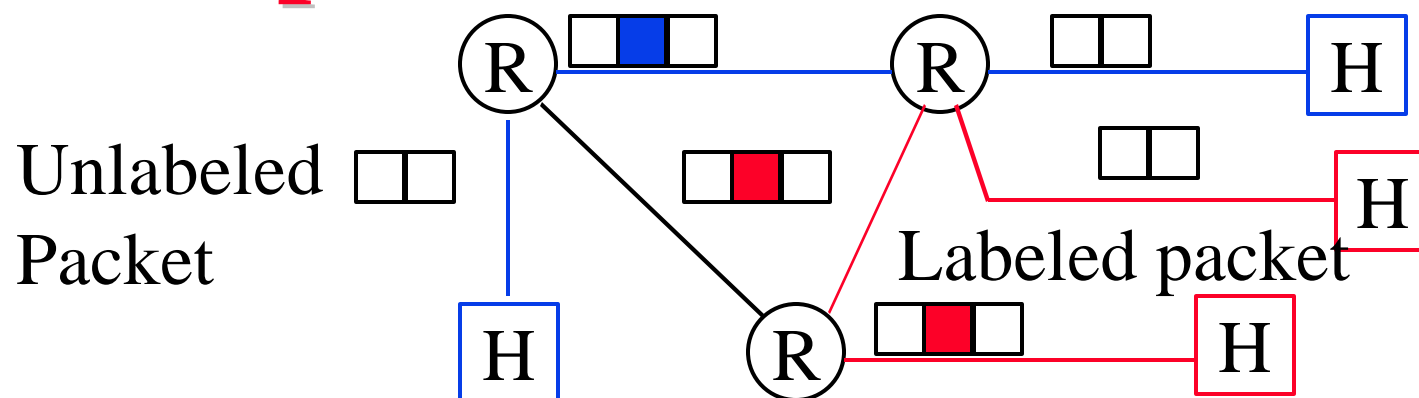

- ❑ First router attaches a 'label' (virtual circuit number) to the packet
- ❑ Other routers switch packets based on labels
Do not need to look inside \Rightarrow Fast.
- ❑ Label + 3 experimental bits are used to determine the queue (quality of service)
- ❑ Last router strips off the label

Traffic Engineering Using MPLS

- ❑ Packets with the same label = Label Switched Path
⇒ Same path
- ❑ Packets with the same label+Experimental bits = Trunks ⇒ Same path and QoS
- ❑ “Traffic Trunks” = Switched Virtual Circuits
⇒ Traffic trunks are routable entities like VCs
- ❑ Multiple trunks can be used in parallel to the same egress.
- ❑ Each traffic trunk can have a set of associated characteristics, e.g., priority, preemption, policing, overbooking

MPLS Simulation Results

- ❑ Total network throughput improves significantly with proper traffic engineering
- ❑ Congestion-unresponsive flows (UDP) affect congestion-responsive flows (TCP)
 - Separate trunks for different types of flows
- ❑ Trunks should be end-to-end
 - Trunk + No Trunk = No Trunk

Reference: P. Bhaniramka, et al, “*QoS using Traffic Engineering over MPLS: An Analysis*,” IETF draft-bhani-mpls-te-anal-00.txt, March 1999, <http://www.cis.ohio-state.edu/~jain/teanal.htm>

Summary

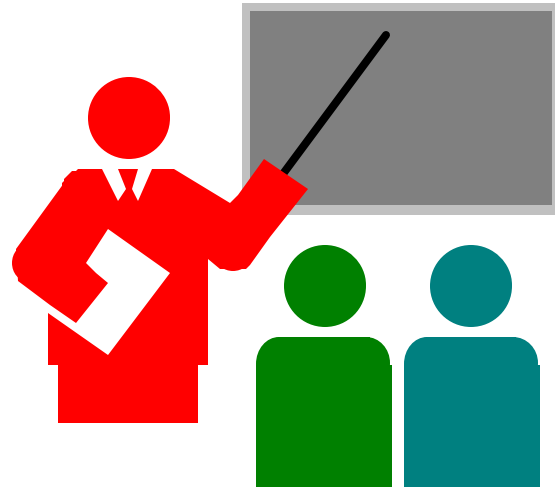

- ❑ Traffic management is required for high-bandwidth delay product satellite networks
- ❑ Explicit Rate based traffic management in ATM is required for high bandwidth delay product networks
- ❑ MPLS appears to be the most promising approach for traffic engineering in IP networks

Our Contributions and Papers

- All our contributions and papers are available on-line at <http://www.cis.ohio-state.edu/~jain/>