

Tri-Band RF Transceivers for Dynamic Spectrum Access

By

Nishant Kumar and Yu-Dong Yao

Presentation outline

- Introduction to WISELAB
- Active work at WISELAB
- Tri-band test bed
- Elements of the test bed
- Experimentation
- Conclusion

Wireless Information System Engineering Lab (WISELAB)

- Part of Electrical and Computer Engineering department of Stevens Institute of Technology
- It was started for the purpose of exploration of advances in wireless communication systems.
- Active work include performance analysis, algorithm development and experimentation.
- Seeks to improve signal transmission performance and increase system capacity of existing wireless technologies.

Current work

- Software Defined Radio for Dynamic Spectrum Access
- Tri-Band Test bed for Dynamic Spectrum Access
- Wireless Drifter for Homeland Security: Harbor Protection
- Wireless Security: LP Performance of chaotic Signals
- Antenna Array and beam forming
- Wireless Packet access protocols

Software Defined Radio for Dynamic Spectrum Access

Objectives:

- Do Software radio, cognitive radio and dynamic spectrum access
- Do Spectrum and interference measurement
- Development and testing of interference avoidance and channel access protocols

Sponsors:

- Stevens/WISELAB research seed funding
- WiNSeC
- NSF NETS Program (2004 – 2005)

SDR platforms

FlexRadio:

- Frequency range: 0-65 MHz
- Transmit frequency range: 1.8-2.0, 3.525-3.75, ..., 50.1-54.0 MHz (CW, RTTY/data, phone, image)
- Maximum bandwidth: 40 KHz
- Transmit power: 1W RMS (max.)
- Transmission mode: Simplex
- Operating system: Windows 2000/Windows XP
- VB/C# programming for implementation/testing

Vanu Radio: Full duplex 900 MHz RF; 5 MHz bandwidth

Comblock: Dual band (900 MHz and 2.4 GHz); 10/20 Mbps (BPSK/QPSK)

User Interface

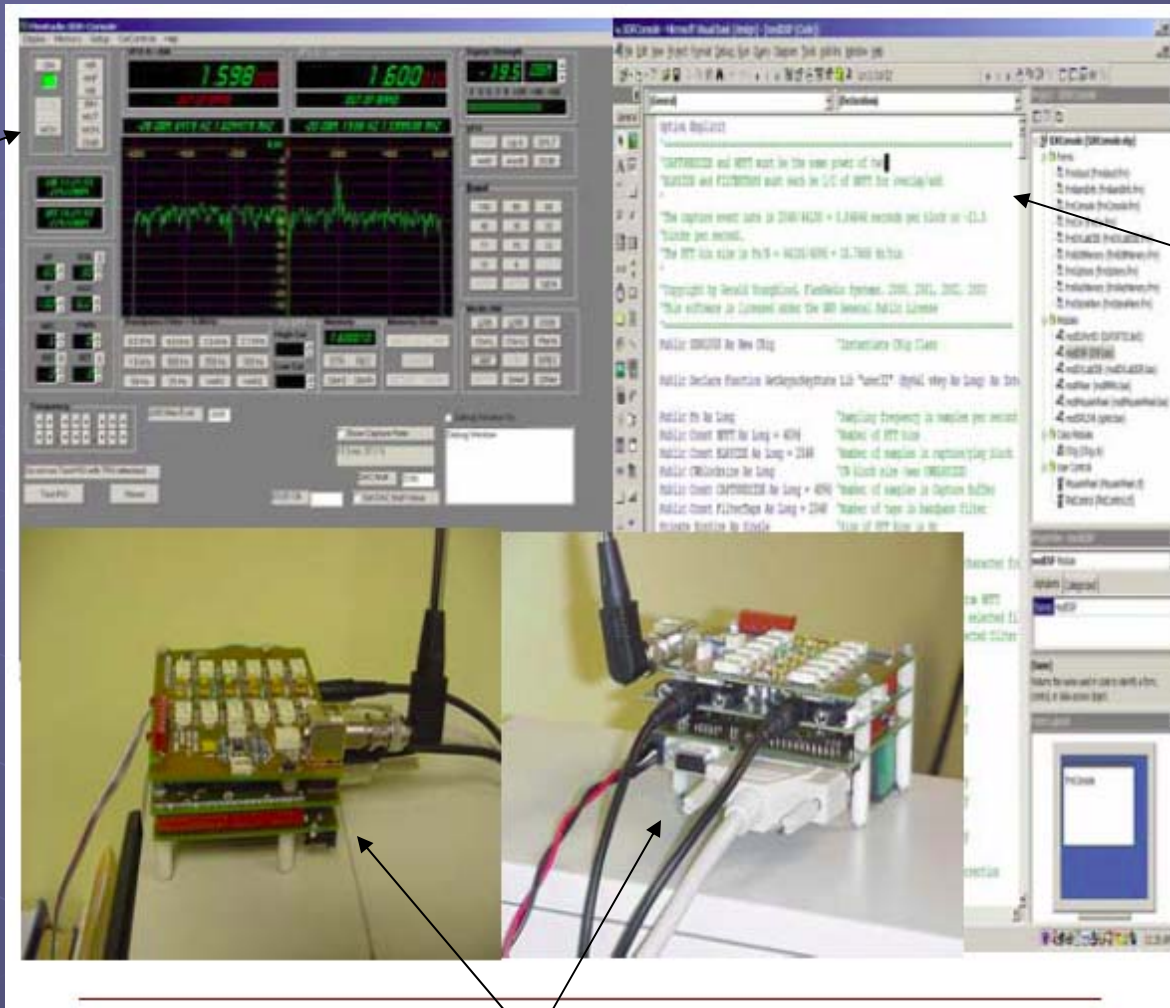

Source code

RF Front End

FlexRadio based SDR

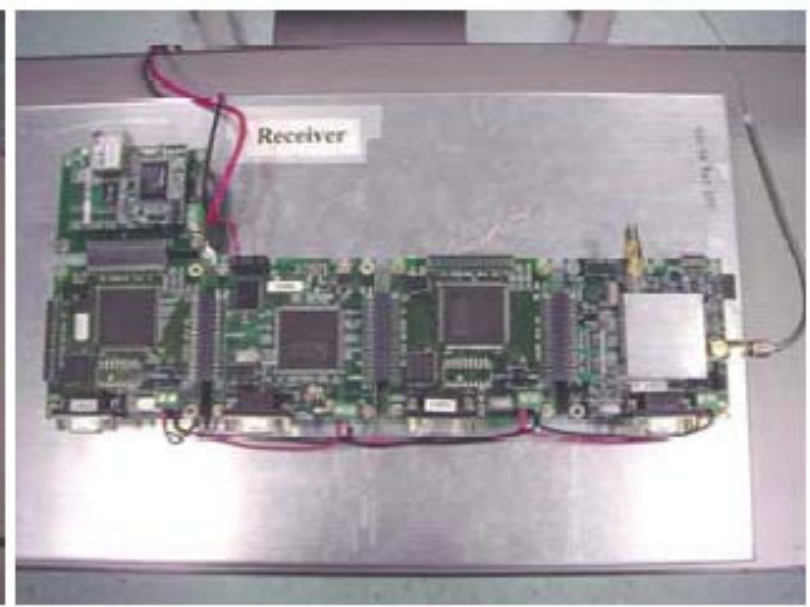
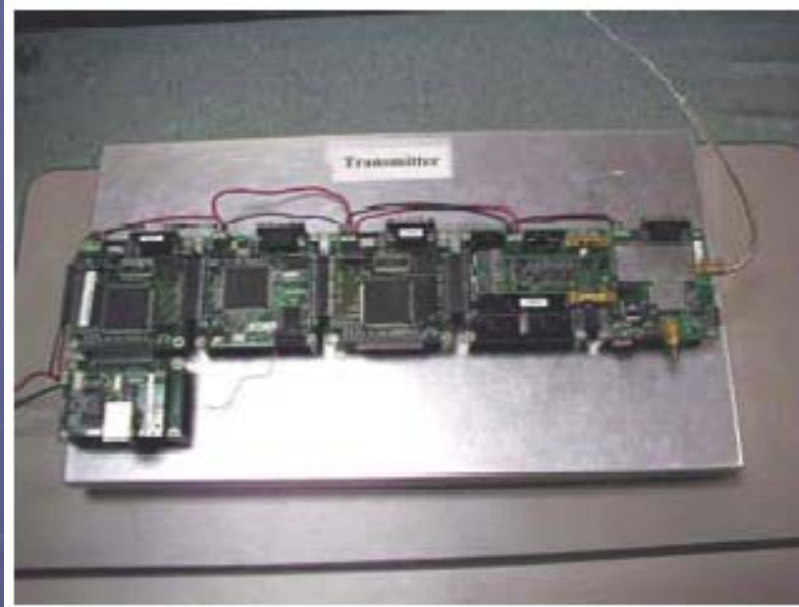

COMBLOCK based RF front end

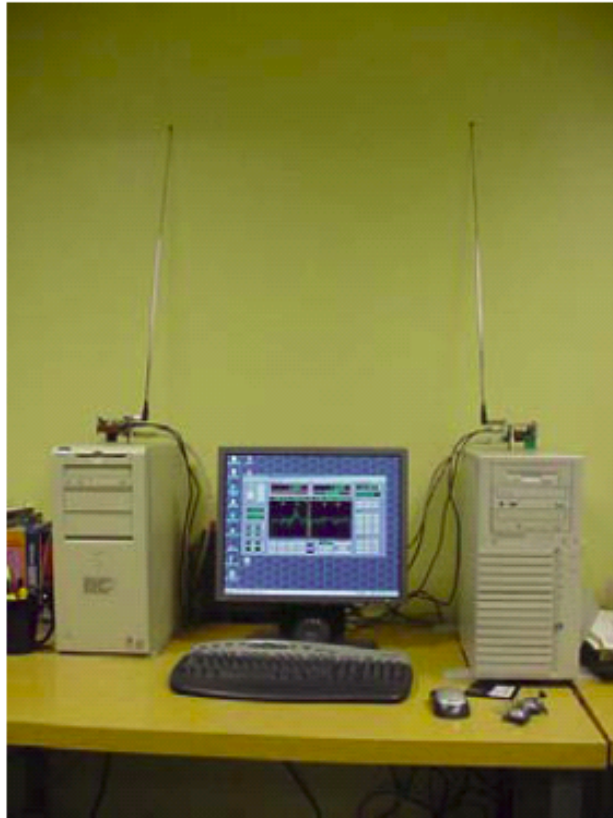

Beamforming algorithm implementation using SDR

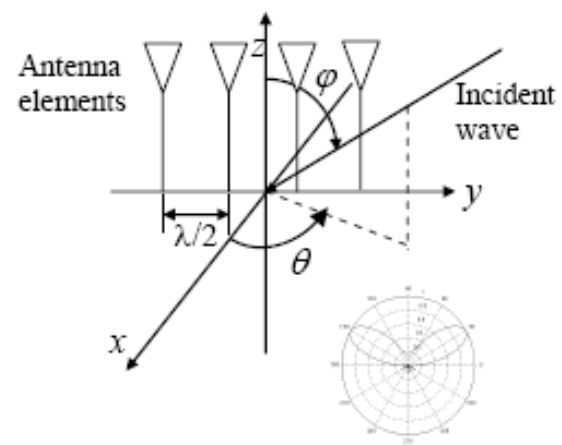

Antenna array

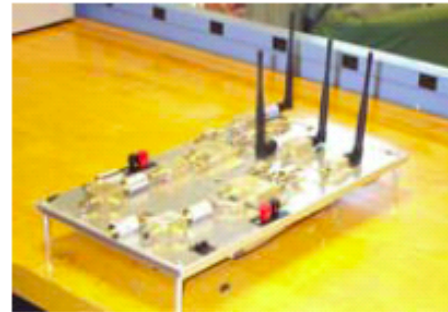

RF front end

Tri-Band Test Bed

Objective:

- Development of a multi-band, multi-channel wireless test bed
- Exploration of ISM band
- Development of dynamic spectrum access systems

Sponsors:

- Stevens' Scholar Program (Summer 2003)
- WiNSeC
- NSF NRT Program (2003 – 2004)
- NSF NETS Program (2004 – 2005)

ISM band

- Introduced by FCC in 1980 for unlicensed use of RF electromagnetic fields for industrial, scientific and medical use.
- The end user doesn't need to obtain permission but the equipment is governed by rules made in respect to the transmission technologies and power.
- Commonly used bands encompass the frequency ranges 902 - 928 MHz, 2400 - 2483.5 MHz, and 5725 - 5850 MHz.

Tri-band test bed

Receiver Leg

Base band
output

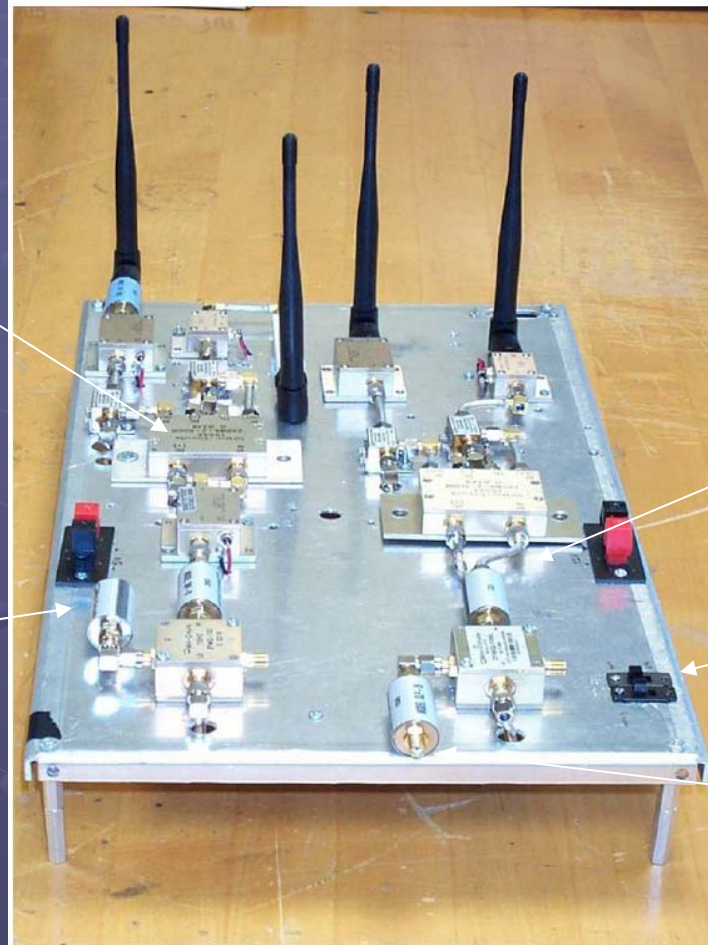

Transmitter Leg

Band Selection
Switch

Base band
input

Block diagram

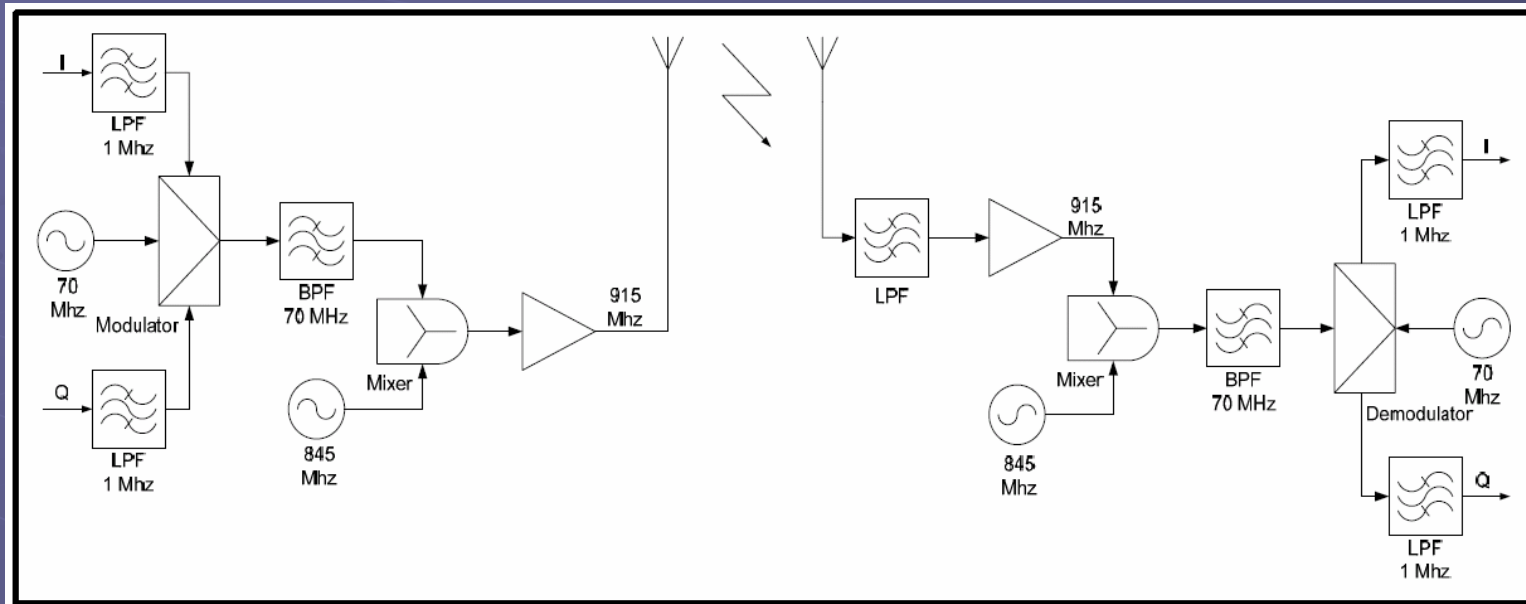

Transmitter:

- 1 MHz Base band modulated to IF (70 MHz)
- IF (70 MHz) + LO (845 MHz) = RF (915 MHz)

Receiver:

- RF (915 MHz) – LO (845 MHz) = 70 MHz
- 70 MHz IF demodulated to 1 MHz base band

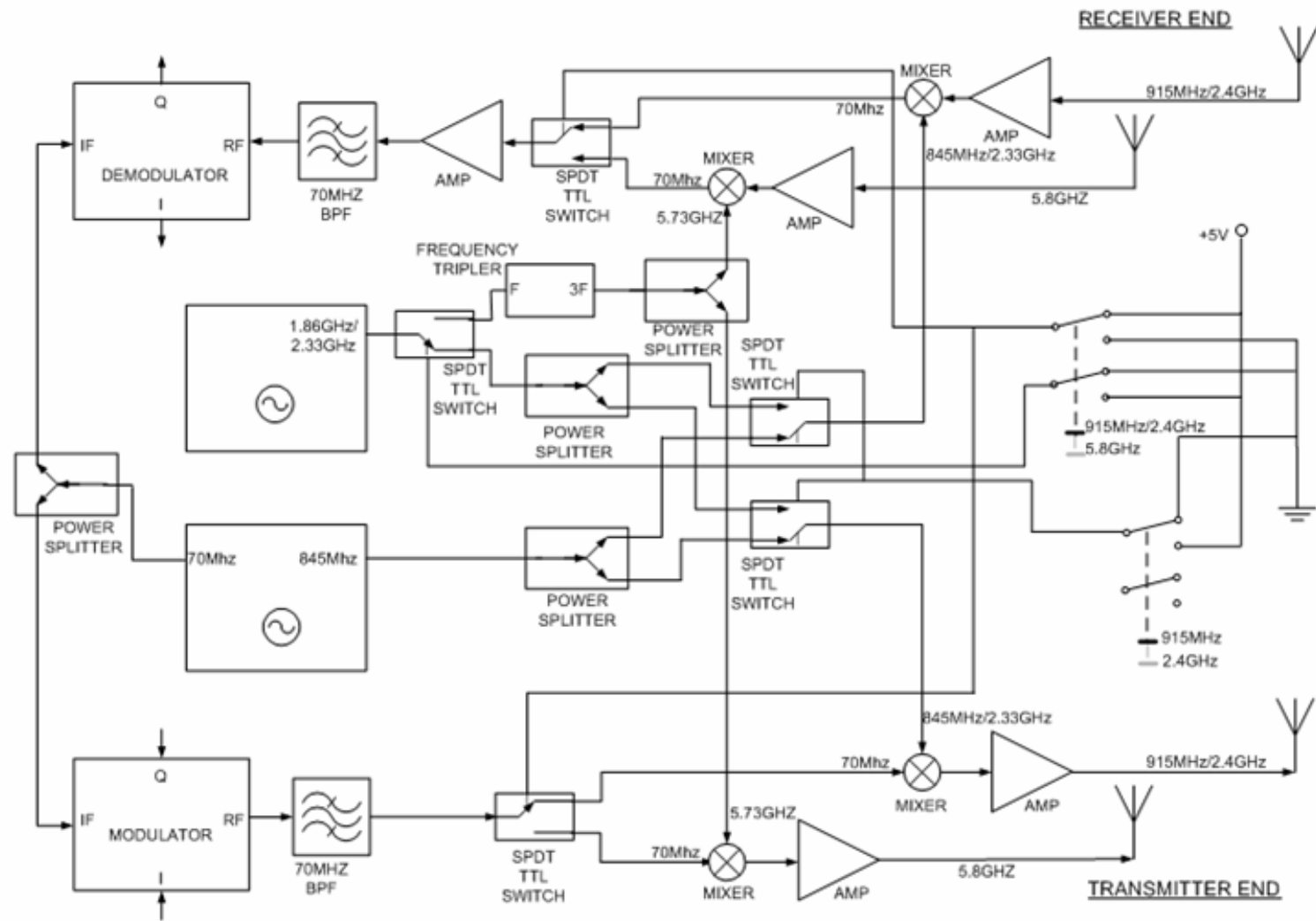

BLOCK DIAGRAM

Features

- Operate in three ISM bands (900 MHz, 2.4 GHz, 5.8 GHz)
- Convenient to perform testing at every frequency stage
- Low MDS (minimum detectable signal) (e.g., -62dBm)
- Better LO stability (e.g., +/- 1 ppm, +/- 2.5 ppm)
- Band switch through microcontroller
- Serial communication port for LO frequency Selection

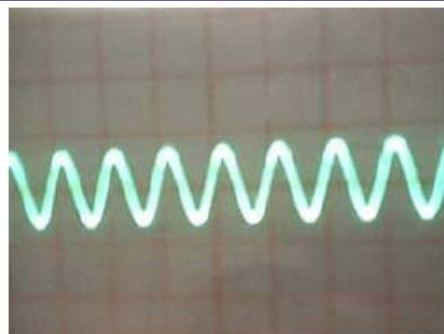

Fig. 4 (a). Input signal.

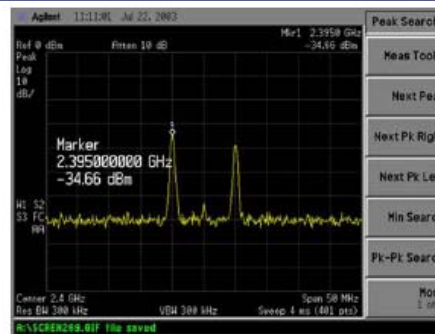

Fig. 4 (d). Signal transmitted.

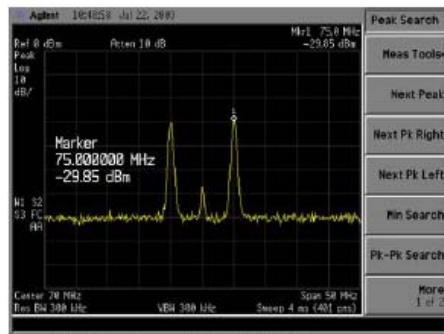

Fig. 4 (b). Signal modulated to 70 MHz.

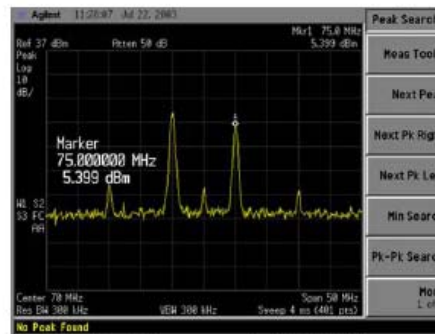

Fig. 4 (e). Signal down-converted to 70 MHz.

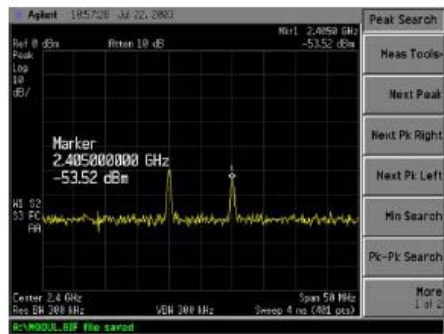

Fig. 4 (c). Signal up-converted to 2.4 GHz.

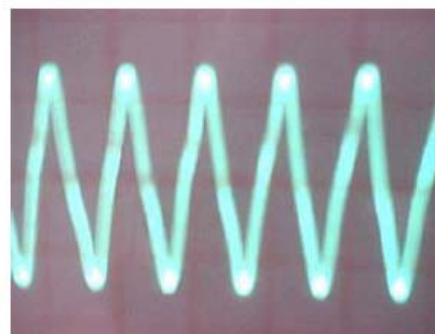

Fig. 4 (f). Output signal.

DSA application

- The Tri-band can be controlled by a microcontroller or a PC.
- The bands are selected by the band selection digital input
- The channel are selected through serial communication with LO.
- The algorithm for scanning and channel accessing is achieved through software.
- Advance channel selection algorithm is done through SDR which can be based on BER, noise level, etc.



Tri-band test bed Integration with other systems

Wireless Drifter for Homeland Security: Harbor Protection

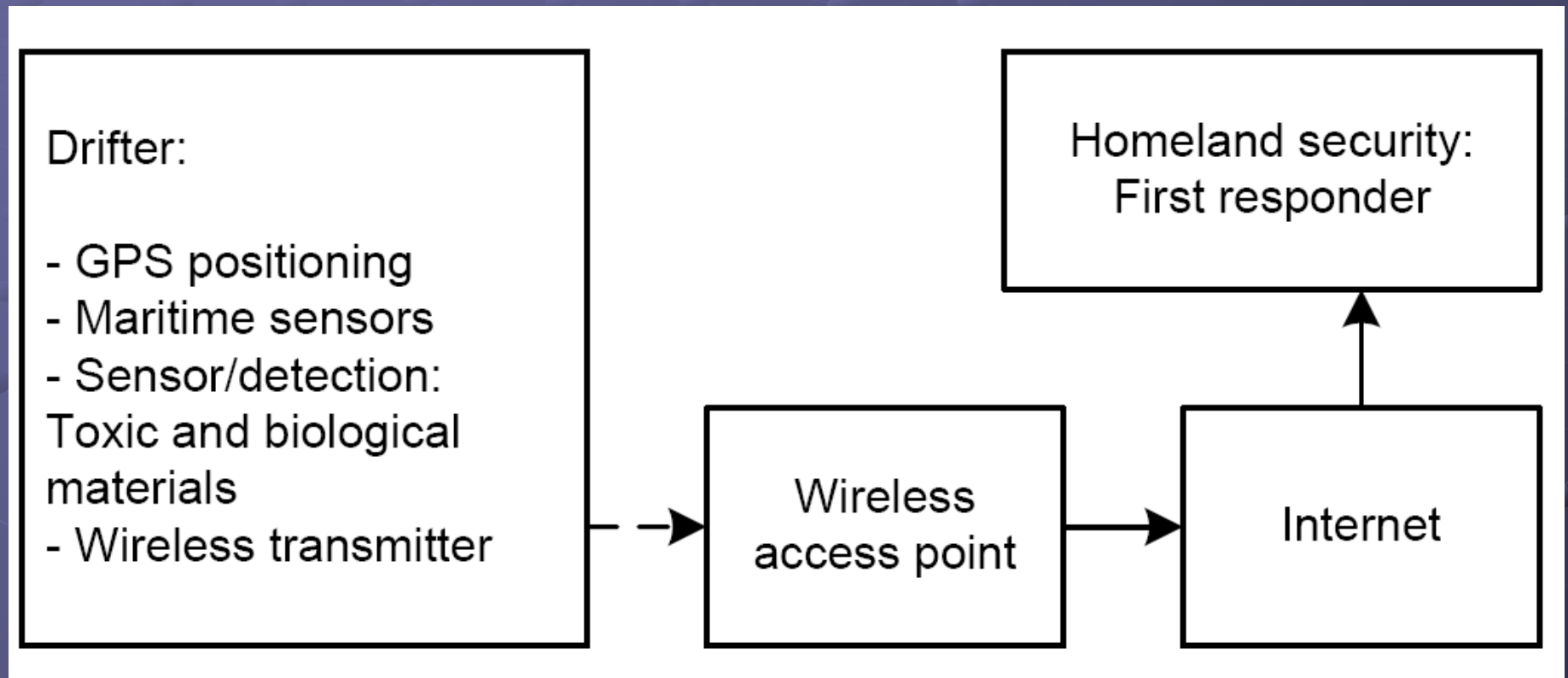

Application scenario

Elements of Wireless Drifter

- Sensor (temperature, light, magnetic field, pressure)
- Tri-Band testbed

Radio transceiver:

- 900 MHz ISM band
- Baud rate from 1200 to 38400 bps
- Indoor/urban range 300 ft.; LOS 1000 ft.
- Robust performance even at 1mW output power
- Point-to-point, point-to-multipoint network topology

Microcontroller

- 10-bit 100 KSPS ADC
- 2 KB internal data RAM and 32 KB flash
- Up to 25 MIPS with 25 MHz clock

GPS

Web graphical interface

System and Elements

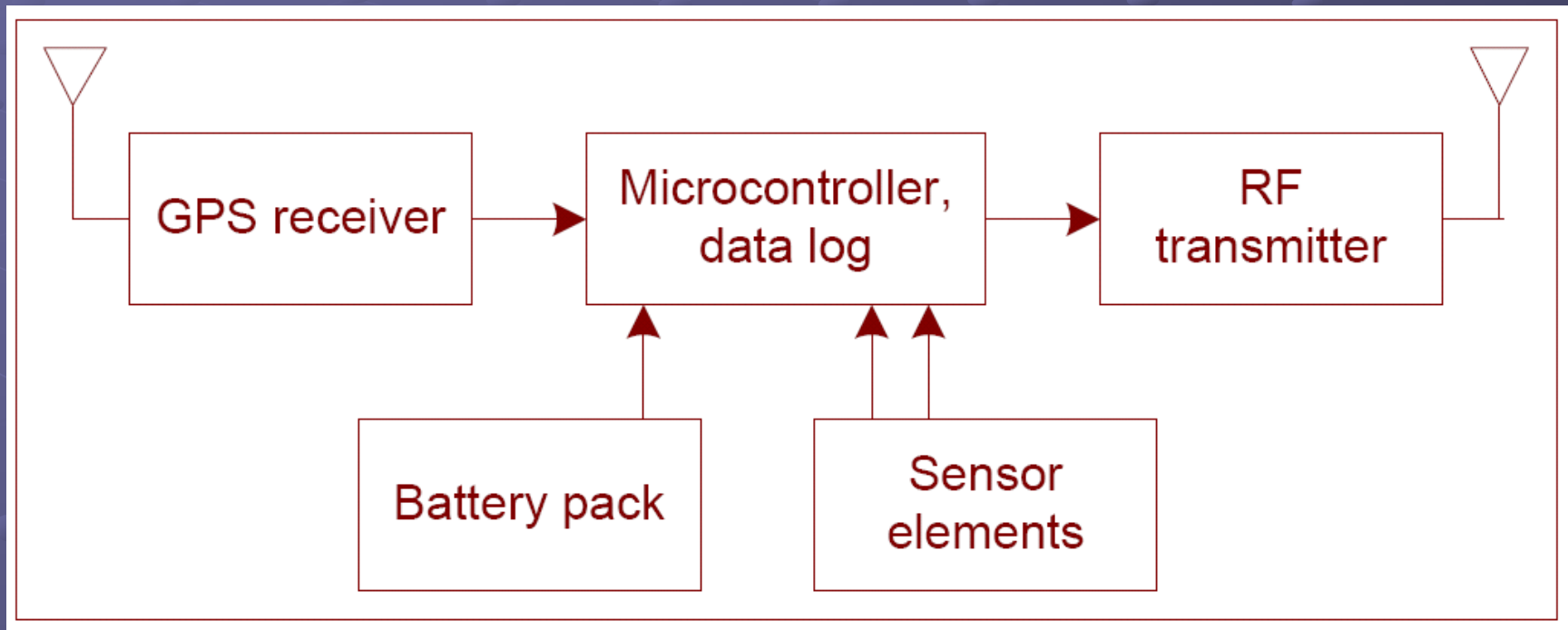

Hardware and Trial

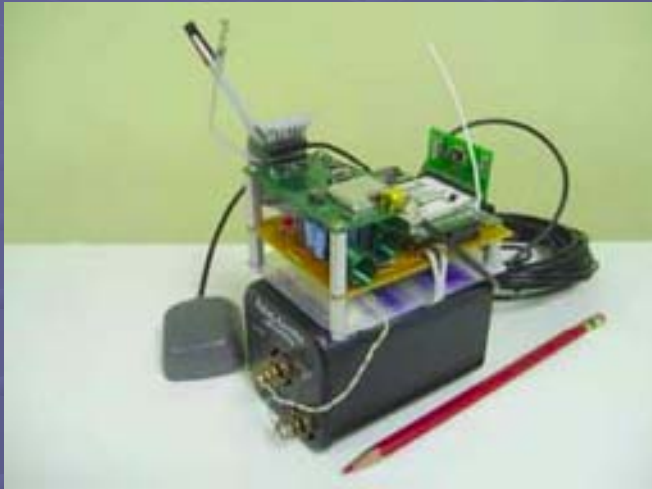

Field trials

Work in progress

- Solar power
- Hydrophone (audio signal detection)
- Maritime sensors
- Sensor/detection for homeland security: Toxic and biological materials
- WLAN connection; Full duplex RF links
- Satellite connection
- Ad hoc network

Sponsors

- Stevens' Office of Technology Initiatives (2004 – 2005)
- WiNSeC
- Office of Naval Research(ONR) (2005 – 2006)

Conclusion

- WISELAB
- Various initiative at WISELAB
- Tri-band Test bed
- Elements of Tri-band Test bed
- Experiments
- Dynamic Spectrum Access
- Mobile application of Tri-band test bed

Thank you

Question?