

Radio Communications for Emergency Responders in High-Multipath Outdoor Environments

Kate A. Remley, Galen Koepke, Christopher L. Holloway,
Chriss Grosvenor, Dennis G. Camell, and Robert T. Johnk²

National Institute of Standards and Technology, Boulder, CO 80305 USA
2. Institute for Telecommunication Sciences, Boulder, CO 80305 USA

Contact: remley@boulder.nist.gov, 303-497-3652

Wireless technology

Responders would like to use new wireless technology *reliably*

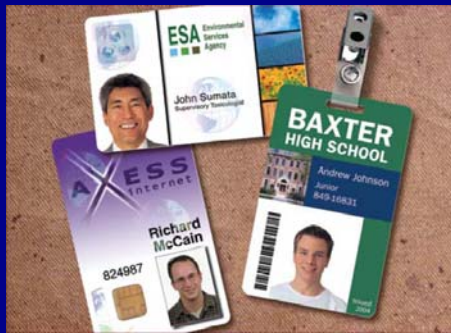

Unique needs of emergency responder community:

- Large public buildings
- Tunnels, parking garages, basements
- Factories, refineries, utility plants



Wireless environment for emergency responders

NIST project to gather propagation data in large public structures

- Large body of measured data in open literature
- Interpretation of key environmental effects
- Development of performance metrics, lab-based tests
- Support for standards development efforts
- Funded by DOJ Community-Oriented Policing Services and DHS Office of Standards

Wireless environment for emergency responders

Measurements consist of:

- Received signal strength at key frequencies
- Wideband excess path loss, RMS delay spread
- Modulated-signal measurements

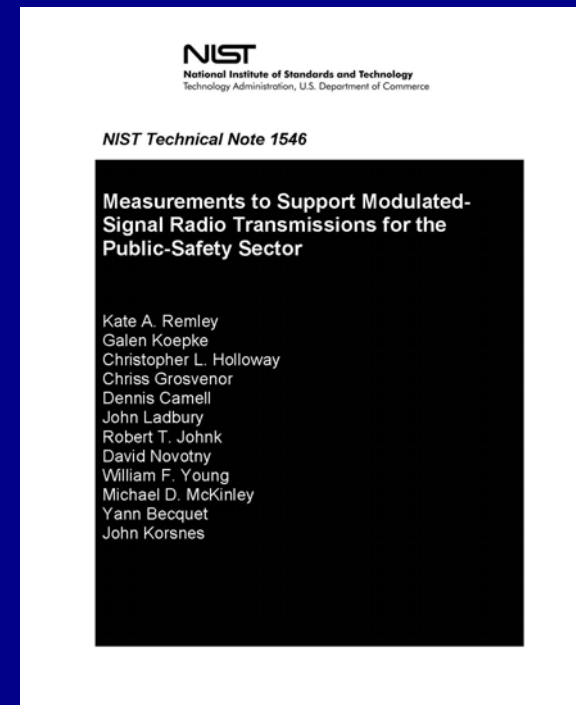
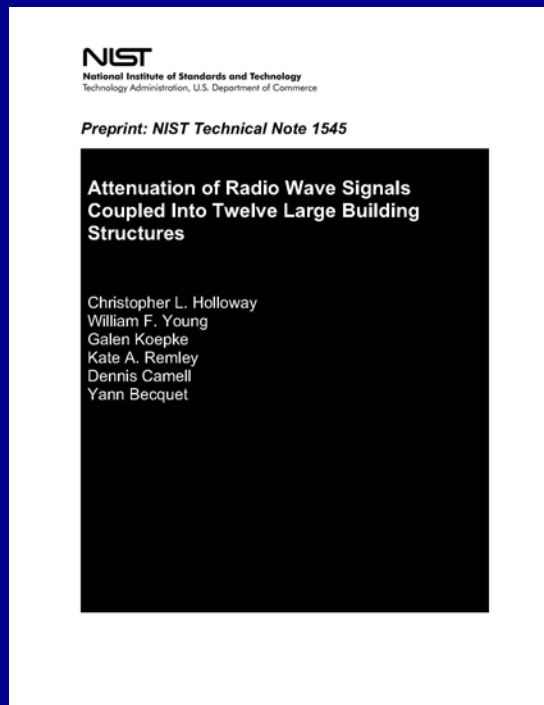

Wireless environment for emergency responders

Building Structures:

- Five office buildings
- One supermarket
- One large shopping mall
- One large sports stadium
- One hotel/small convention center
- One large convention center
- Oil refinery
- One large apartment building
- Subterranean tunnel
- Office building corridor



Radiowave penetration in large public buildings

Standing structures

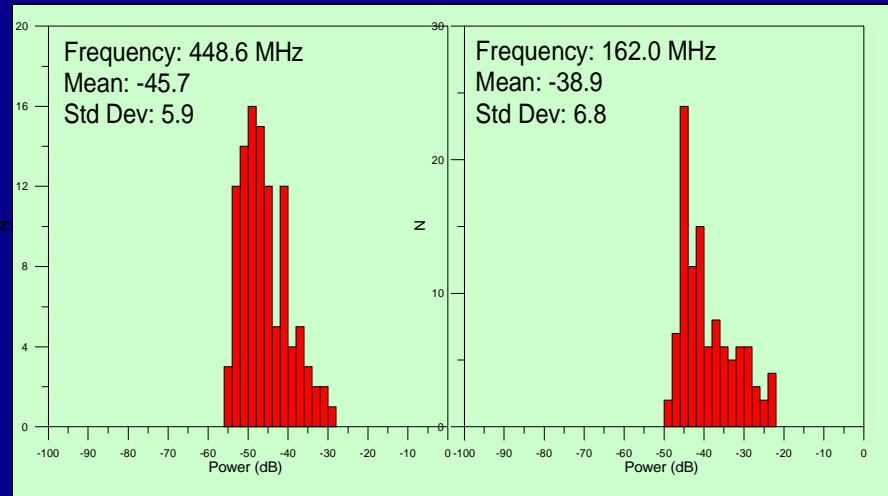

Radiowave penetration in large public buildings

Collapsed buildings



14-story apartment building
New Orleans
January 2004



Old Convention Center
Washington, D.C.
December 2004



Veteran's Stadium
Philadelphia
March 2004

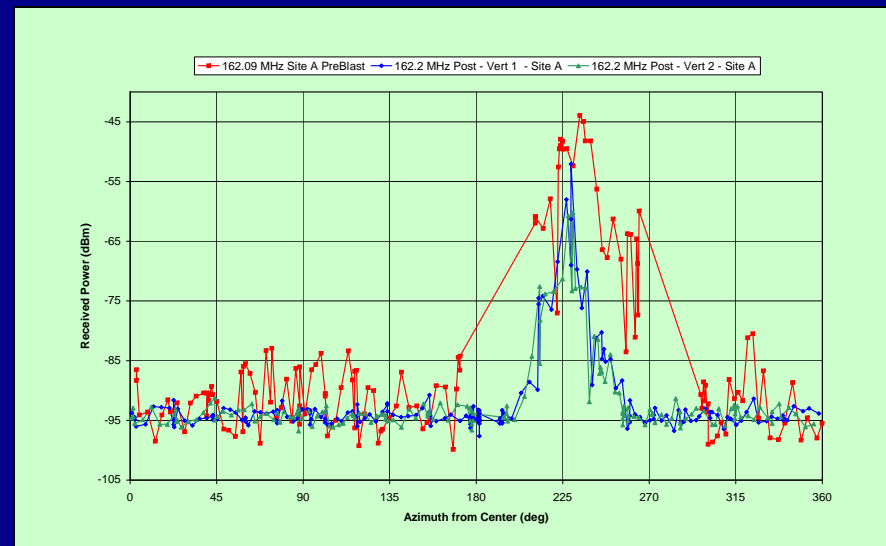

Tests in oil refinery



- Open structure
- Tunnel-like behavior

Difficult radio environment

- Metal surfaces, heavy equipment
- Large footprint
- Mobile machinery and users



Test set-up mimics incident deployment



Base site outside facility:

- Equipment located in van, fixed location



Responder site moves through facility:

- Single frequency
- Broadband UWB (synthetic pulse)
- Modulated Signal

Received signal strength measurements

Radios are tuned to public safety frequencies and carried throughout buildings. Data recorded continuously.

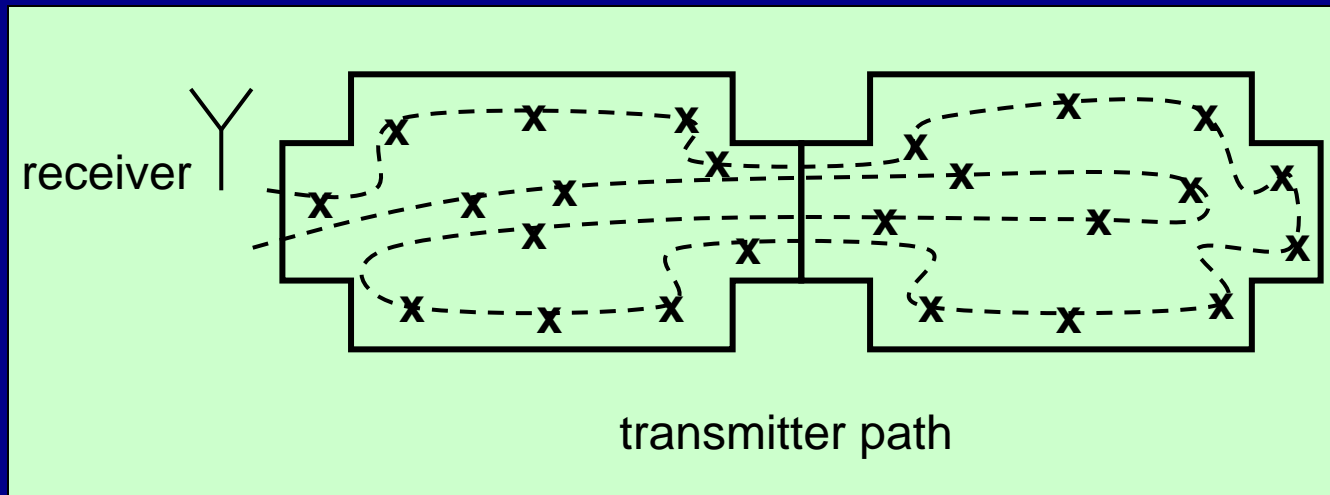
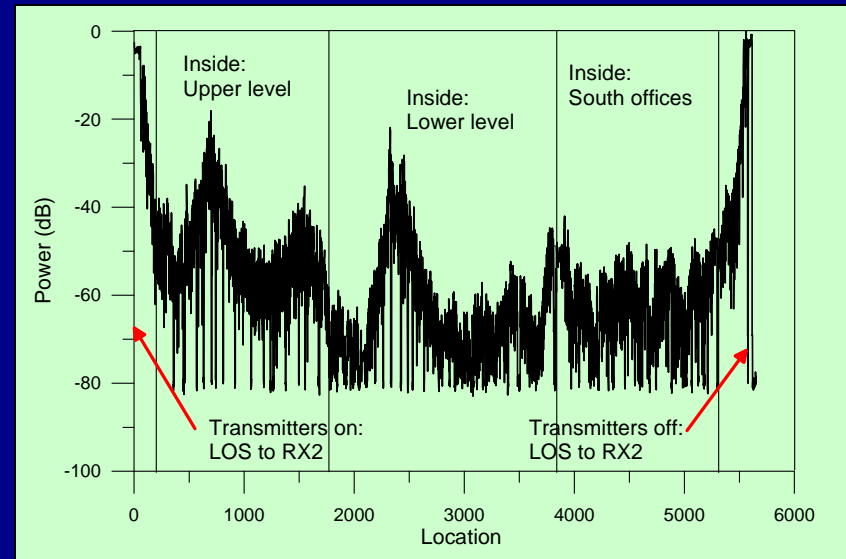

Calibrated receiver system

Allows researchers, emergency responders to study difficult radio environments

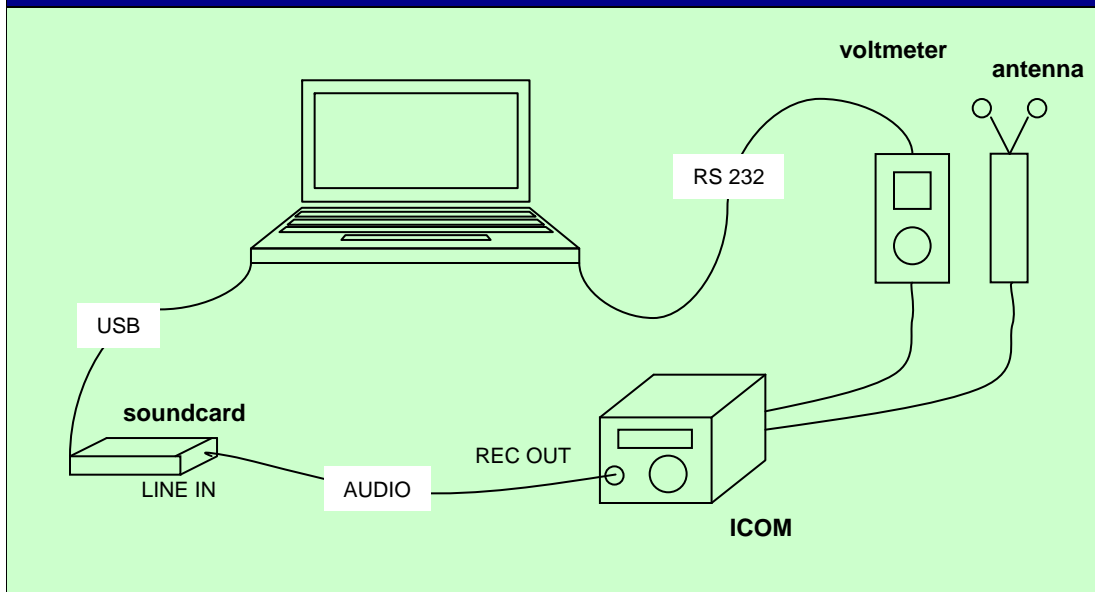

Commercially available receiver and PC sound card are inexpensive and straightforward to use

Increased dynamic range

- Morse Code signals illustrate concept
- Narrowband detection picks signals out of noise

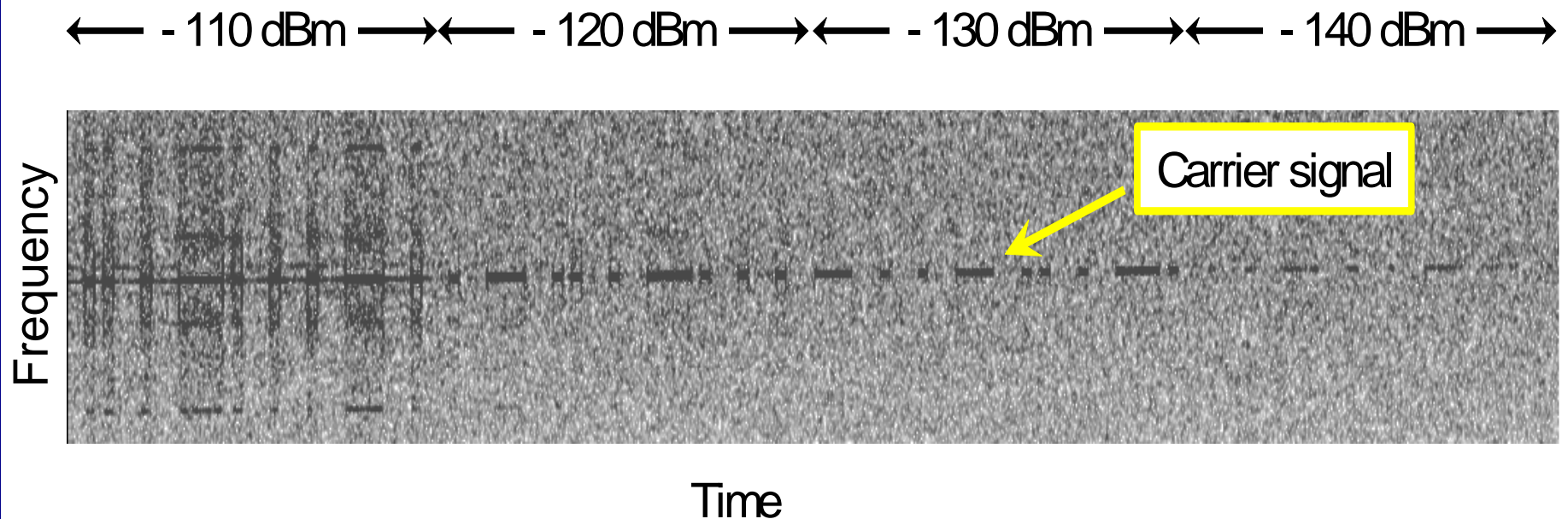

Receiver data

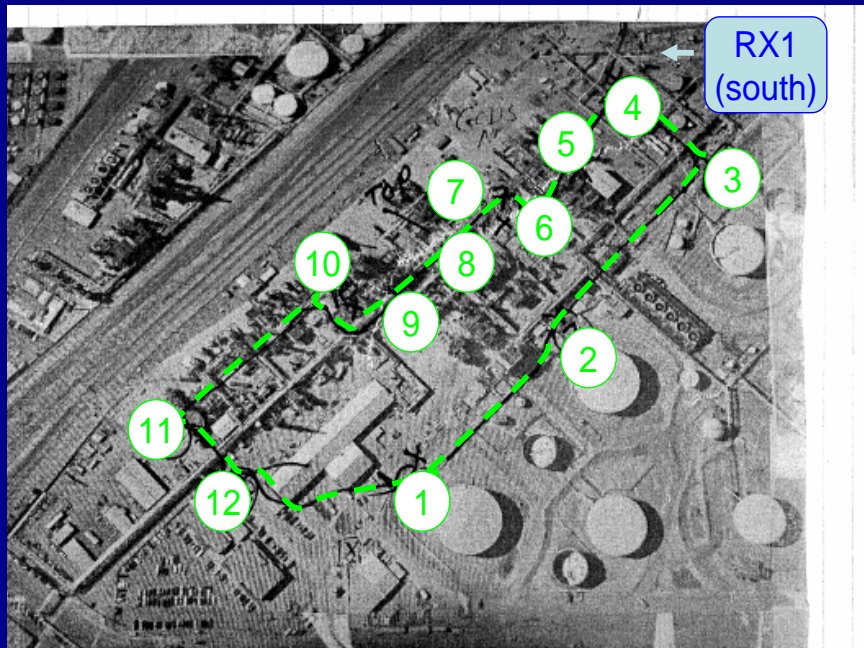

Walk Through

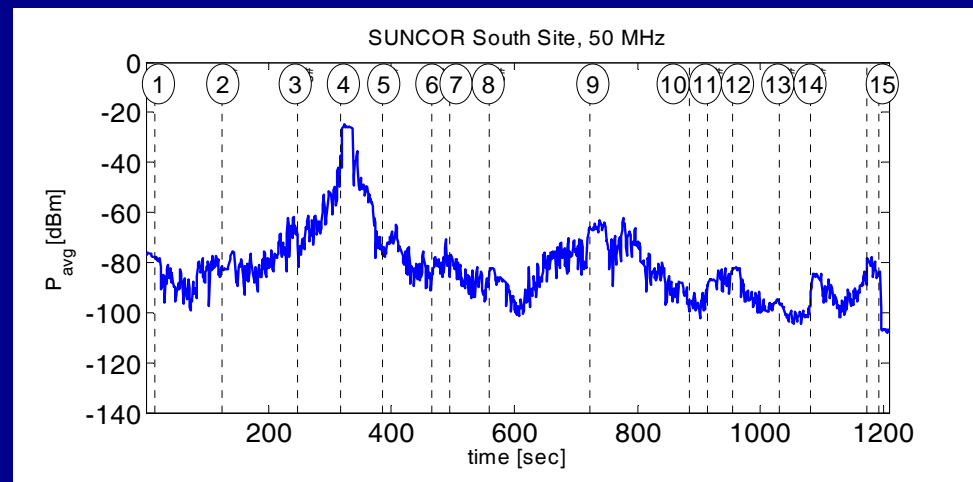

50 MHz

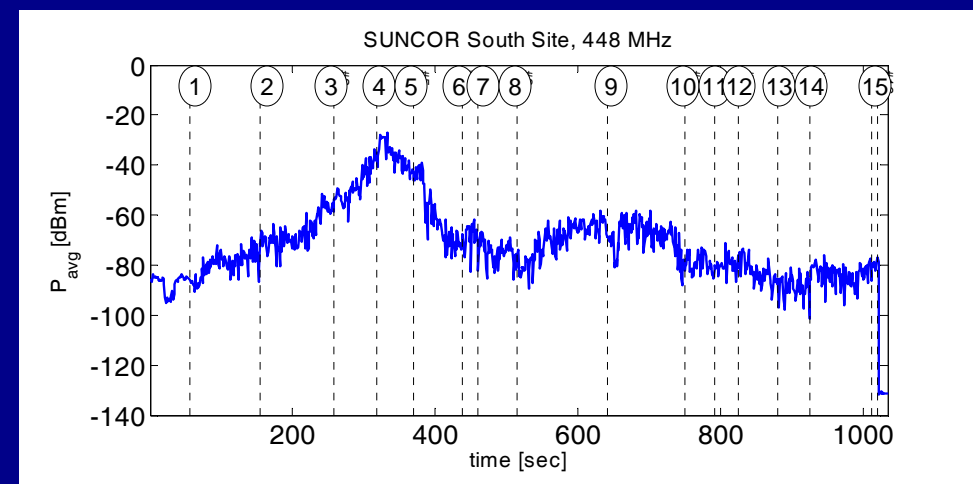

448 MHz

Receiver data



Drive around perimeter

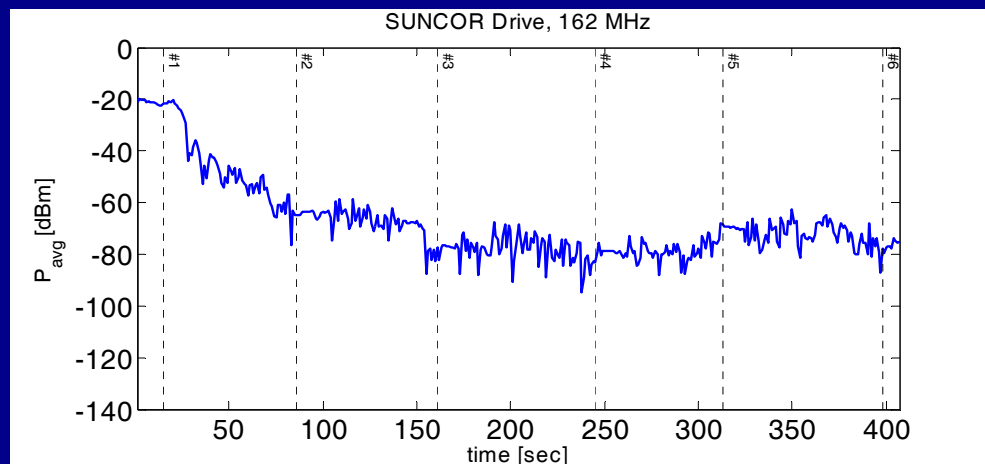

162 MHz

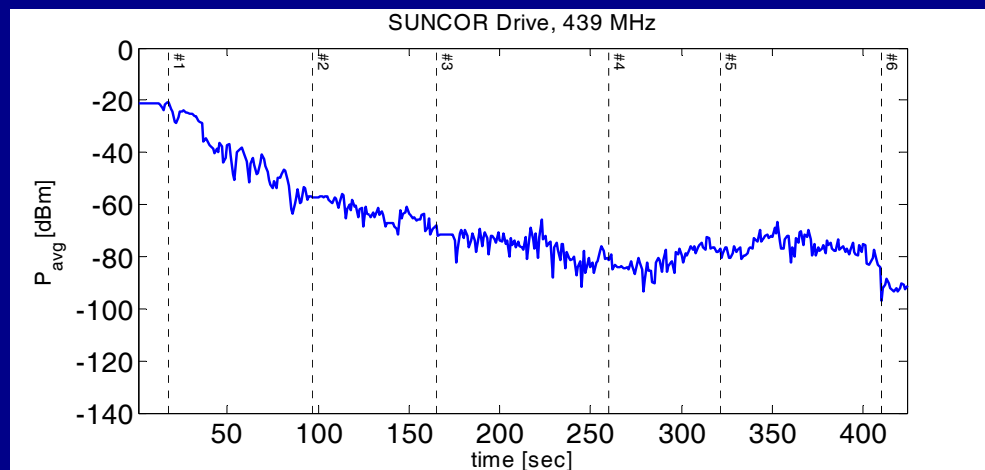

439 MHz

Synthetic pulse and modulated-signal

Test point locations

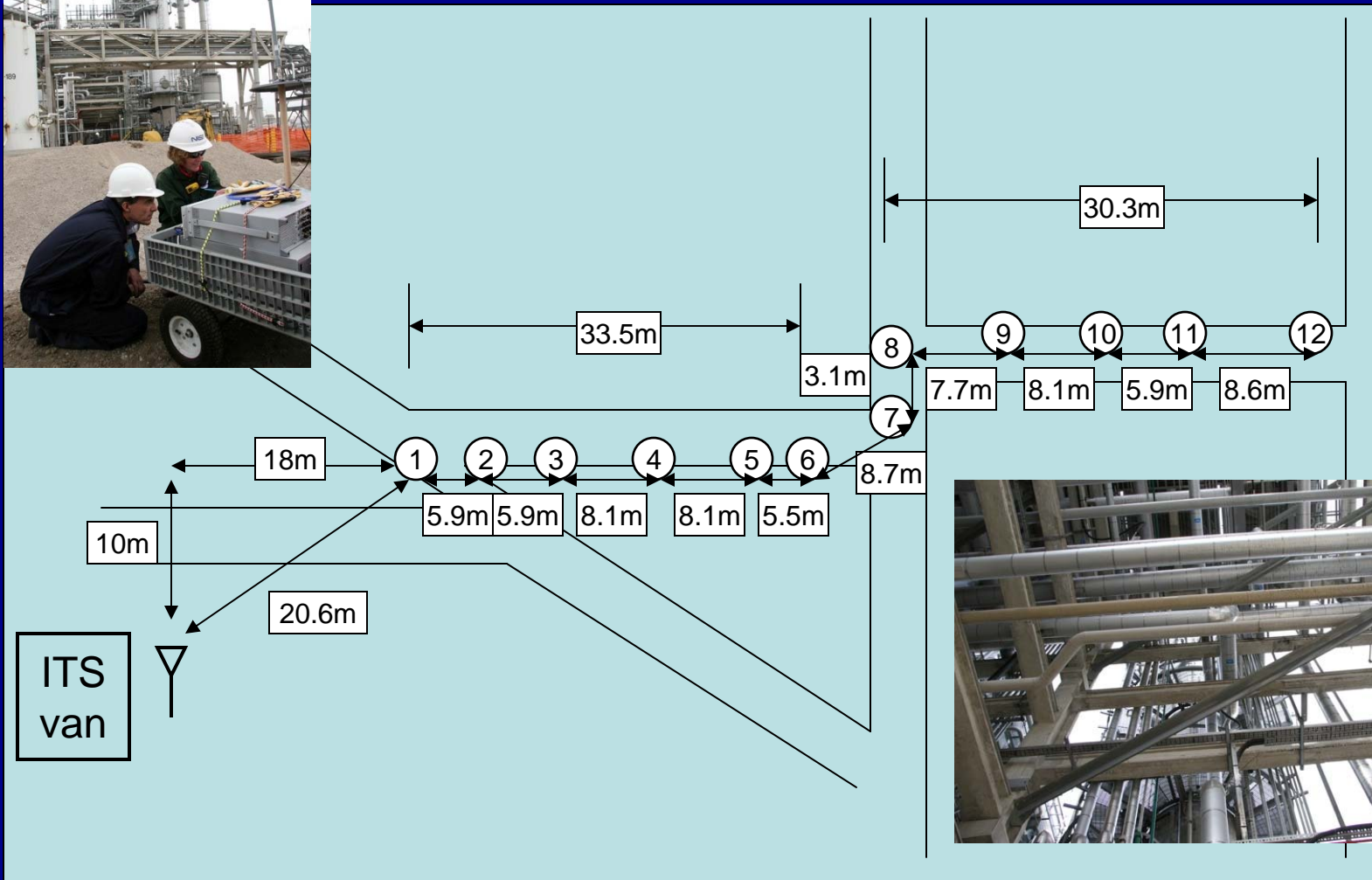

UWB synthetic-pulse measurement system

- Collect data over wide frequency band
- Fourier transform to time domain
- Synchronize using optical fiber
- Good for wideband characteristics, RMS delay spread

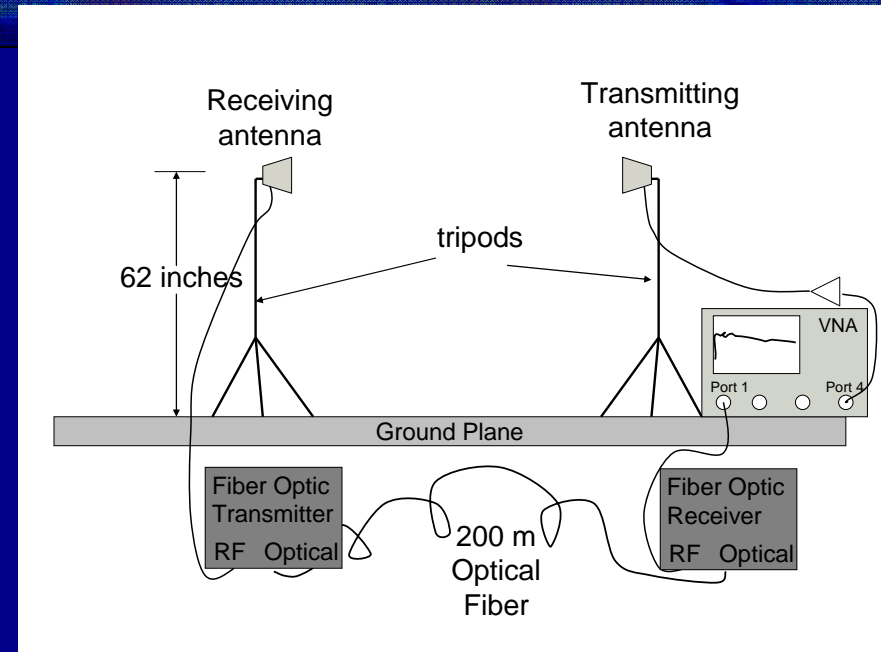

Frequency domain response

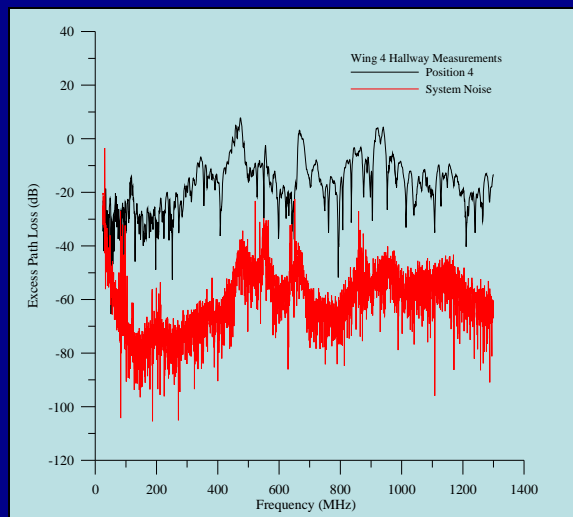

Time-domain waveform

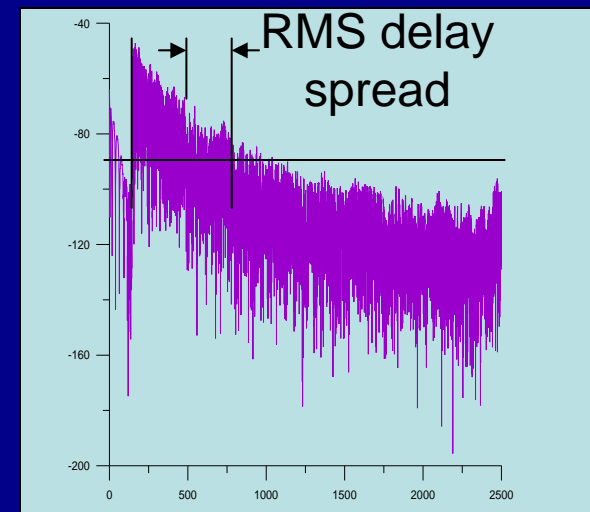

UWB synthetic pulse

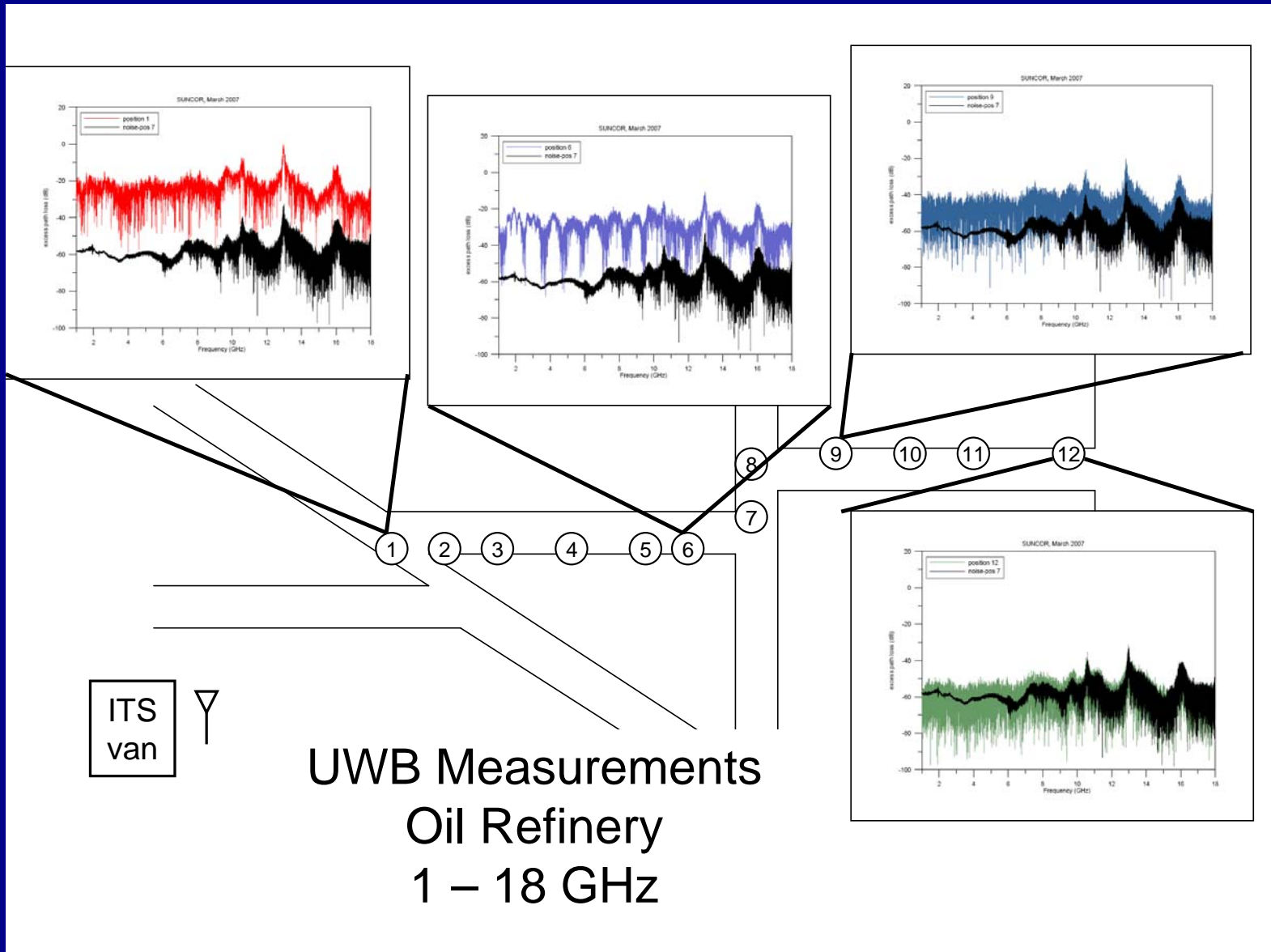

UWB synthetic pulse

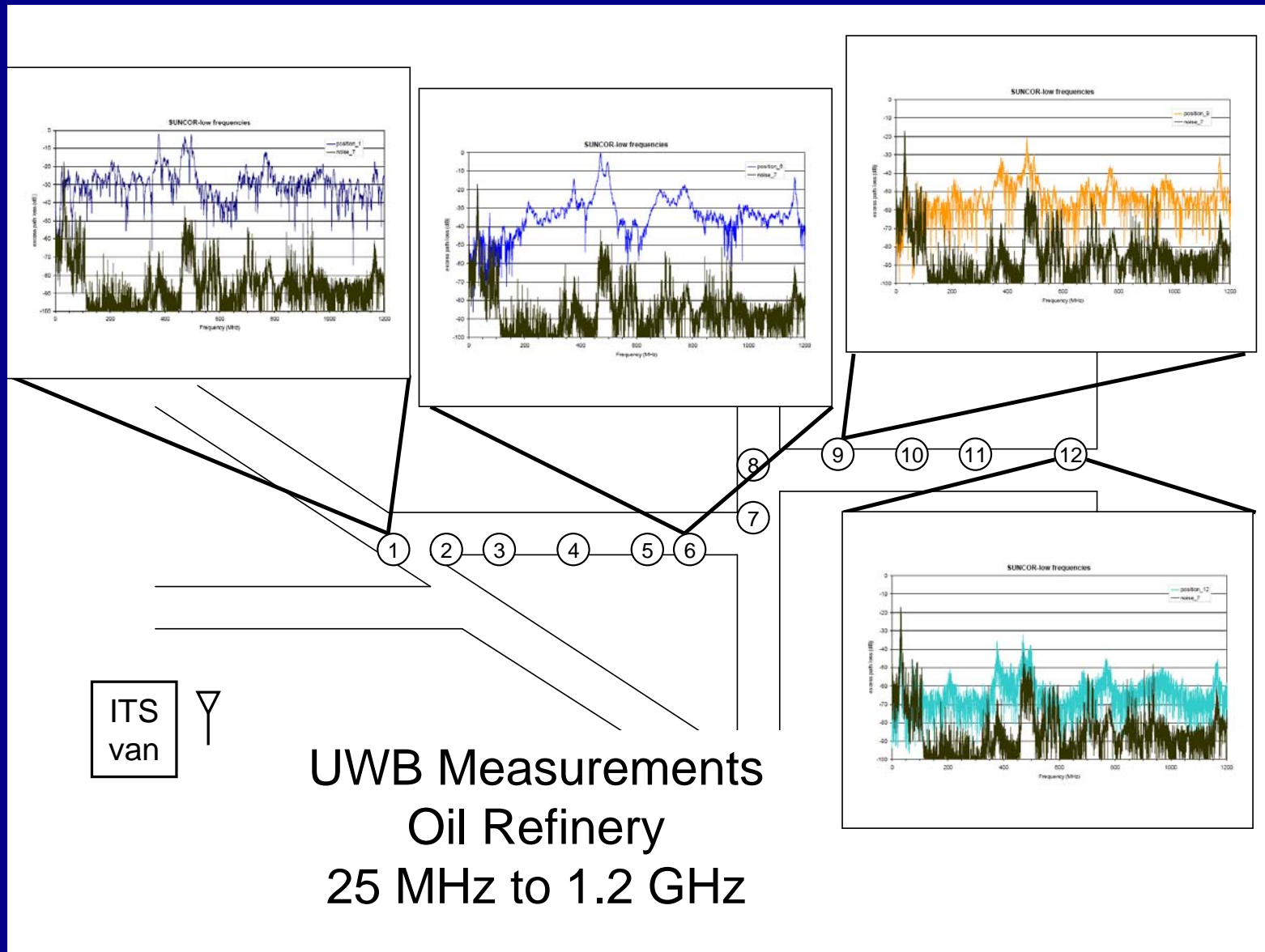

UWB synthetic pulse

SUNCOR facility (3/9/07)

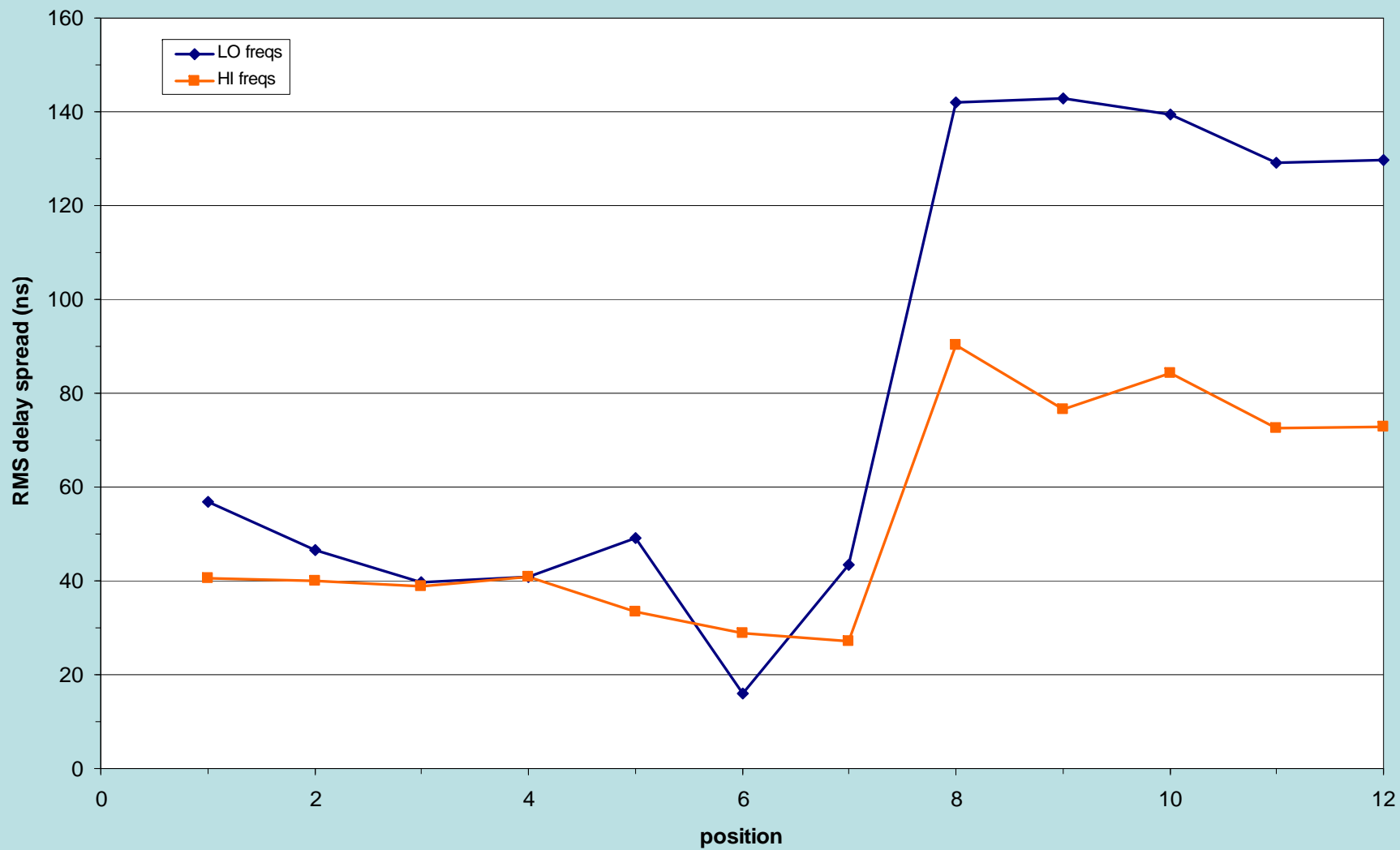

Digitally modulated signal measurements

Vector signal analyzer (VSA)

- Signal generator creates digital signals
- Detailed measurement around carrier (4.95 GHz, etc.)
- Good for characterization of realistic wideband digital signals

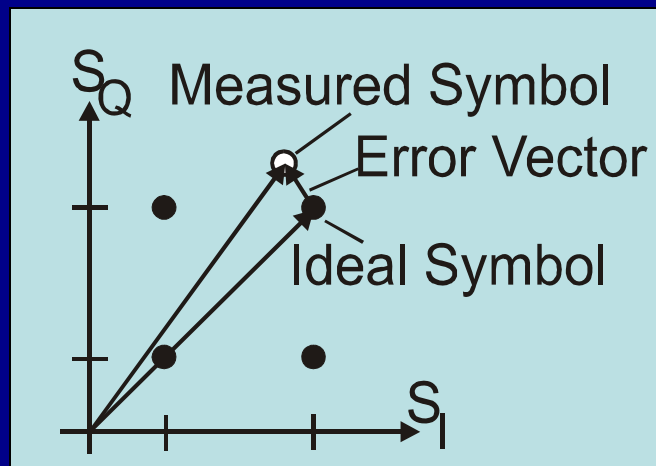
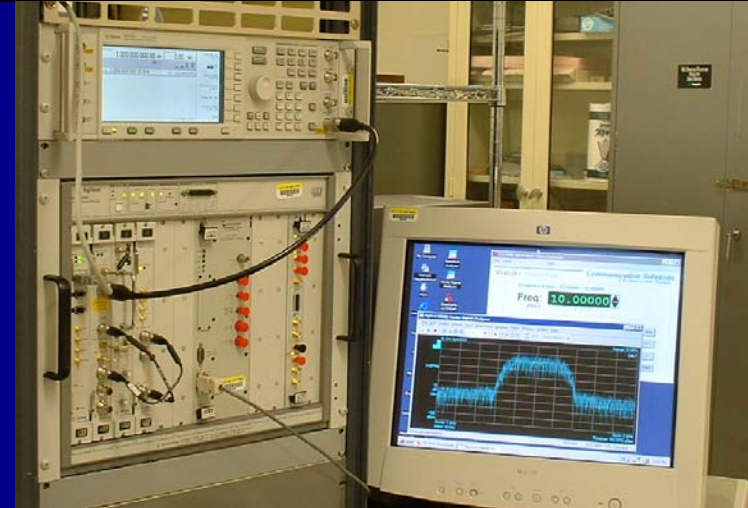

Error Vector Magnitude (EVM)

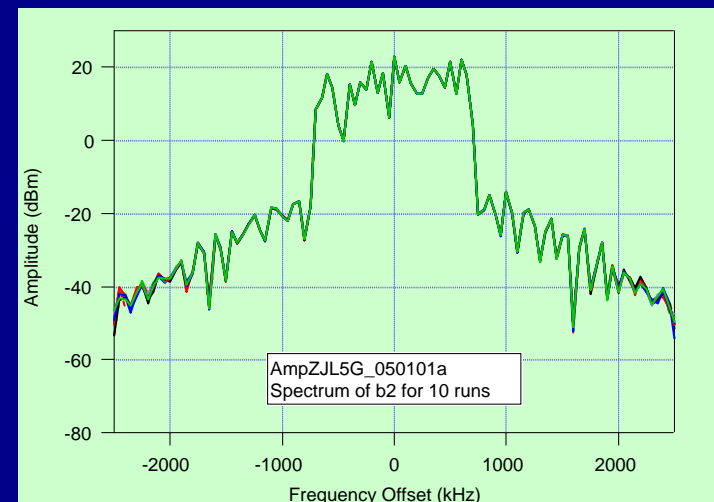

Adjacent channel power ratio (ACPR)

QPSK, OFDM digitally modulated signal

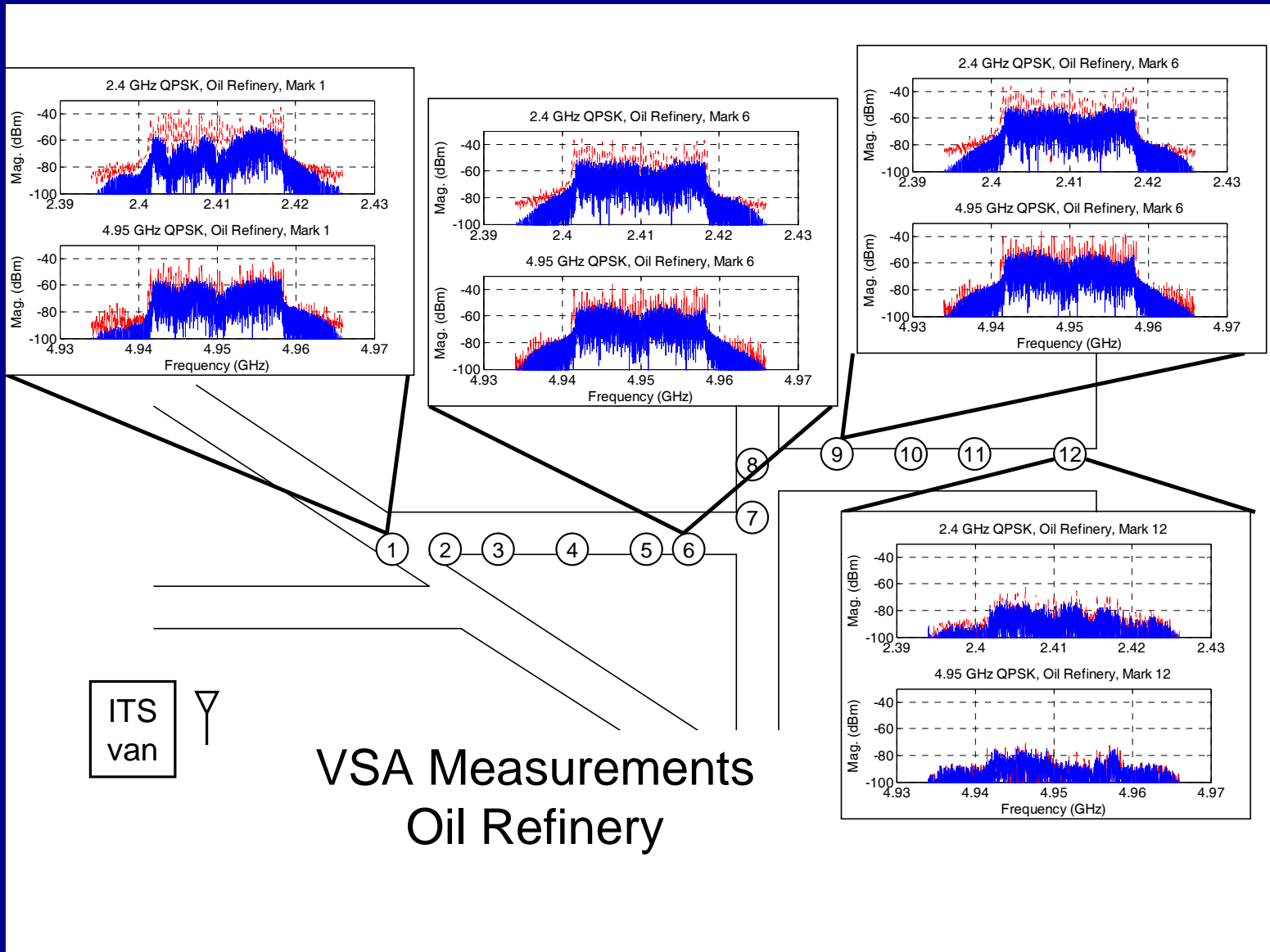

Comparison of modulation, frequency

EVM for QPSK and 64QAM modulation at 2.44 GHz and 4.95 GHz

Key:

2.44 GHz QPSK
2.44 GHz 64QAM
4.95 GHz QPSK
4.95 GHz 64QAM

1	2	3	4	5	6
3.6	7.9	4.1	1.7	5.3	3.2
4.3	5.5	4.7	1.7	5.5	2.3
4.2	5.6	3.2	3.6	6.6	3.0
3.5	5.4	3.2	3.1	5.7	2.5

7	8	9	10	11	12
2.6	17.3	18.2	--	--	--
1.8	14.3	13.4	--	--	--
3.9	--	--	--	--	--
3.0	--	--	--	--	--

ITS van



~60m

~75m

4.95 GHz signal

2.44 GHz signal

① ② ③ ④ ⑤ ⑥

⑧ ⑨ ⑩ ⑪ ⑫
⑦

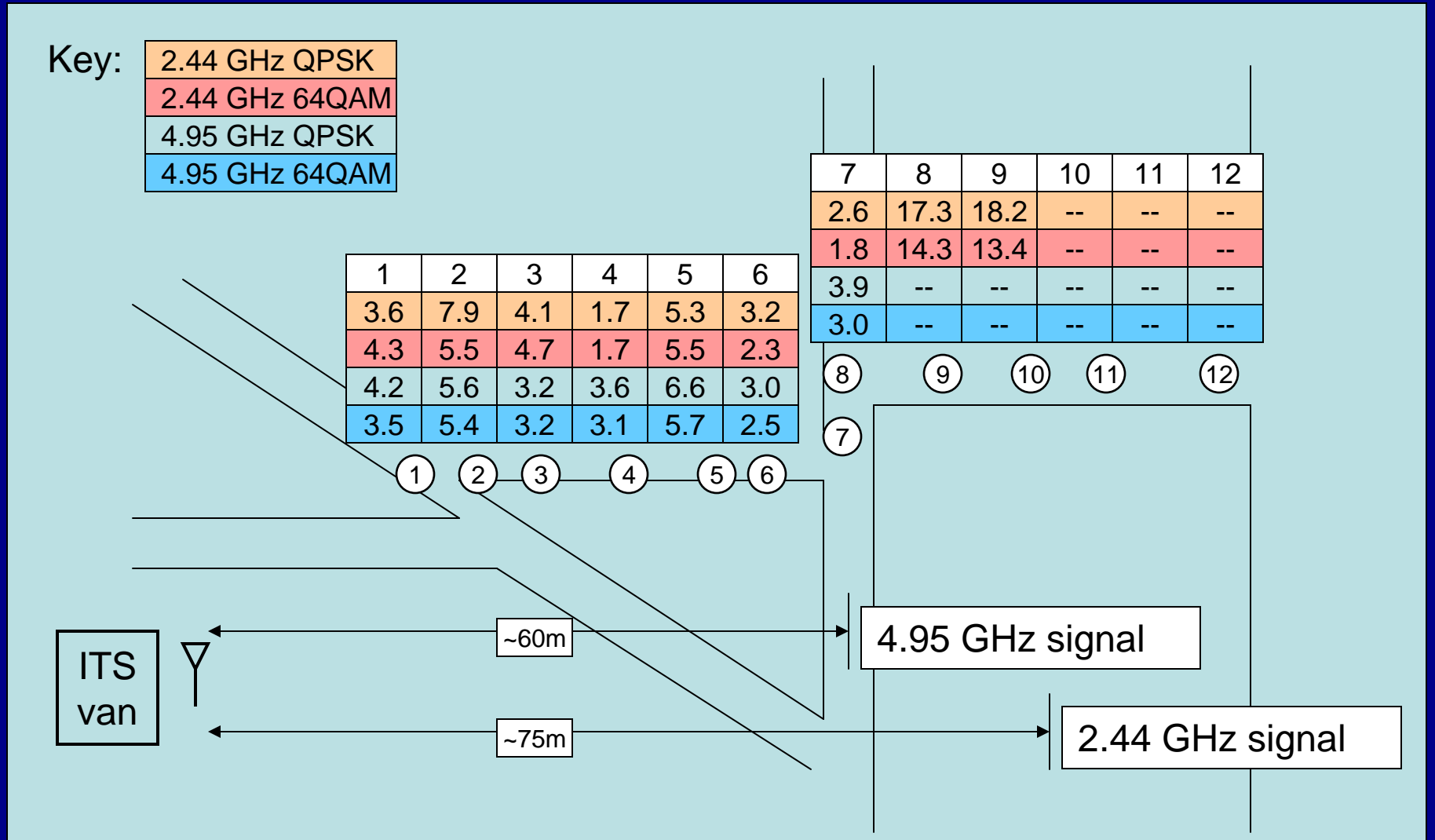

Reverberation chamber tests

Simulate high multipath environments:

- Repeatable
- Error analysis
- Inexpensive, efficient test facility

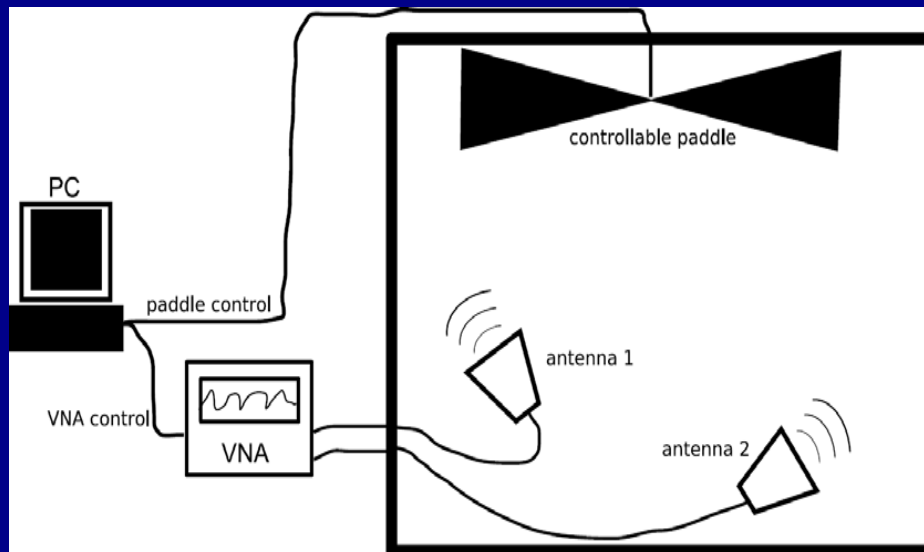
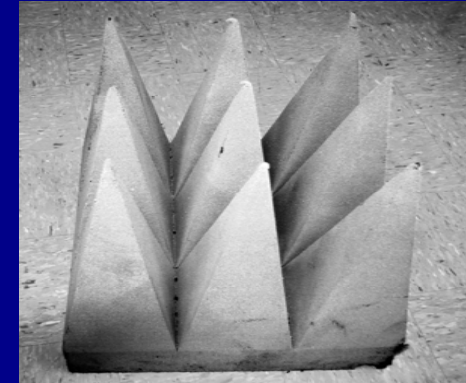

Reverberation Chamber Tests

- Compare time-domain statistics oil refinery (power delay profile, RMS delay spread) to those in the chamber.
- Duration of reflections can be bounded by reverb chamber.

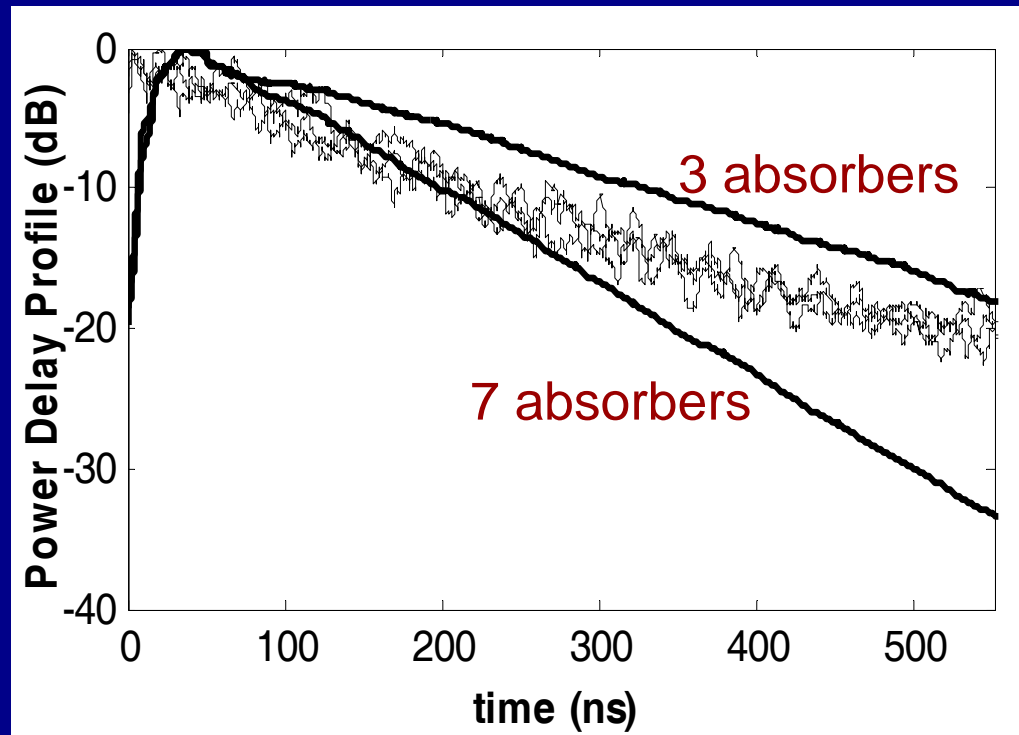

Oil refinery data at one location

Wireless in high multipath locations

- Large body of data in oil refinery:
 - single-frequency
 - wideband, synthetic pulse
 - wideband digitally modulated signal
- Measurements show:
 - Non-line-of-sight, high multipath conditions even though outdoors
 - Low frequencies can experience waveguide-below-cutoff effect
 - 4.95 GHz band fails sooner than 2.4 GHz band
- Reverberation chamber:
 - simulate high multipath environment
 - useful for device qualification

Calibrated Receiver for Weak Signal Detection

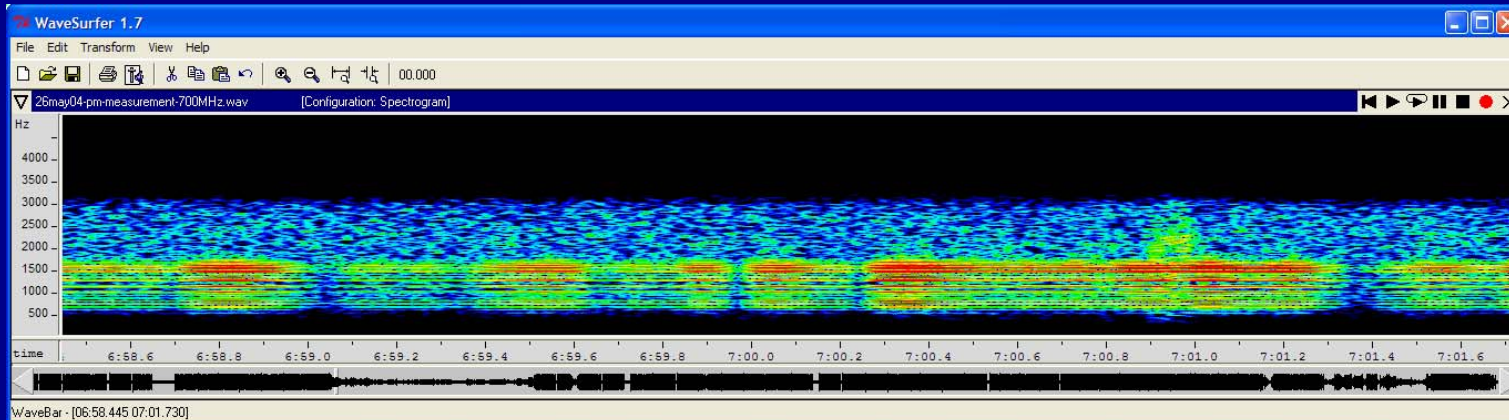

raw
data

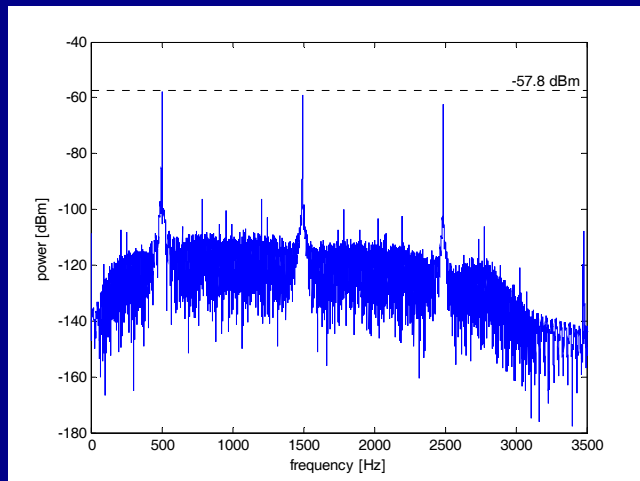

processed spectrum

Narrowband receivers
detect signals orders of
magnitude weaker than
standard equipment