



Broadband Spectrum Survey Measurements: Approaches and Results

For the International Symposium on Advanced Radio
Technologies (ISART), Boulder, CO
June 2, 2008

Frank Sanders, NTIA/ITS
Chief, Telecommunications Theory Division, NTIA/ITS.T
fsanders@its.bldrdoc.gov
303.497.7600



NTIA RSMS

- Radio Spectrum Measurement System (RSMS): Vehicle-deployed, computer-controlled, 30 MHz -18 GHz. Wide range of measurement and processing capabilities.
- 3-4 full-height equipment racks, 2 telescoping masts (9 m height), RF-shielded compartment, on-board power generator, air conditioning, storage cabinets.
- Nominal 10 dB noise figure for most measurements

Spectrum and system compatibility studies

Band occupancy and crowding: LMR, radars

Interference resolution studies

Data base verification

→ Site surveys and broadband spectrum surveys



Example: RSMS-3

Self-contained measurement van.
Two computer-controlled systems.
Remote monitoring by phone or
cell-phone.

Typical site surveys or spectrum
usage measurements
100 MHz -18 GHz.

Shown set up for “stand-off”
spectrum usage measurements in
the Los Angeles, CA area

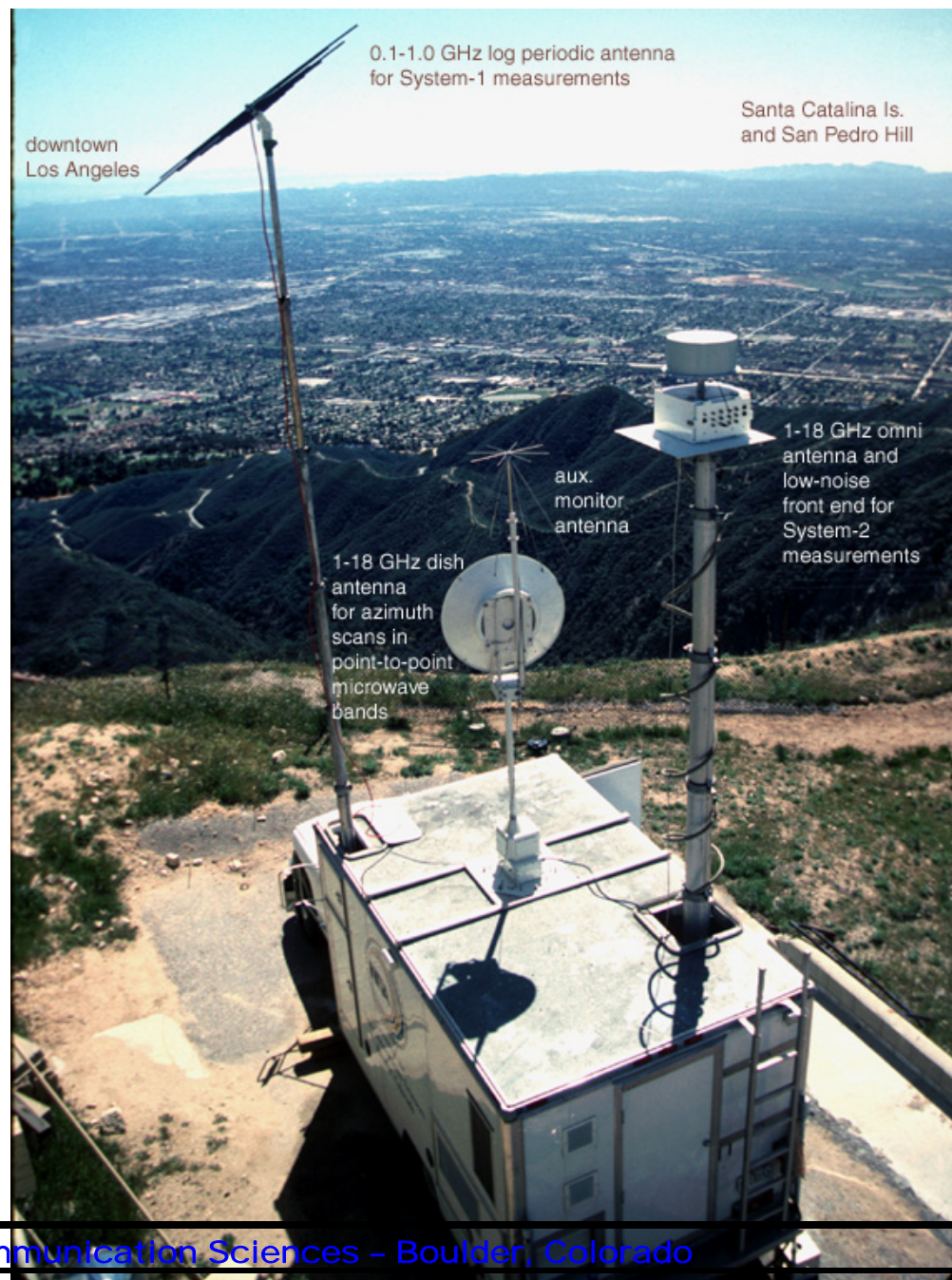



RSMS Hardware

System 1 - 0-1 GHz
 Small tower, YIG and varactor preselectors.

System 2 - 1-18 GHz
 Large tower, tower-top YIG & bandpass filters/preamps.

Computer control, GPS, noise diode calibration at antennas, radar pulse analyzer, digital oscilloscope, etc.

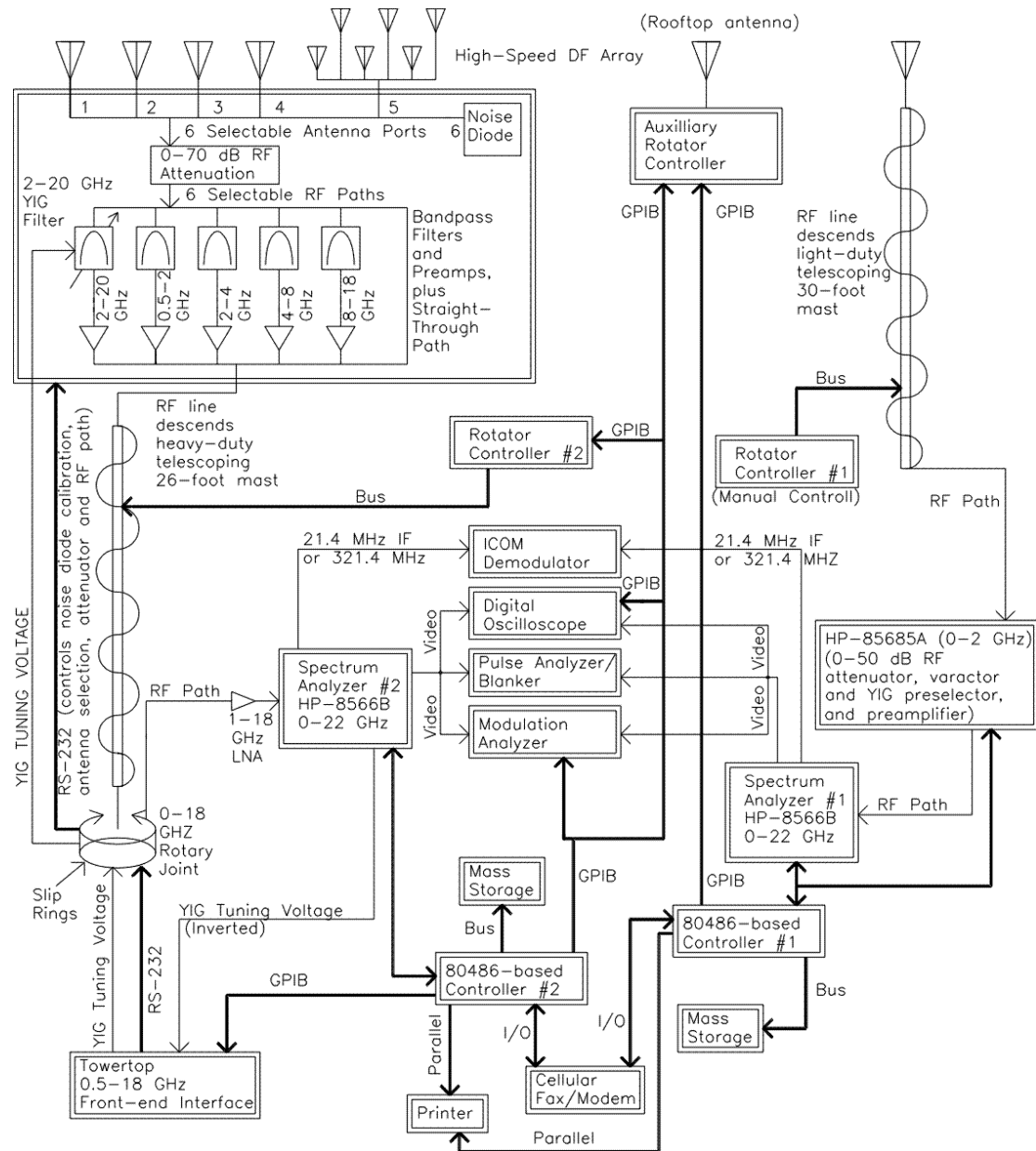



RSMS Hardware

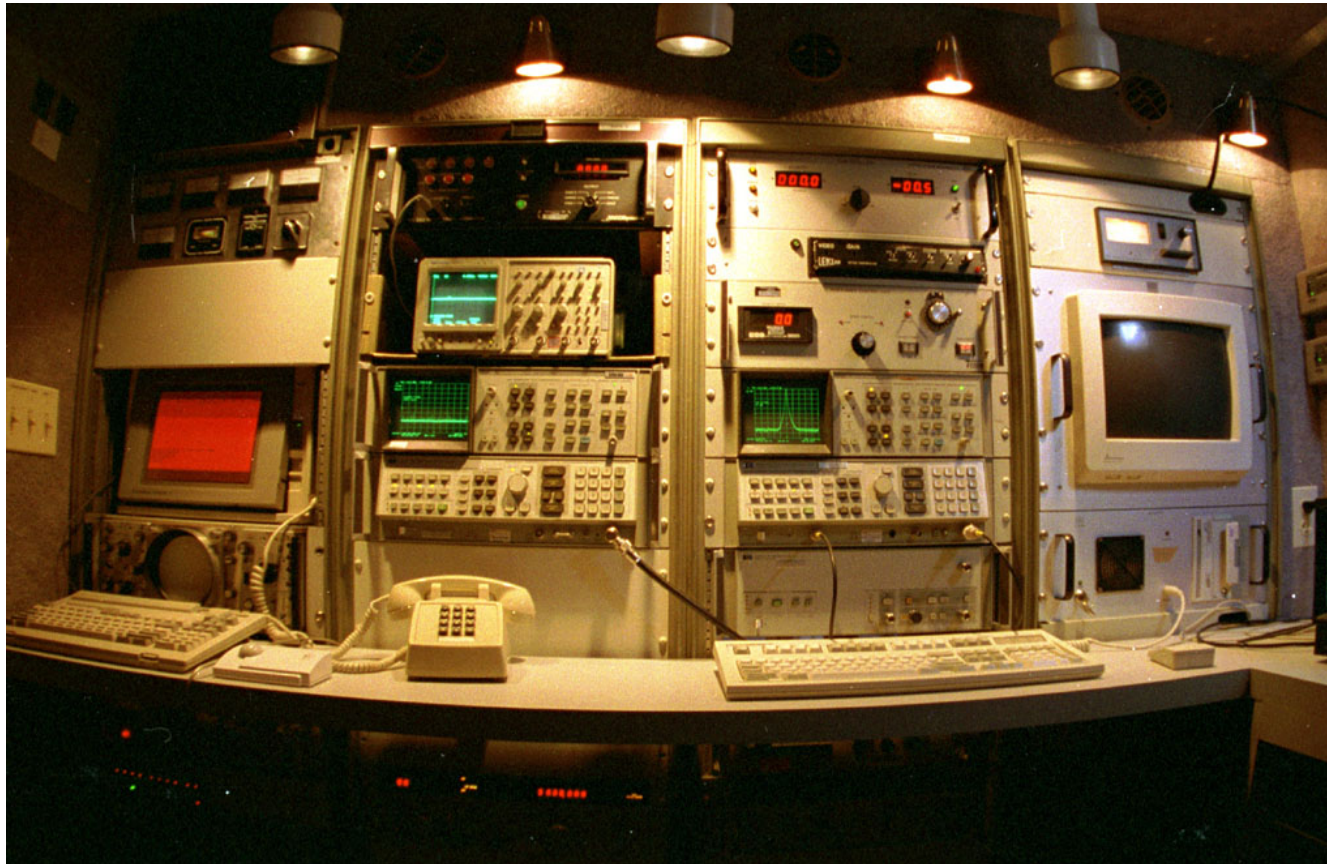

Interior Equipment Bay of NTIA RSMS-3

[Institute for Telecommunication Sciences - Boulder, Colorado](#)



Swept-Frequency Measurements for Mobile Radio Bands

- Basic strategy is to *sweep* (in time) across a frequency range
- Most basic of all spectrum analyzer modes
- Limited dynamic range (only about 60 dB, depending upon spectrum analyzer characteristics)
- Often useful for a quick look at spectrum use
- Useful for monitoring amplitudes and observing modulation envelopes of high duty-cycle signals, such as LMR, digital radios, and point-to-point microwave links



Stepped-Frequency Measurements for Radars

- Basic strategy is to *step* (in a series of zero-hertz time slices) across a frequency range
- Sophisticated mode requiring computer control of spectrum analyzer
- Dynamic range of about 60 dB (spectrum analyzer) plus 70 dB (front-end attenuator) for a total of 130 dB maximum dynamic range
- Critical for measuring radar emissions, plus miscellaneous applications to other transmitters



Extended Dynamic Range with the Stepped Mode

- Critical for measuring many types of emission spectra for spectrum management purposes
- Unique NTIA capability that few (if any) other organizations possess



Azimuth Scans for Point-to-Point Microwave Bands

- Used to measure occupancy in fixed point-to-point microwave bands
- A parabolic dish antenna is slowly rotated around the horizon while a spectrum analyzer is swept rapidly across a defined frequency range; sweep speed is fast enough to cover entire spectrum band within a single beamwidth of the scanning dish
- With the spectrum analyzer in a maximum-hold, positive peak detector mode, the envelope of point-to-point occupancy is developed. The effect is to have an omnidirectional antenna pattern with the gain of a dish



Broadband Spectrum Surveys

- 0.1–19.6 GHz spectrum occupancy measurements from high sites near four major metropolitan areas. At: www.its.bldrdoc.gov

Denver, Colorado	NTIA Report 95-321
San Diego, California	NTIA Report 97-334
Los Angeles, California	NTIA Report 97-336
San Francisco, California	NTIA Report 99-367
- General spectrum usage patterns in each band. Measurement algorithms selected to match specific services in each band. Bandwidth, antenna, sampling intervals and totals, detector type, post-measurement analysis.
- Not broadband noise data. Algorithms optimized for signal interception in each band. Possible new algorithms to give noise APDs at selected no-signal frequencies.



Uses of Spectrum Data

A. Which bands are heavily used? Useful for seeing:

Continuous, strong, overlapping signals (LMR, broadcasting, radars);
Changes and trends in band usage for spectrum management policy;
Observing non-licensed/ISM services where no data base info available.
Some services “invisible” to RSMS algorithms (satellite, radio astronomy).

B. What frequencies are available for noise measurements?

Helps to find quiet frequencies, not occupied by intentional emissions.

C. Tell us if minimum levels are determined by signals, external noise, or kTB.

External noise < kTB. No problem. Not practical to measure

External noise > kTB. Problem for licensed systems. Measure it.

External noise = kTB. Problem and hard to measure.



Spectrum Survey Logistics

- Survey data are usually measured at a site for two weeks. Measurements run 24 hours/day under computer control. More dynamic bands are measured more frequently than others (such as broadcast bands).
- 0.1-1 GHz measurements have used use a log periodic or omnidirectional antenna, using about 17 different measurement “events” combined in a 36-event schedule, requiring 5.5 hours to complete.
- 0.5-19.6 GHz measurements have used use a slant-polarized biconical antenna, using about 17 different measurement “events” combined in a 30-event schedule, requiring 12 hours to complete.
- Calibrations, maintenance and occasional signal overload tests are performed regularly during measurements.



108-138 MHz band

VHF OmniRange-VOR

Air Traffic Control (ATC)

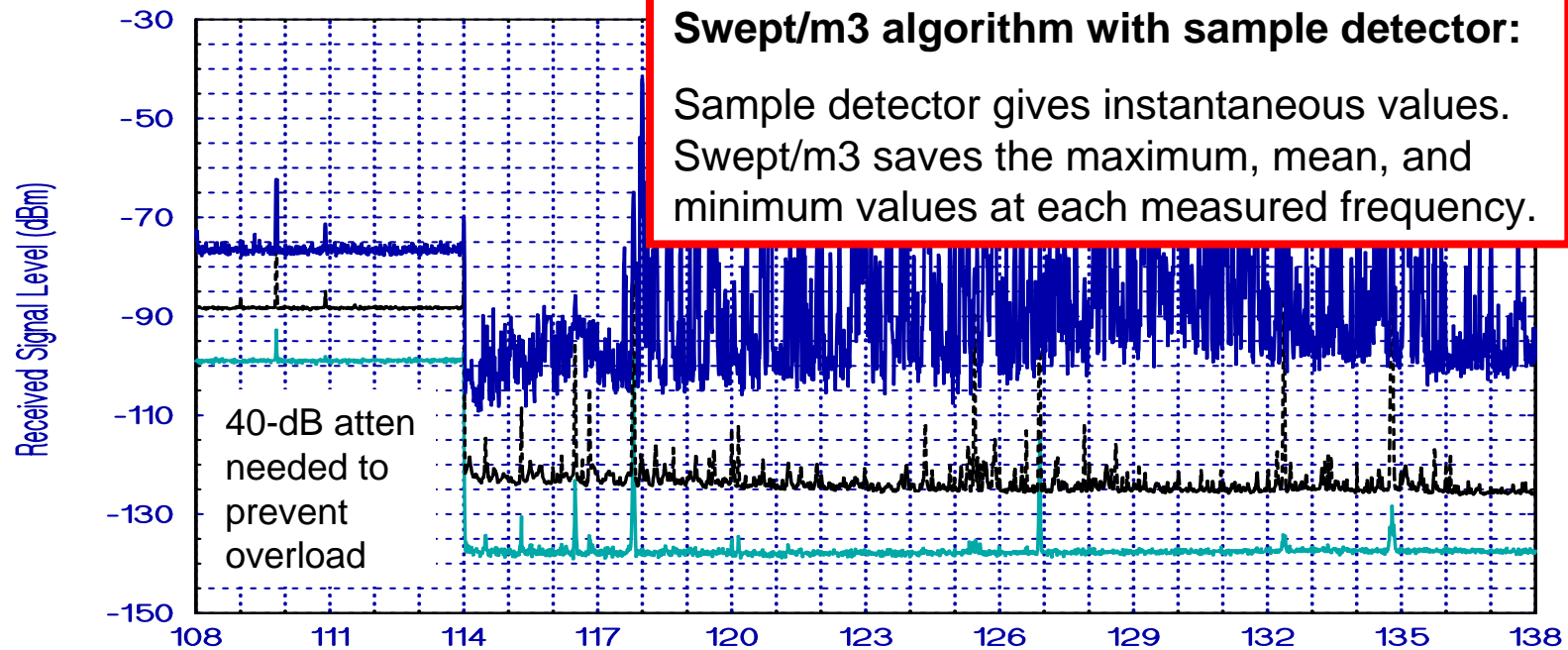

7,000 sweeps across the 108-138 MHz range at San Diego, CA, 1995.
Band event 11, swept/m3 algorithm, sample detector, 10-kHz bandwidth



138-162 MHz band

Military LMR

amateur

Mil LMR

Commercial Land Mobile Radio

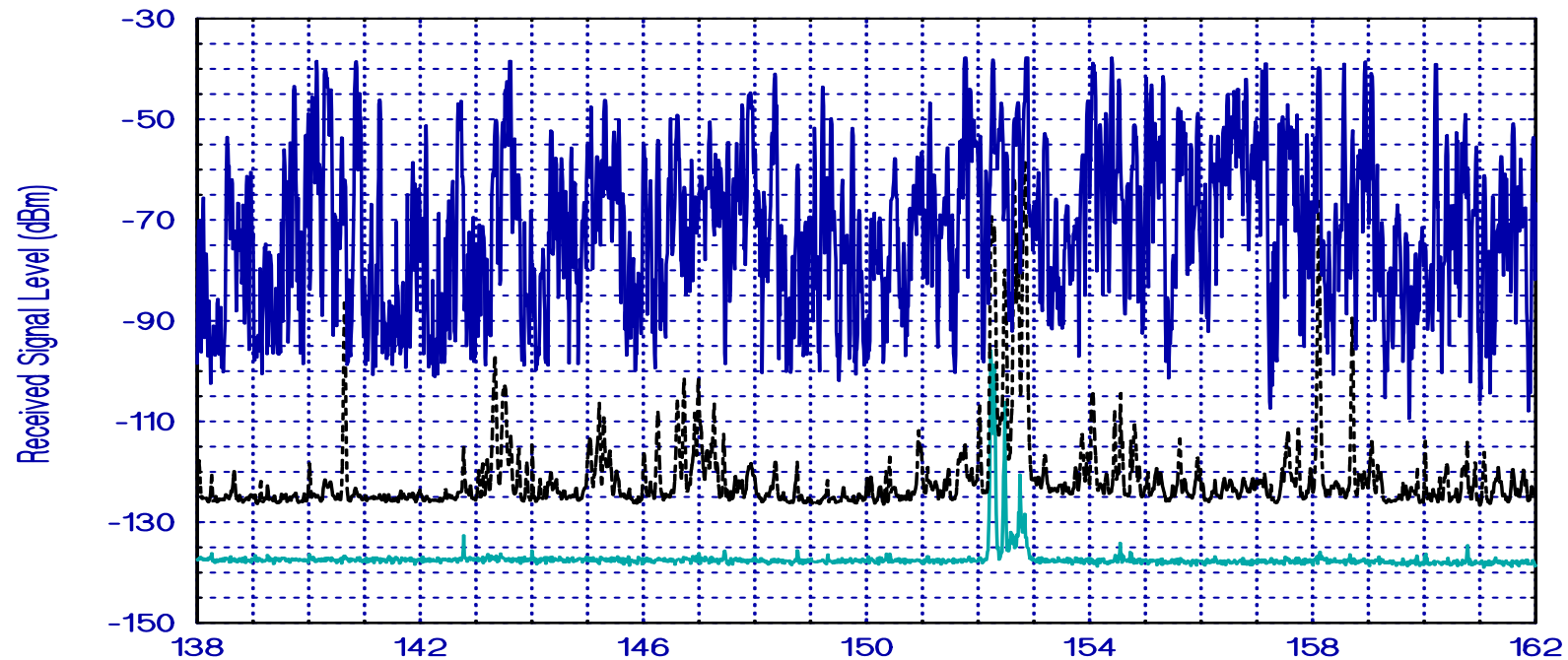

7,000 sweeps across the 138-162 MHz range at San Diego, CA, 1995.
Band event 11, swept/m3, sample detector, 10-kHz bandwidth.



162-174 MHz band

Federal Land Mobile Radio (LMR)

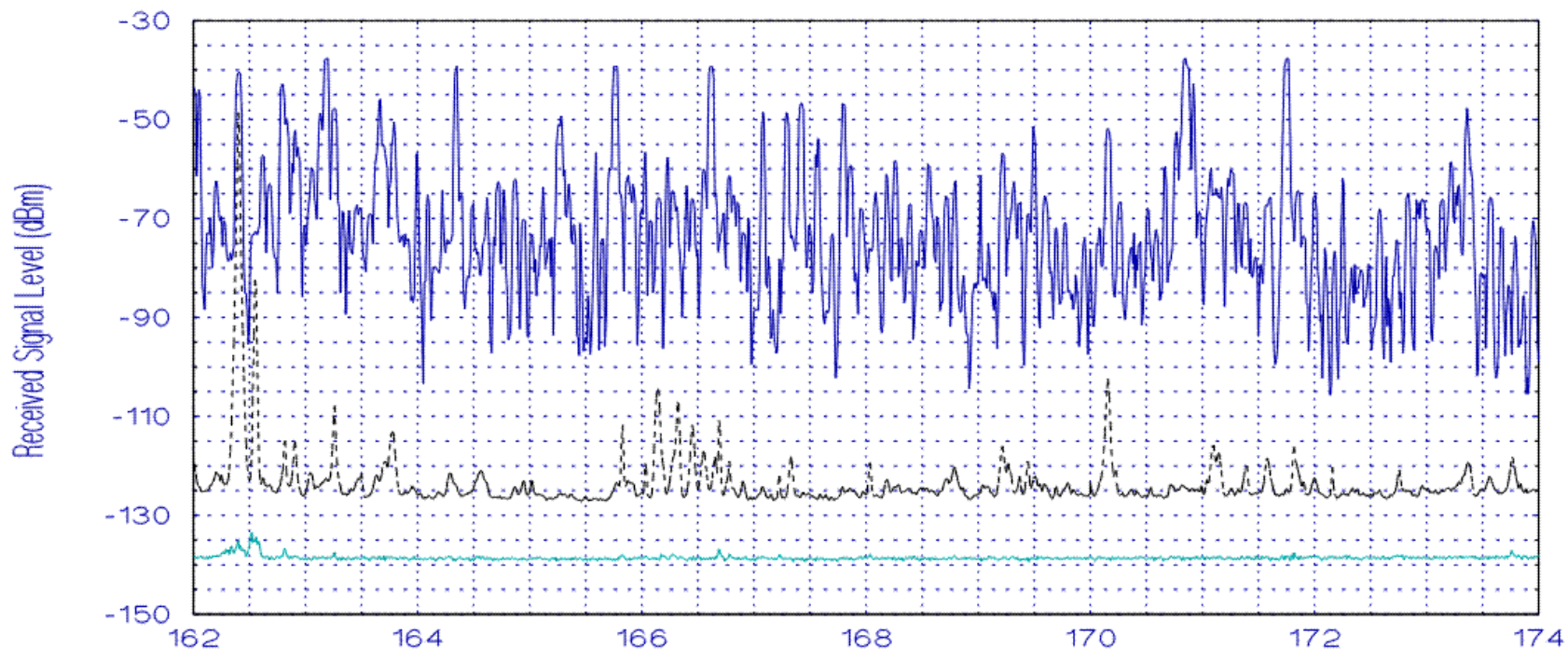

52,500 sweeps across the 162-174 MHz range at San Diego, CA, 1995.
Band Event 12, swept/m3 algorithm, sample detector, 10-kHz bandwidth



174-216 MHz band

VHF television broadcasting

Chan 7 Chan 8 Chan 9 Chan10 Chan 11 Chan 12 Chan 13

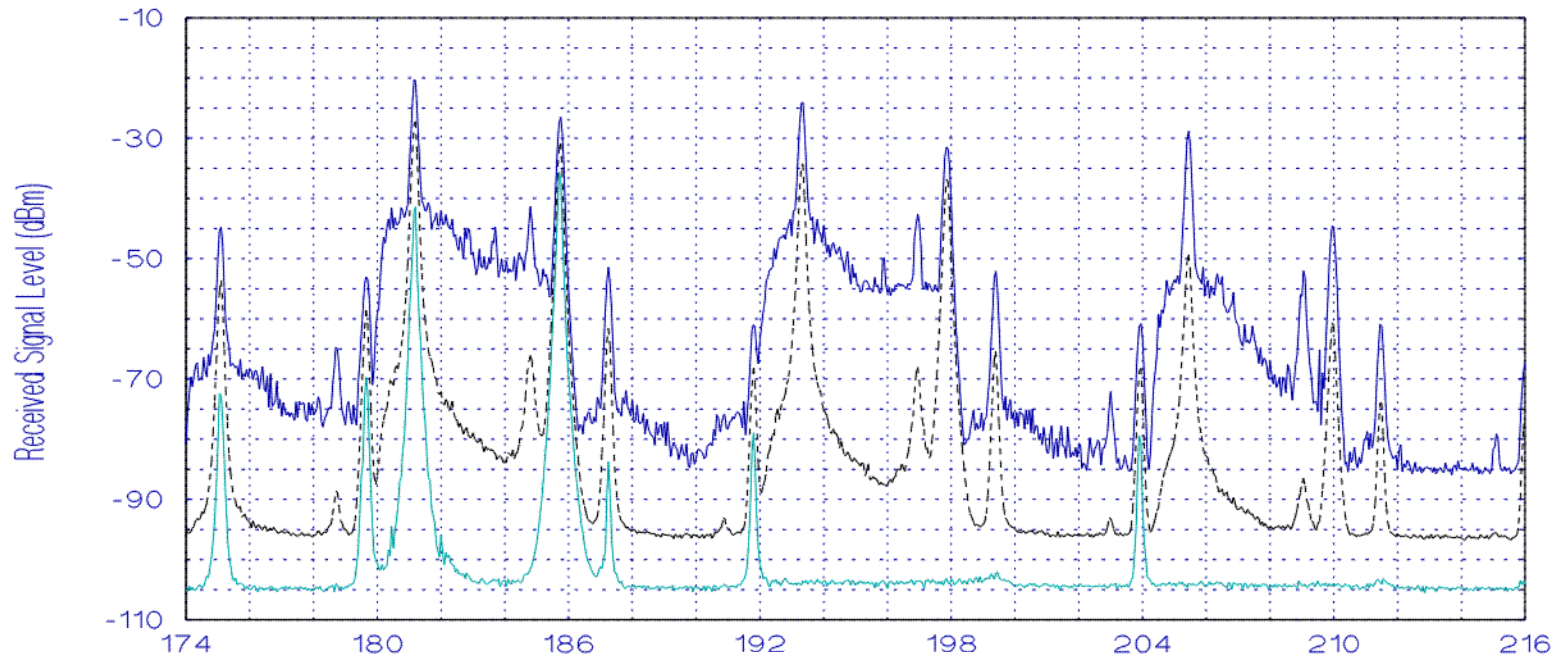

18,500 sweeps across the 174-216 MHz range at San Diego, CA, 1995.
Band event 13, swept/m3 algorithm, sample detector, 100-kHz bandwidth



216-225 MHz band

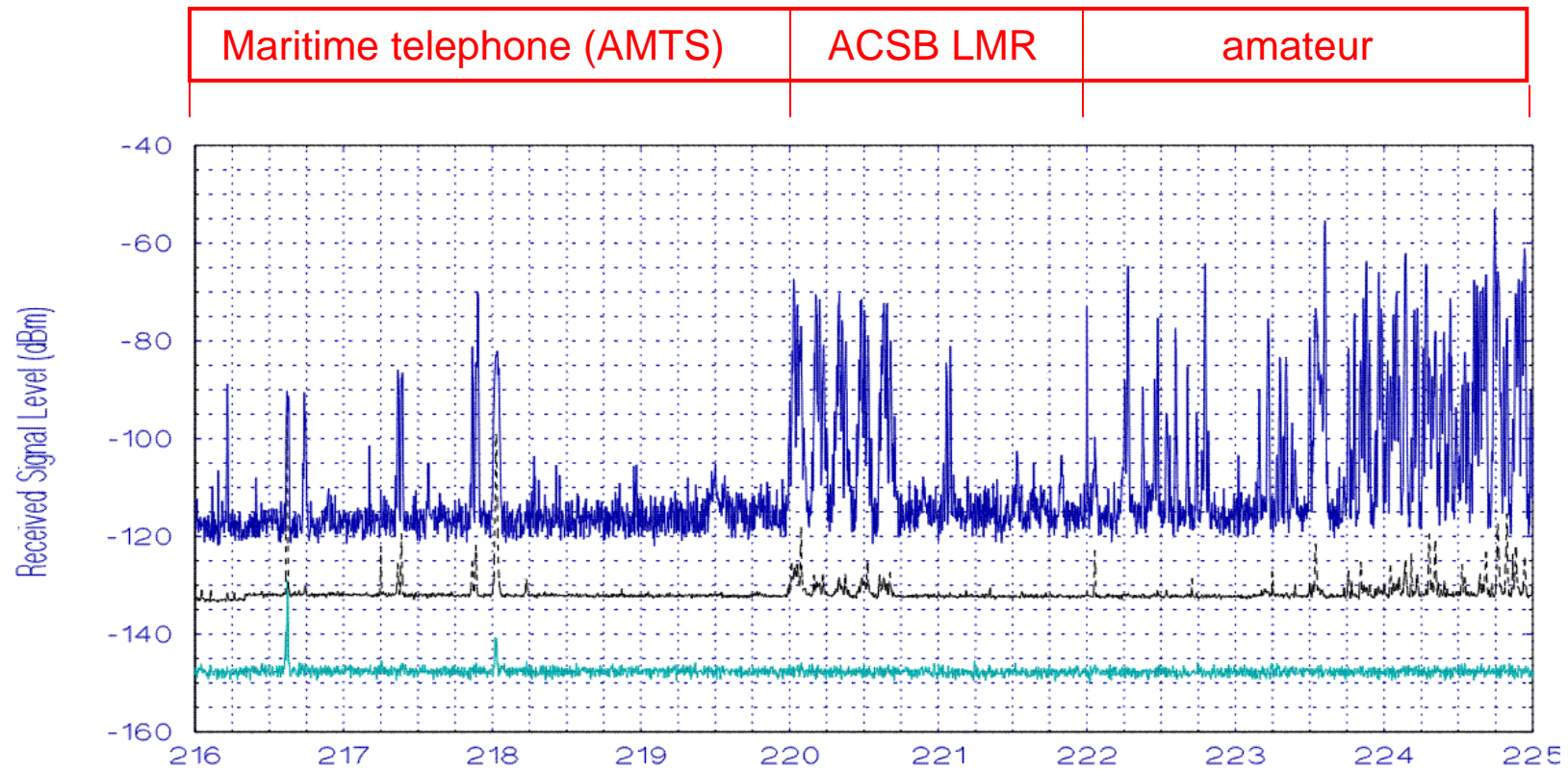

4,020 sweeps across the 216-225 MHz range at San Diego, CA, 1995.
Band event 14, swept/m3 algorithm, sample detector, 3-kHz bandwidth



225-400 MHz band

Military ATC and tactical communications

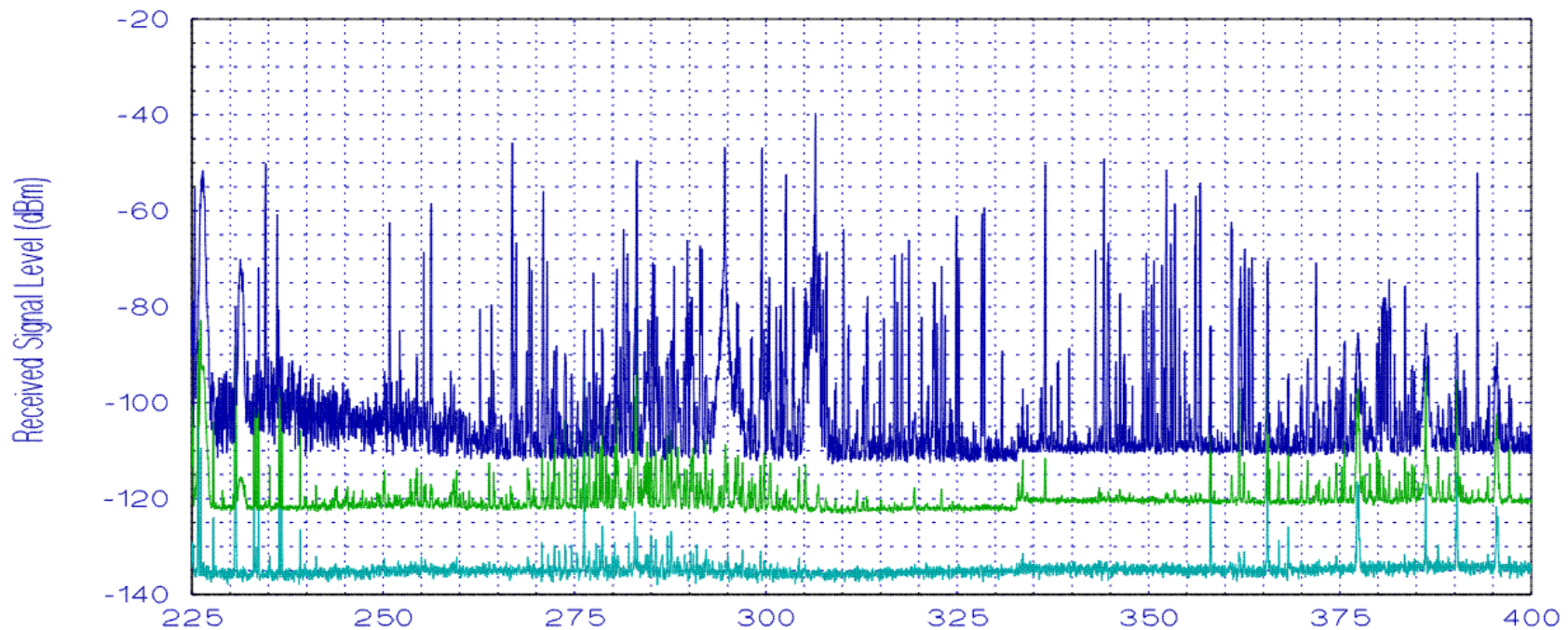

2,900 sweeps across the 225-400 MHz range at San Diego, CA, 1995.
Band event 15, swept/m3 algorithm, sample detector, 30-kHz bandwidth



400-406 MHz band

Meteorological satellites and radiosondes

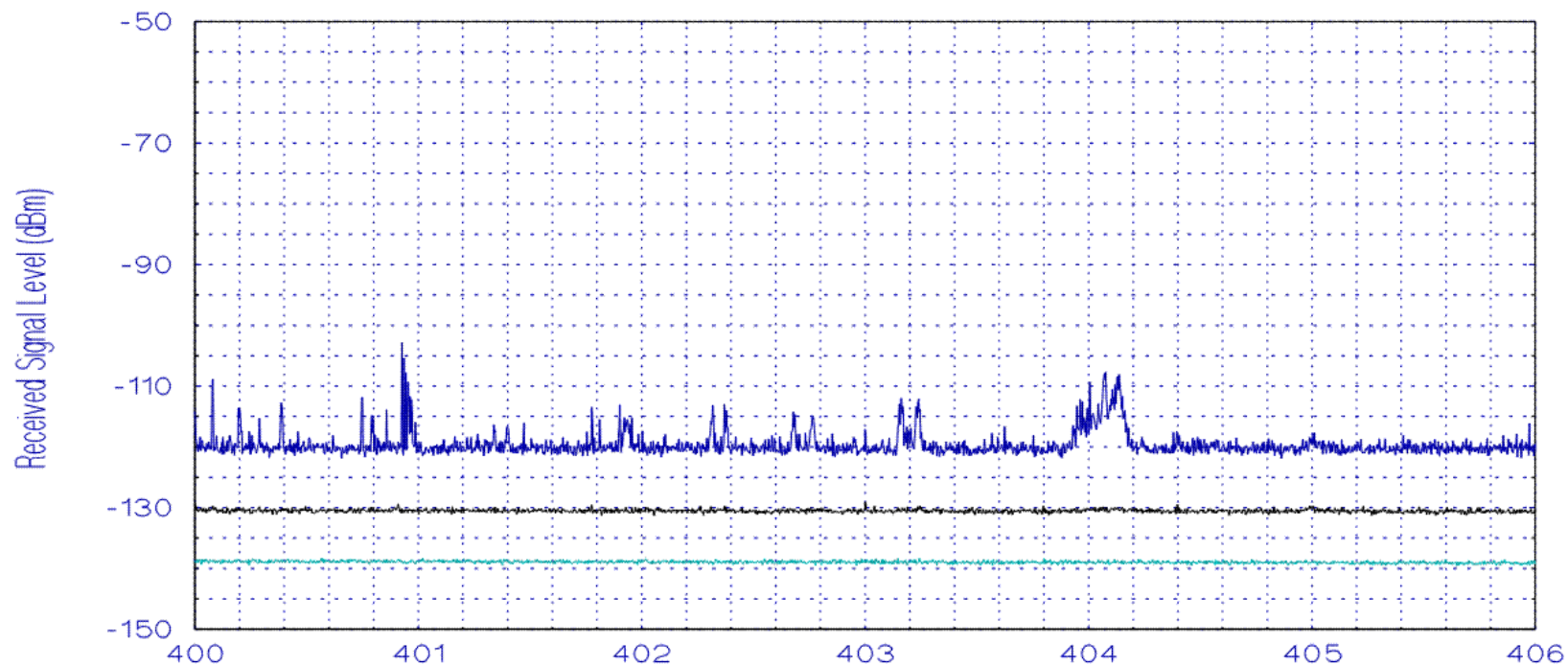

2,040 sweeps across the 400-406 MHz range at San Diego, CA, 1995.
Band event 16, swept/m3 algorithm, sample detector, 3-kHz bandwidth



406-420 MHz band

Federal (non-military) fixed and mobile

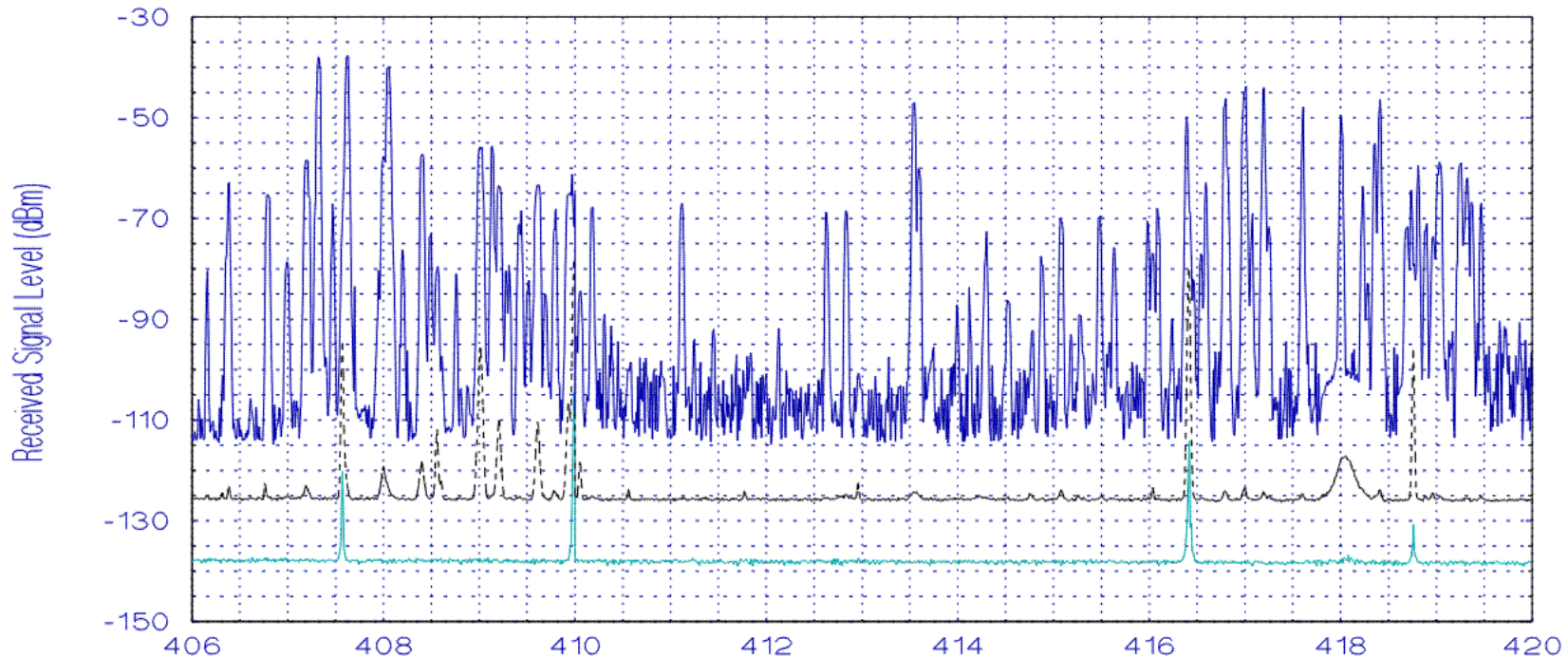

20,600 sweeps across the 406-420 MHz range at San Diego, CA, 1995.
Band event 17, swept/m3 algorithm, sample detector, 10-kHz bandwidth



420-450 MHz band

military long-range radars and amateur radio

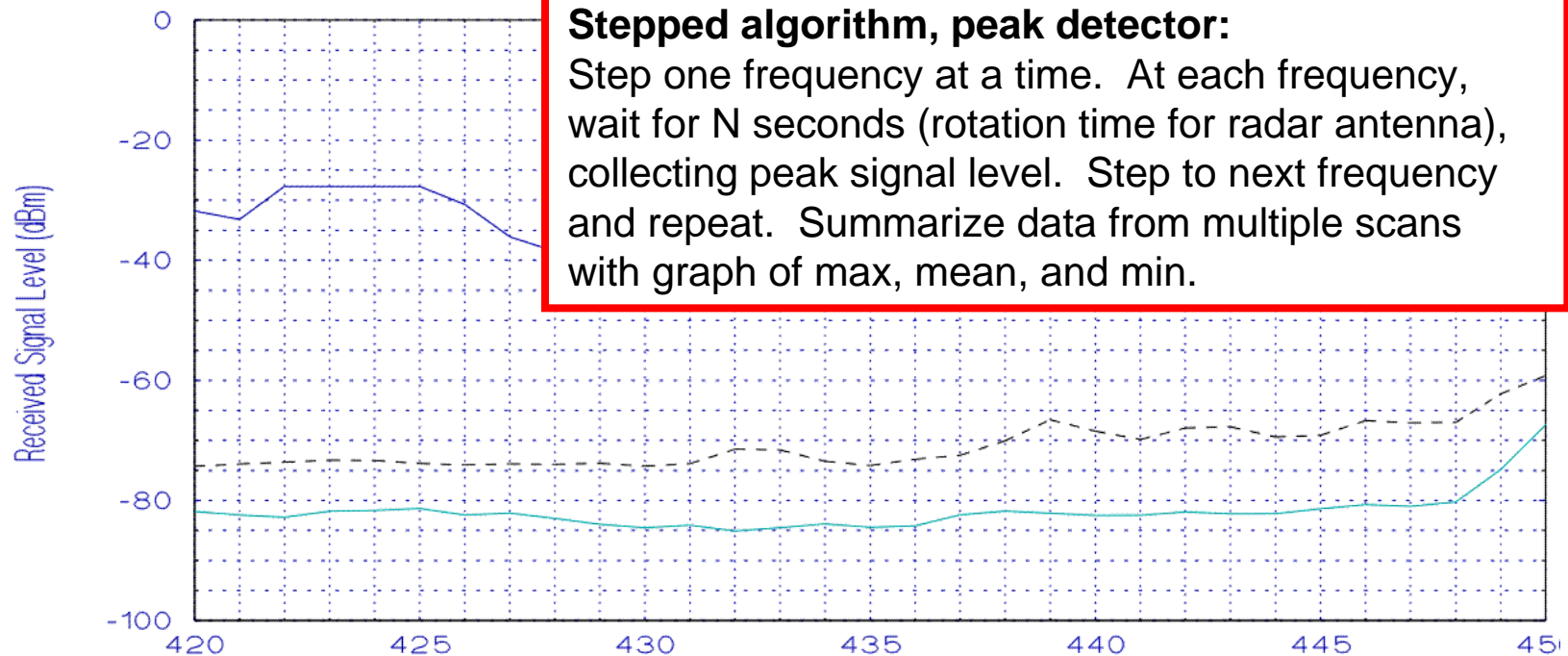

68 scans across the 420-450 MHz range at San Diego, CA, 1995.
Band event 18, stepped algorithm, +peak detector, 1000-kHz bandwidth



450-470 MHz band

commercial land mobile radio			
base	mobile	base	mobile

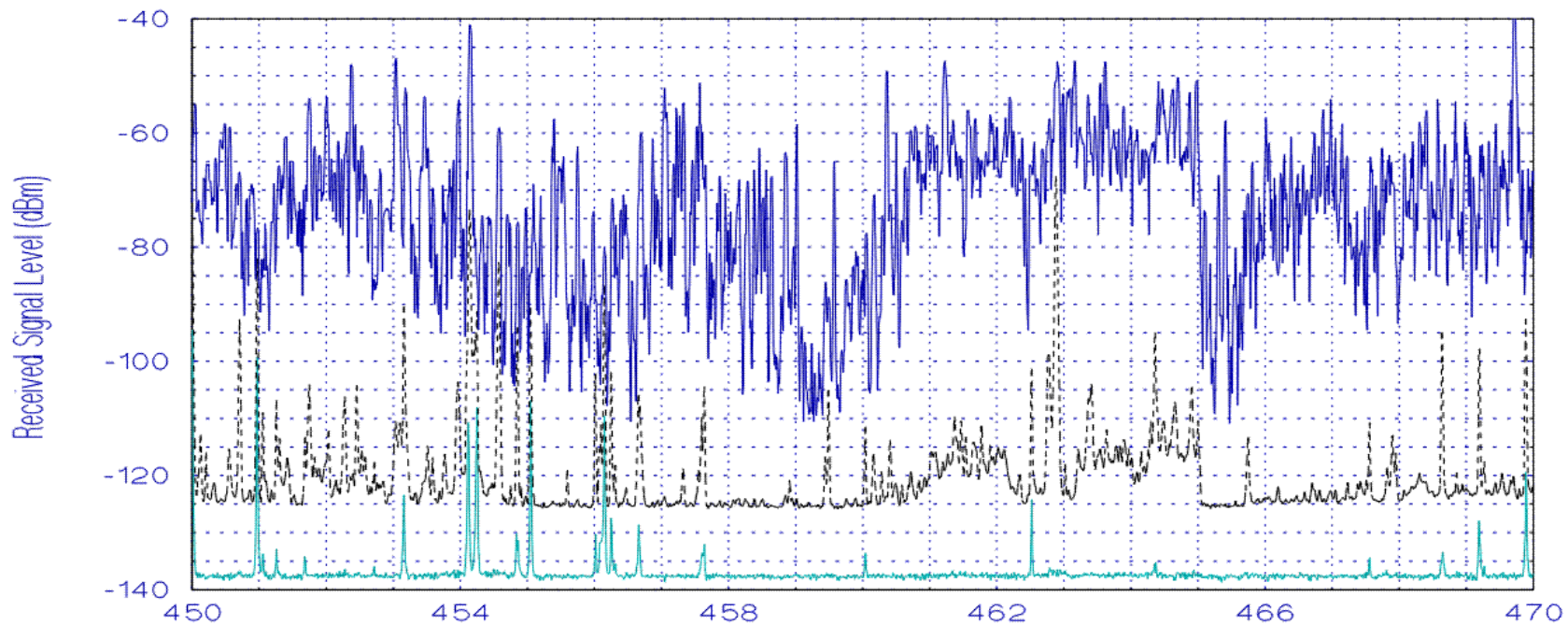

20,400 sweeps across the 450-470 MHz range at San Diego, CA, 1995.
Band event 19, swept/m3 algorithm, sample detector, 10-kHz bandwidth



470-512 MHz band

UHF television broadcasting (chan 14-20) and LMR in selected cities

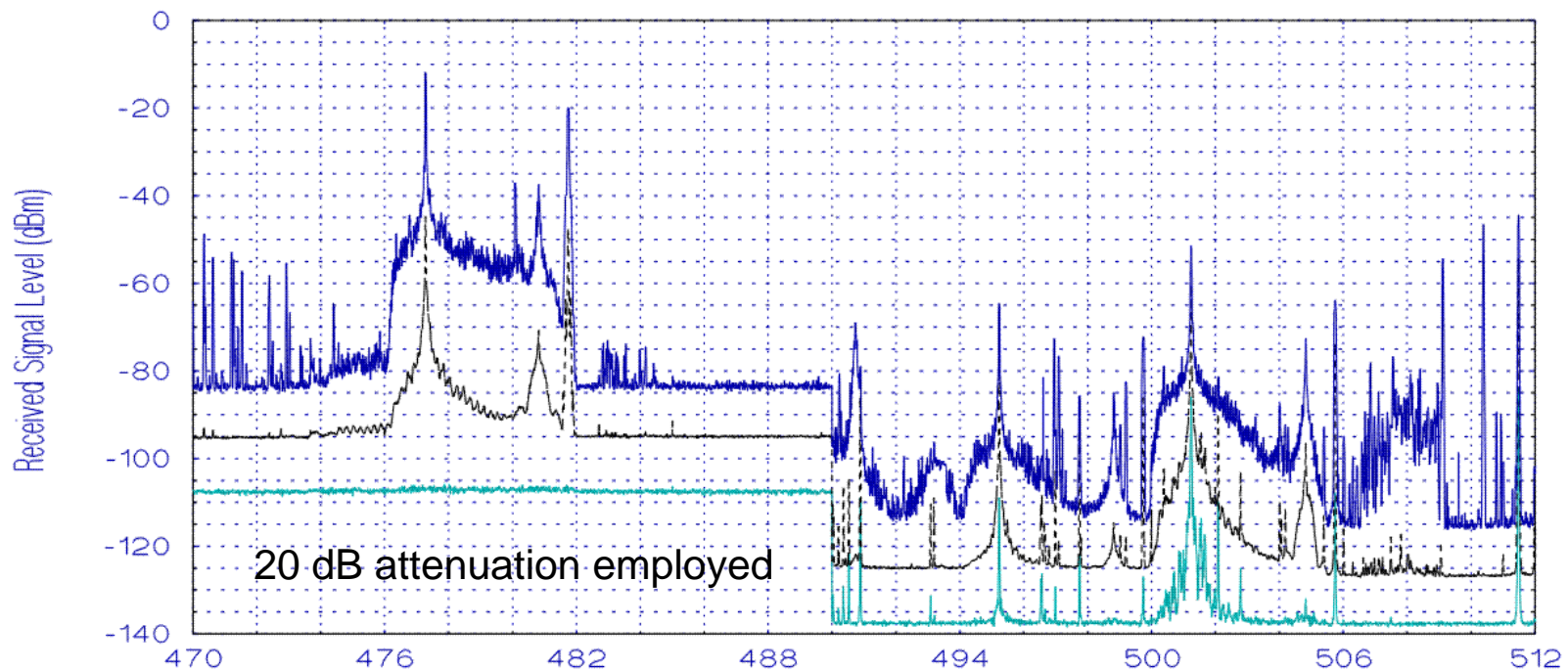

9,600 sweeps across the 470-512 MHz range at San Diego, CA, 1995.
Band event 20, swept/m3 algorithm, sample detector, 10-kHz bandwidth



512-806 MHz band

UHF-TV broadcasting (channels 21-69), channel 37 for radio astronomy

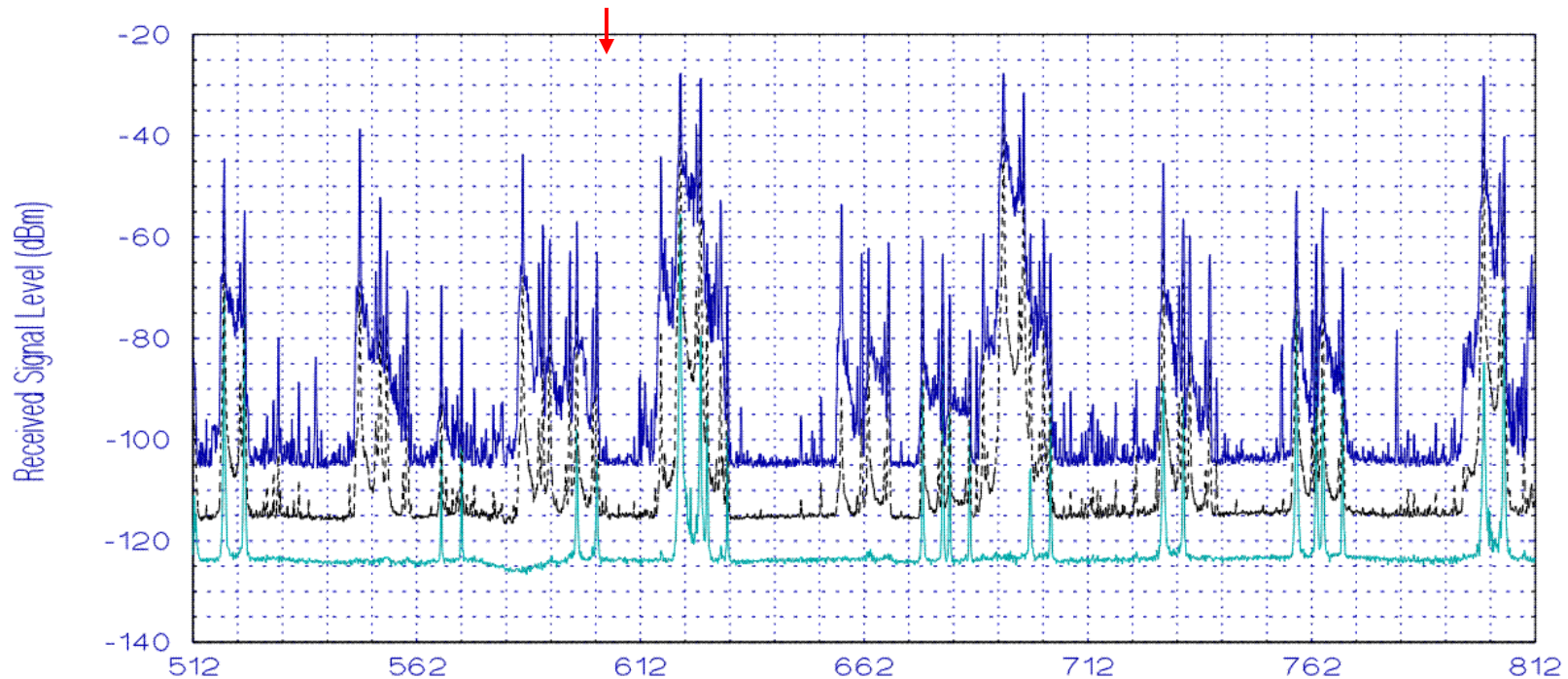

5,800 sweeps across the 512-806 MHz range at San Diego, CA, 1995.
Band event 21, swept/m3 algorithm, sample detector, 100-kHz bandwidth



806-902 MHz band

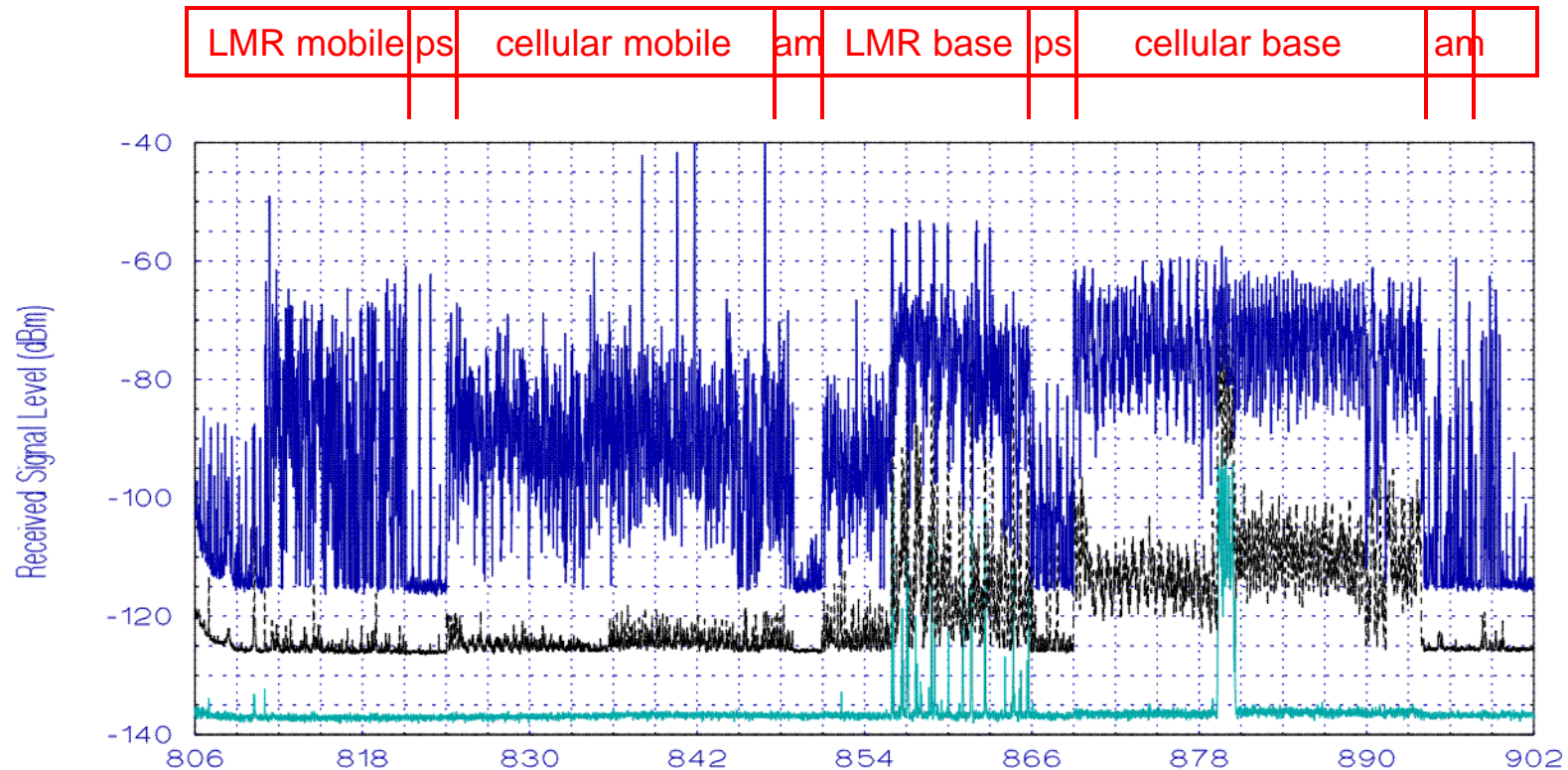

4,020 sweeps across the 806-902 MHz range at San Diego, CA, 1995.
Band event 22, swept/m3 algorithm, sample detector, 10-kHz bandwidth



902-928 MHz band (ISM)

Military radars, ISM devices, automatic vehicle monitoring (AVM), spread spectrum devices, amateur, microwave ovens

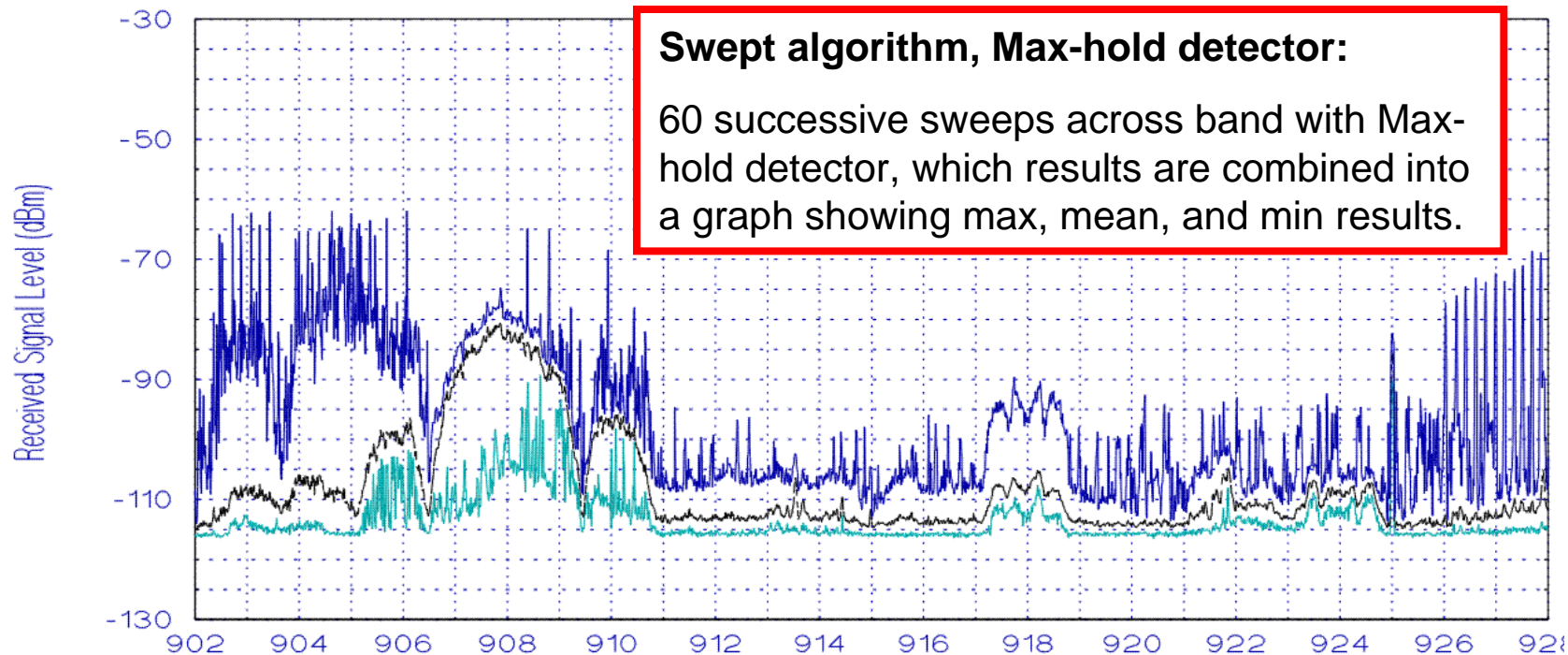

16,800 sweeps across the 902-928 MHz range at San Diego, CA, 1995.
Band event 23, swept algorithm, maximum-hold detector, 10-kHz bandwidth



902-928 MHz band (radar)

Military radars, ISM devices, automatic vehicle monitoring (AVM), spread spectrum devices, amateur, microwave ovens

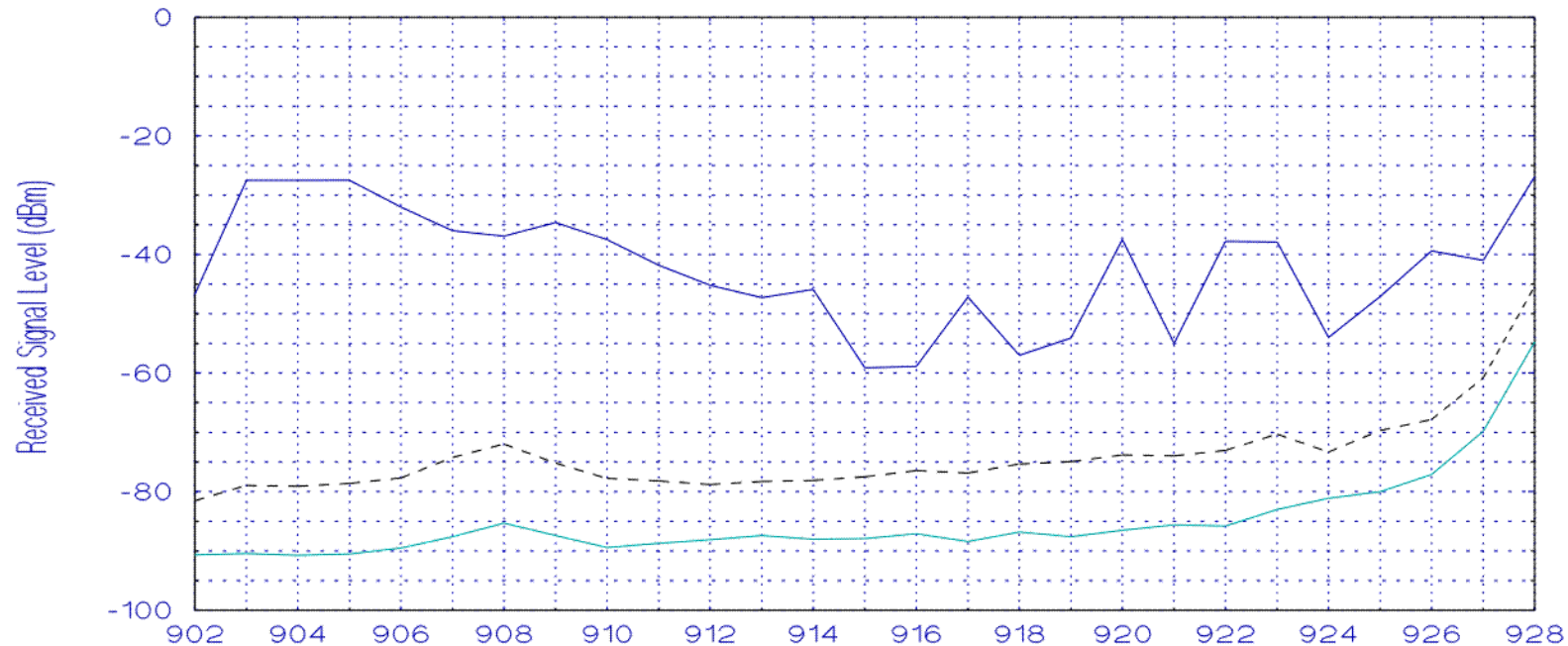

63 scans across the 902-928 MHz range at San Diego, CA, 1995.
Band event 24, stepped algorithm, +peak detector, 1000-kHz bandwidth



928-960 MHz band

F	LMR	fixed	LMR base	fixed	FM STL	fixed
---	-----	-------	----------	-------	--------	-------

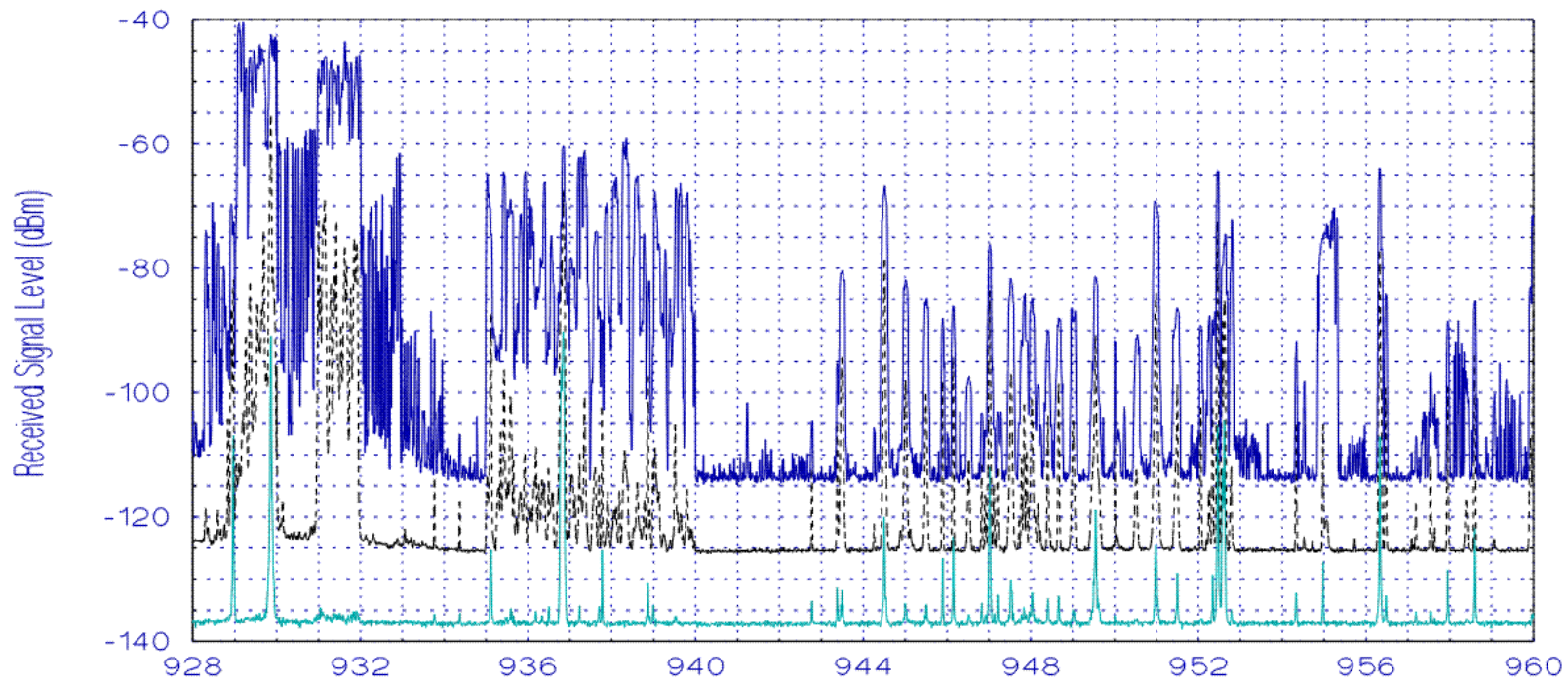

27,600 sweeps across the 928-960 MHz range at San Diego, CA, 1995.
Band event 25, swept/m3 algorithm, sample detector, 10-kHz bandwidth



960-1215 MHz band

Aeronautical RN: TACAN, DME, ATCRBS (1030/1090), JTIDS

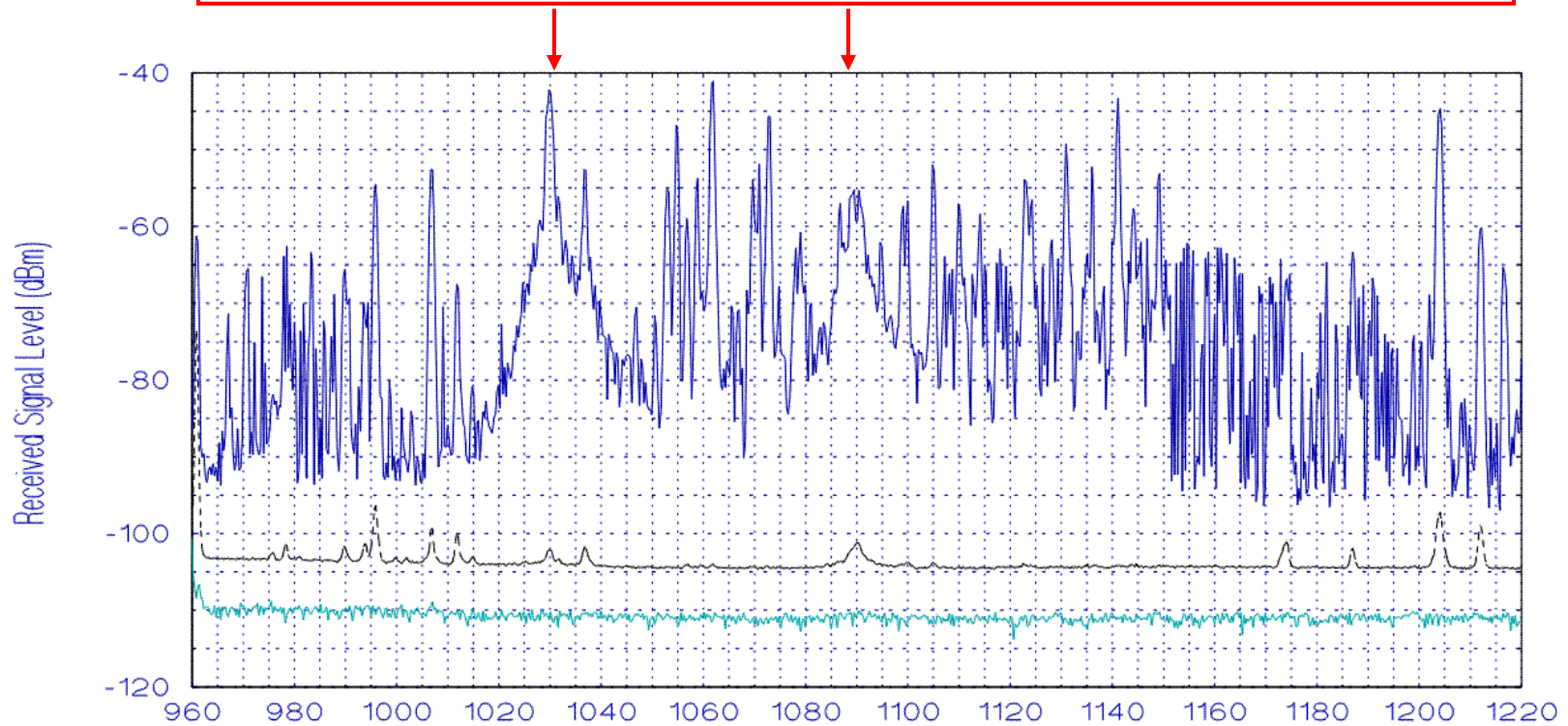

36,500 sweeps across the 960-1215 MHz range at San Diego, CA, 1995.
Band event 05, swept/m3 algorithm, +peak detector, 300-kHz bandwidth



1215-1400 MHz band

Long range L-band search radars, fixed & mobile above 1350

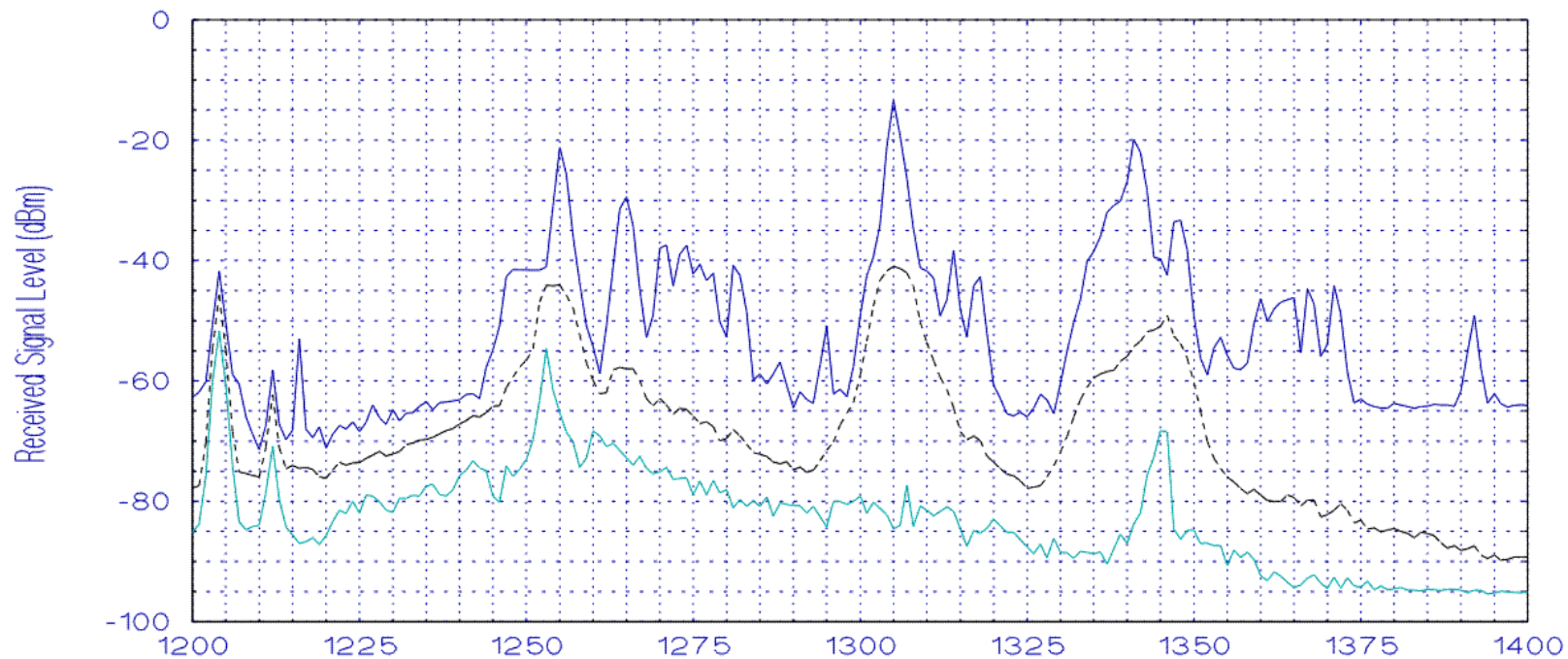

28 scans across the 1215-1400 MHz range at San Diego, CA, 1995.
Band event 06, stepped algorithm, +peak detector, 1000-kHz bandwidth



1400-1530 MHz band

Radio astronomy

aeronautical telemetry

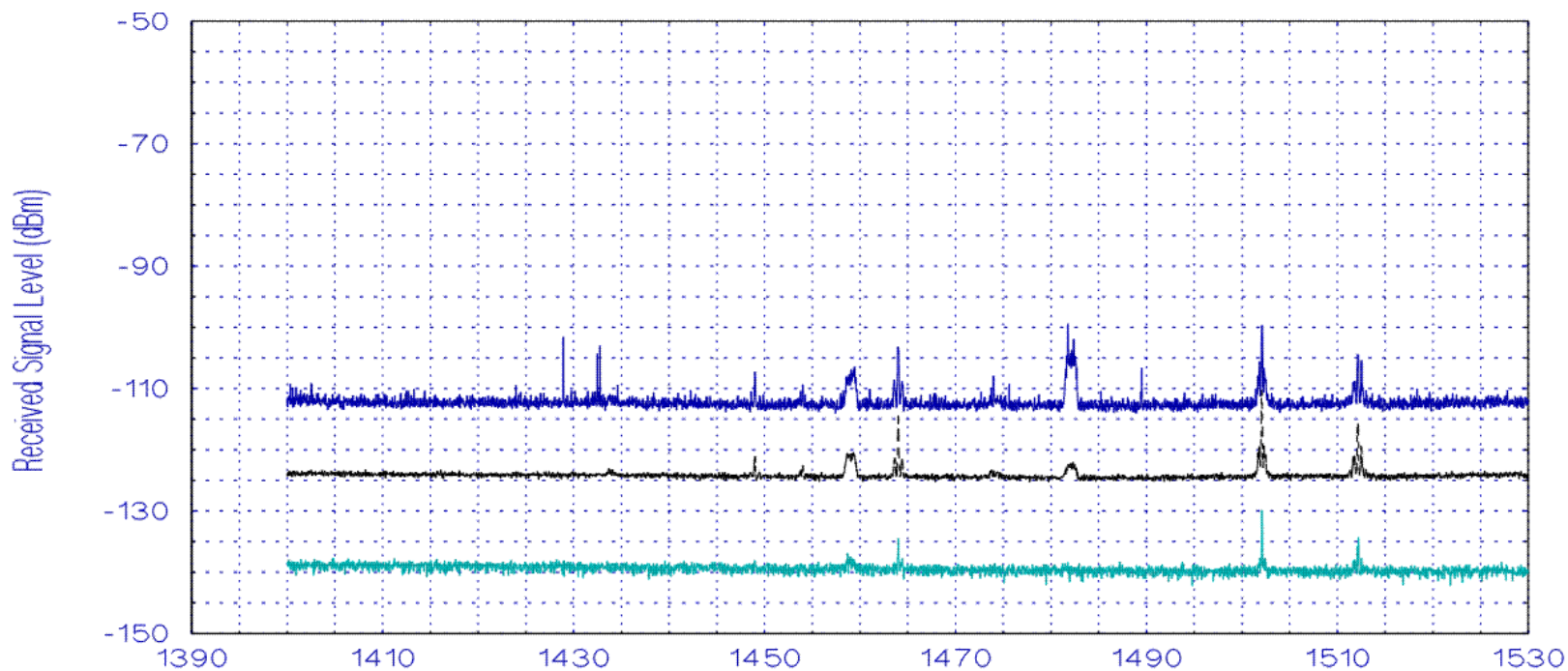

9,600 sweeps across the 1400-1530 MHz range at San Diego, CA, 1995.
Band event 08, swept/m3 algorithm, sample detector, 30-kHz bandwidth



1530-1710 MHz band

Sat-down

GPS/Glonas

satellite uplinks

radiosondes

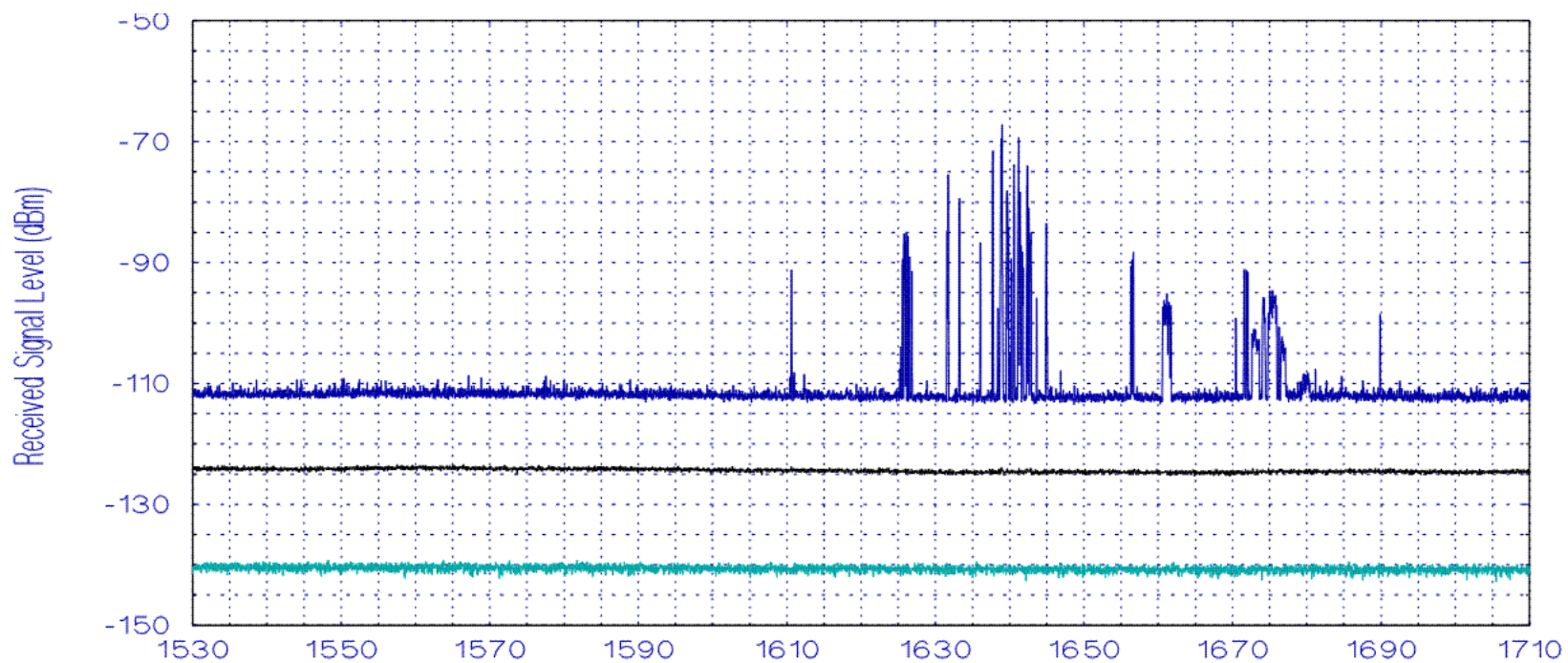

35,000 sweeps across the 1530-1710 MHz range at San Diego, CA, 1995.
Band event 09, swept/m3 algorithm, sample detector, 30-kHz bandwidth



1710-2300 MHz band

Govt pt-pt

commercial pt-pt

Aux BC TV

com pt-pt

Govt mixed

Azimuth scan, using swept max-hold algorithm:

Use high-gain dish antenna aimed at horizon. For each pointing angle, sweep across frequency range using maximum-hold detector to save highest signal seen at each frequency. Re-aim dish antenna one beamwidth and repeat frequency sweep. Continue moving to new antenna angle until 360-degree horizon has been measured.

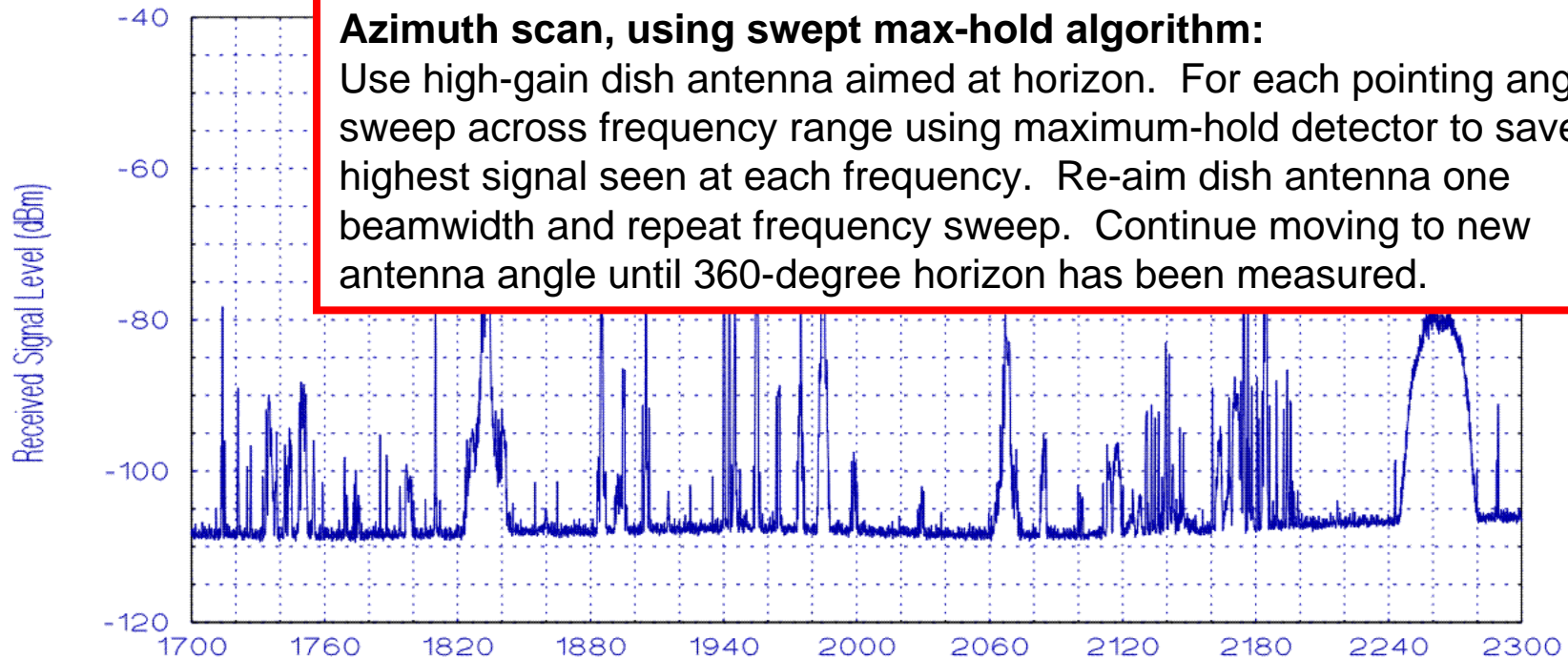

Azimuth-scan graph of the 1710-2300 MHz range at San Diego, CA, 1995.
Band event 10, swept algorithm, maximum-hold detector, 100-kHz bandwidth



2300-2500 MHz band

Mobile/TM 2.3-2.4, Govt radar 2.3-2.45, ISM 2.4-2.5, pt-pt 2.45-2.5

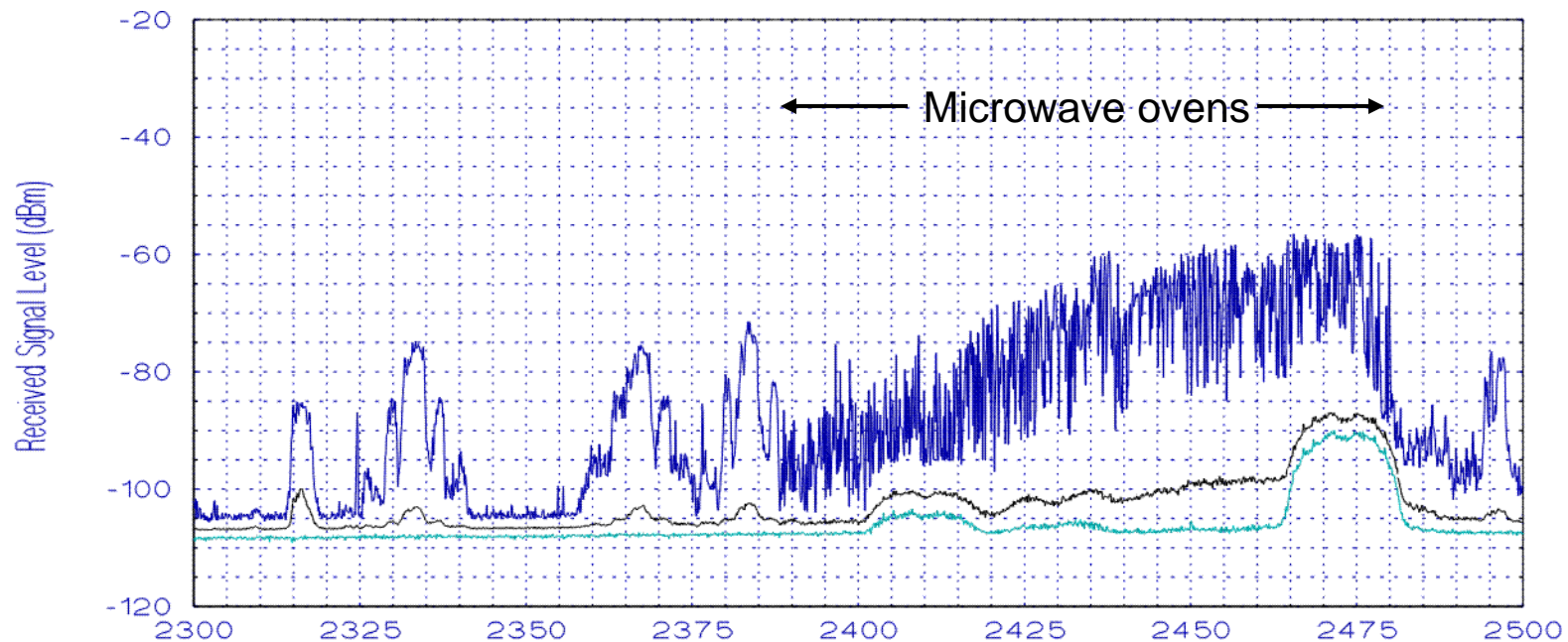

28,800 sweeps across the 2300-2500 MHz range at San Diego, CA, 1995.
Band event 11, swept algorithm, maximum-hold detector, 100-kHz bandwidth



2500-2700 MHz band

MMDS, ITFS, and private pt-pt

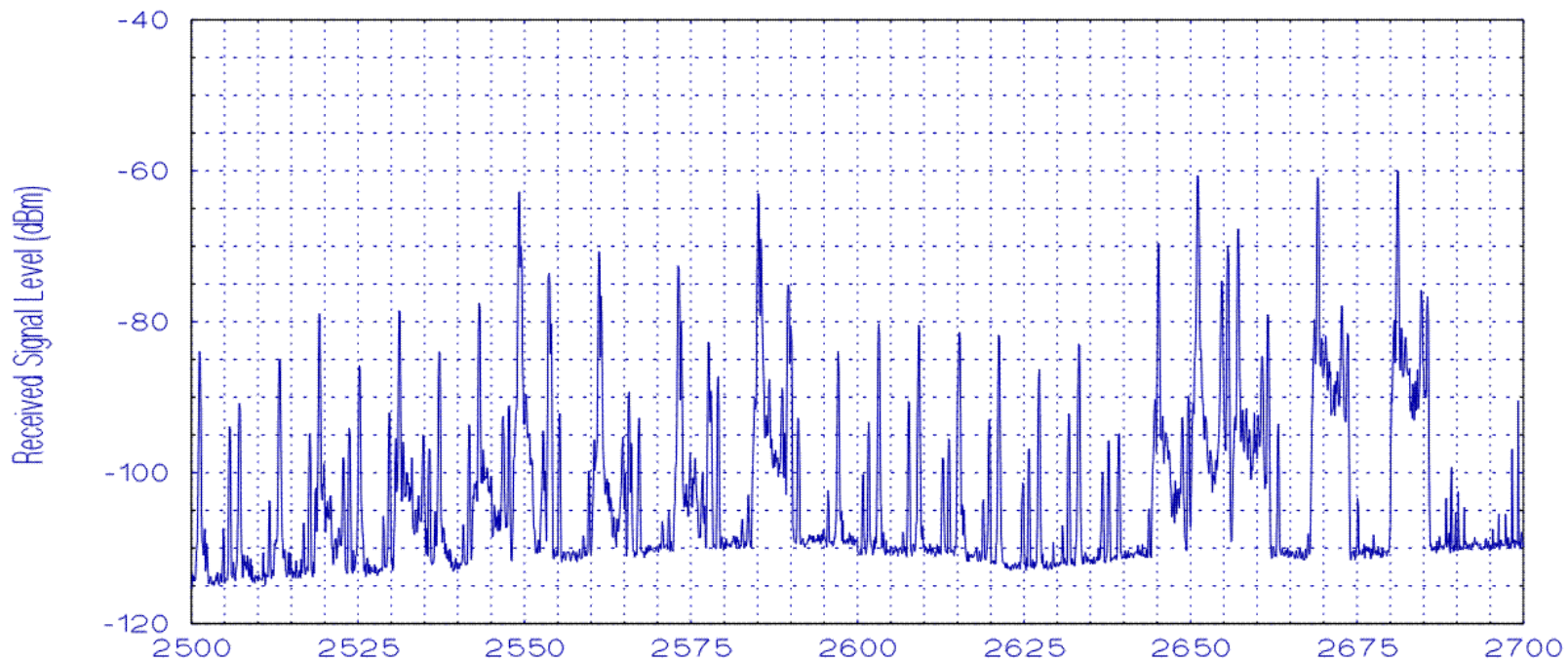

Azimuth-scan graph of the 2500-2700 MHz range at San Diego, CA, 1995.
Band event 12, swept algorithm, maximum-hold detector, 10-kHz bandwidth



2700-2900 MHz band

Airport radars (ASR and GCA) and weather radars

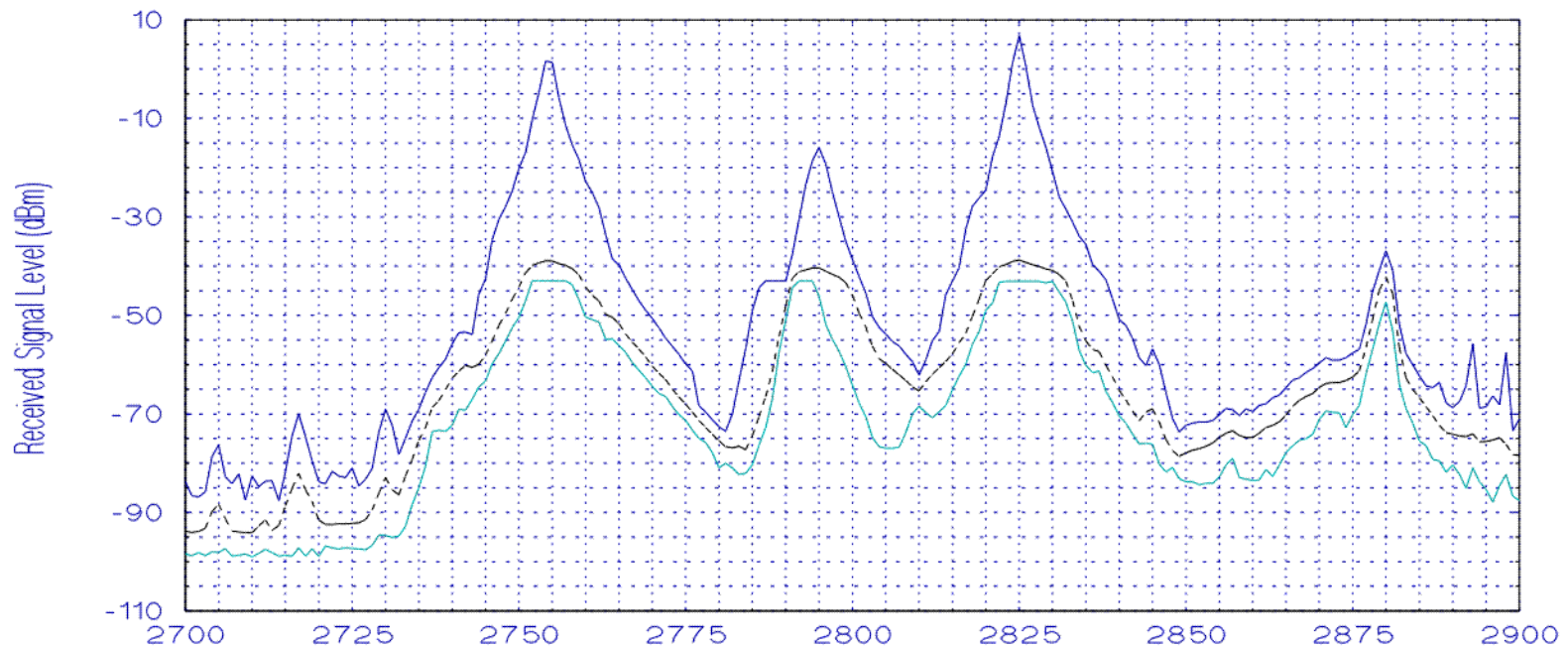

28 scans across the 2700-2900 MHz range at San Diego, CA, 1995.
Band event 13, stepped algorithm, +peak detector, 1000-kHz bandwidth



2900-3100 MHz band

Maritime and military radars

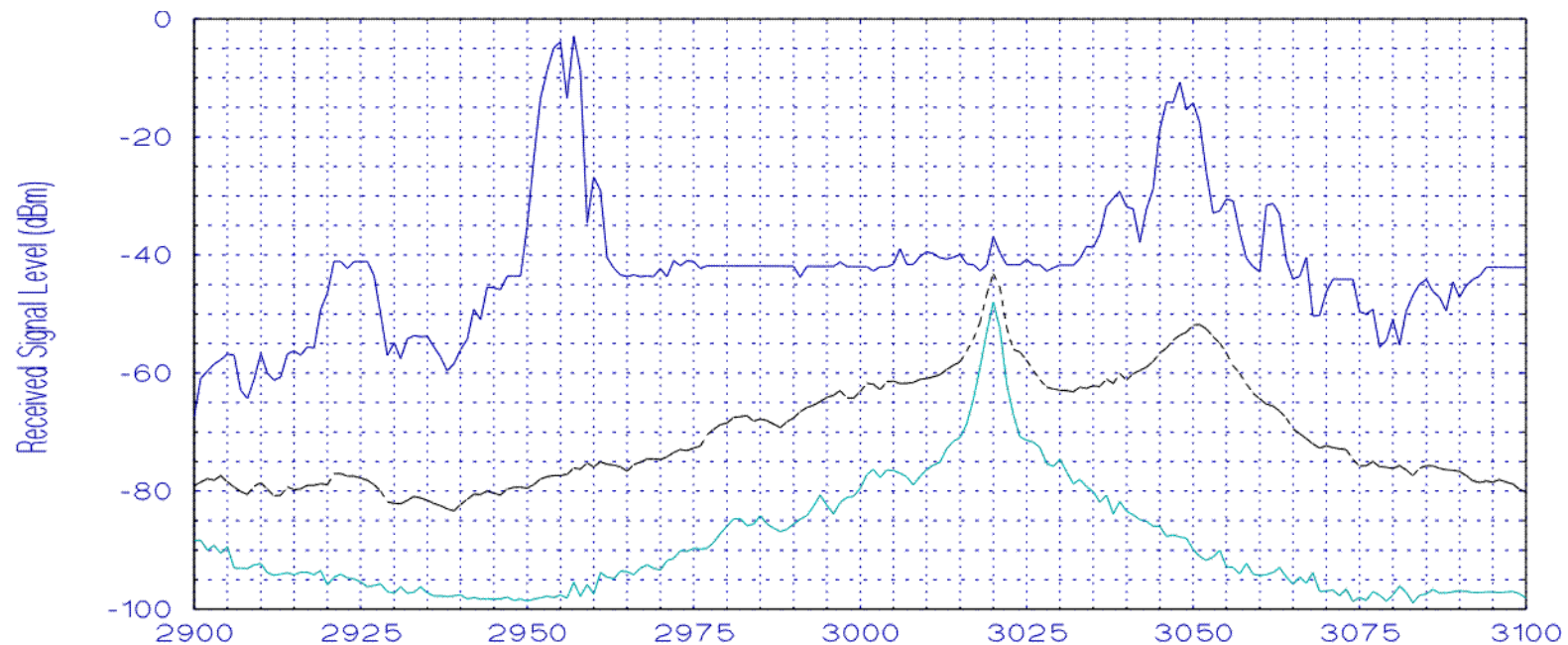

48 scans across the 2900-3100 MHz range) at San Diego, CA, 1995.
Band event 14, stepped algorithm, +peak detector, 1000-kHz bandwidth



3100-3700 MHz band

Military radars

Sat downlink 3.6-3.7

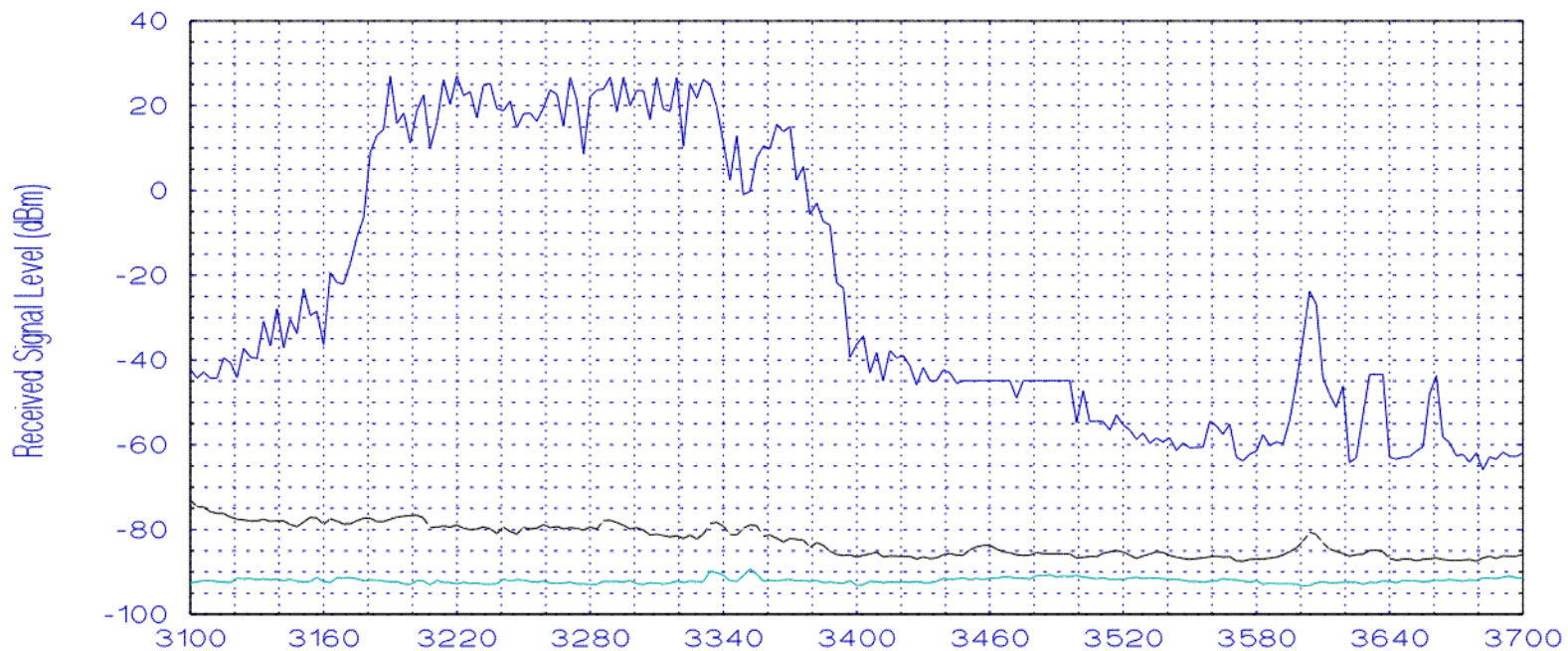

46 scans across the 3100-3700 MHz range at San Diego, CA, 1995.
Band event 15, stepped algorithm, +peak detector, 3000-kHz bandwidth



3700-4200 MHz band

Com Carr pt-pt, fixed satellite downlink

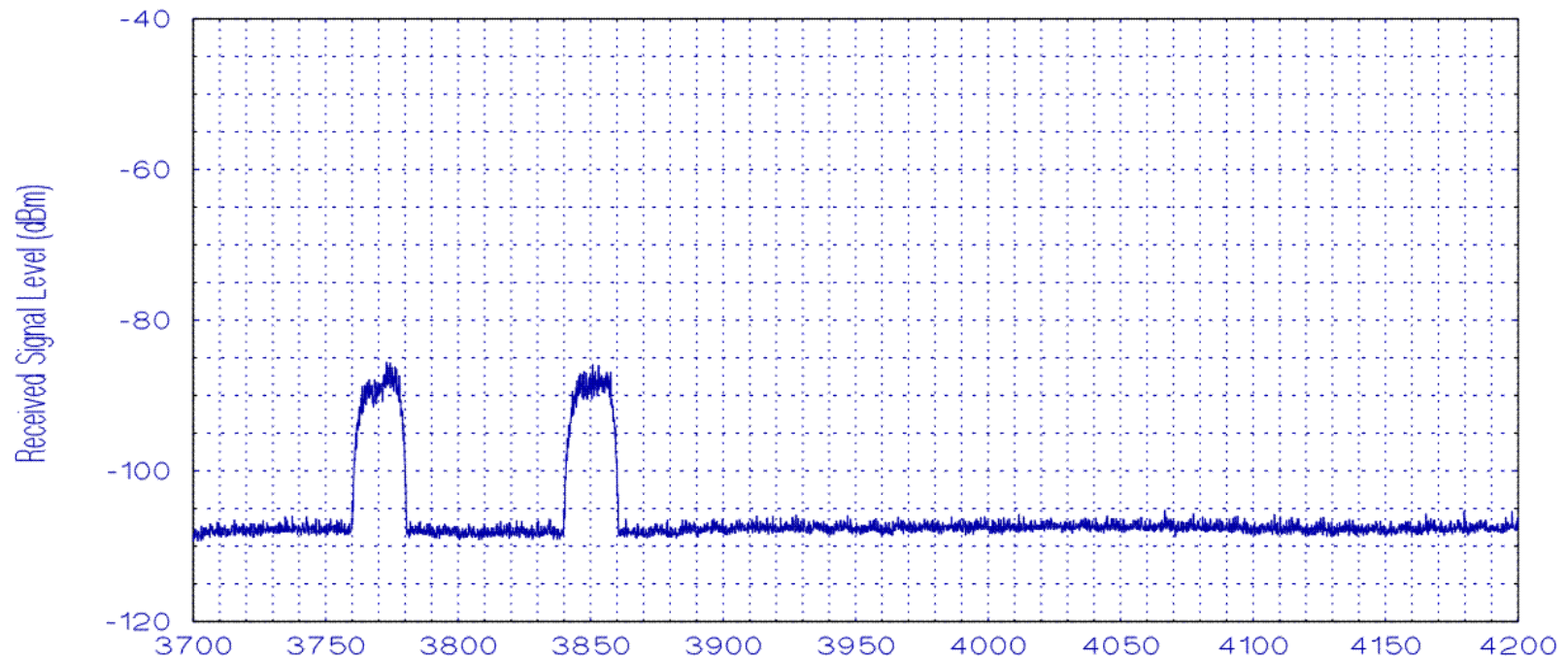

Azimuth-scan graph of the 3700-4200 MHz range at San Diego, CA, 1995.
Band event 16, swept algorithm, maximum-hold detector, 100-kHz bandwidth



4200–4400 MHz band

Radar altimeters

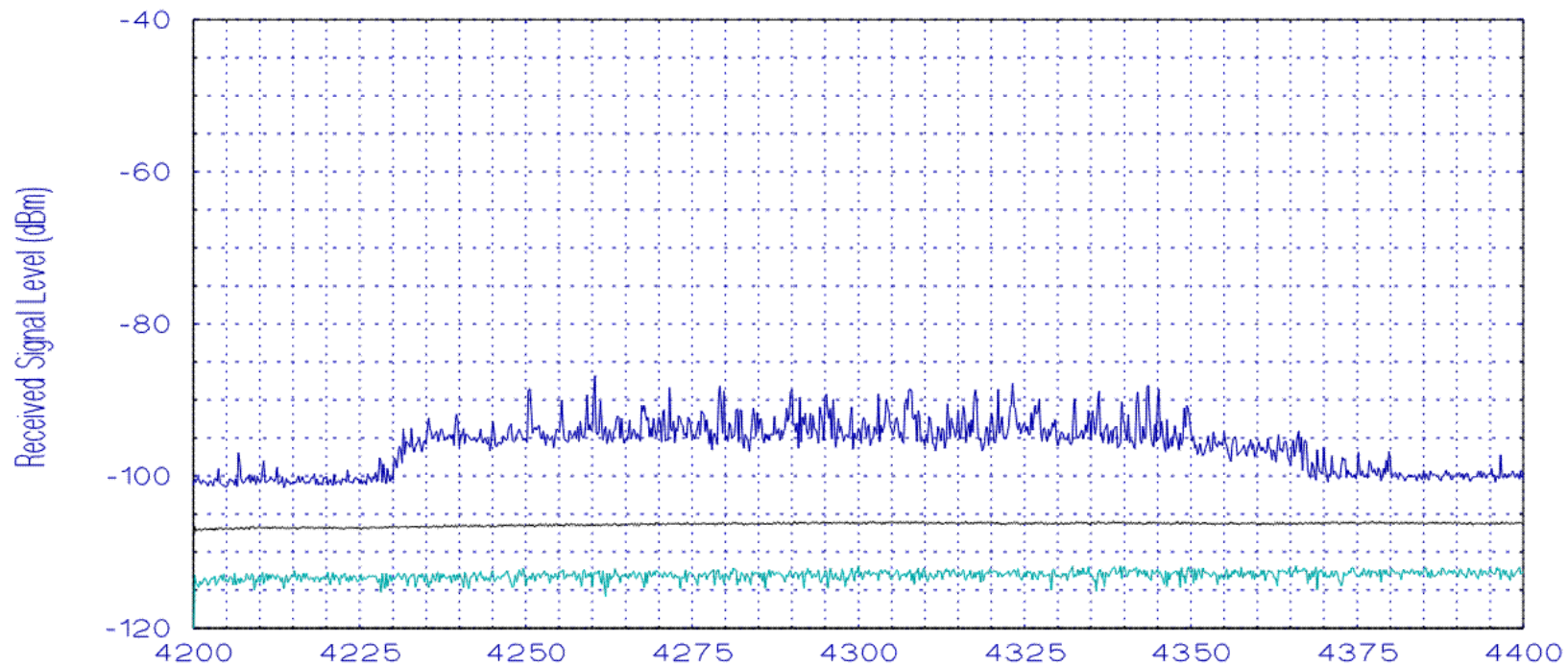

32,500 sweeps across the 4200-4400 MHz range at San Diego, CA, 1995.
Band event 17, swept/m3 algorithm, +peak detector, 300-kHz bandwidth



4400–5000 MHz band

Tactical pt-pt, satellite uplinks and downlinks

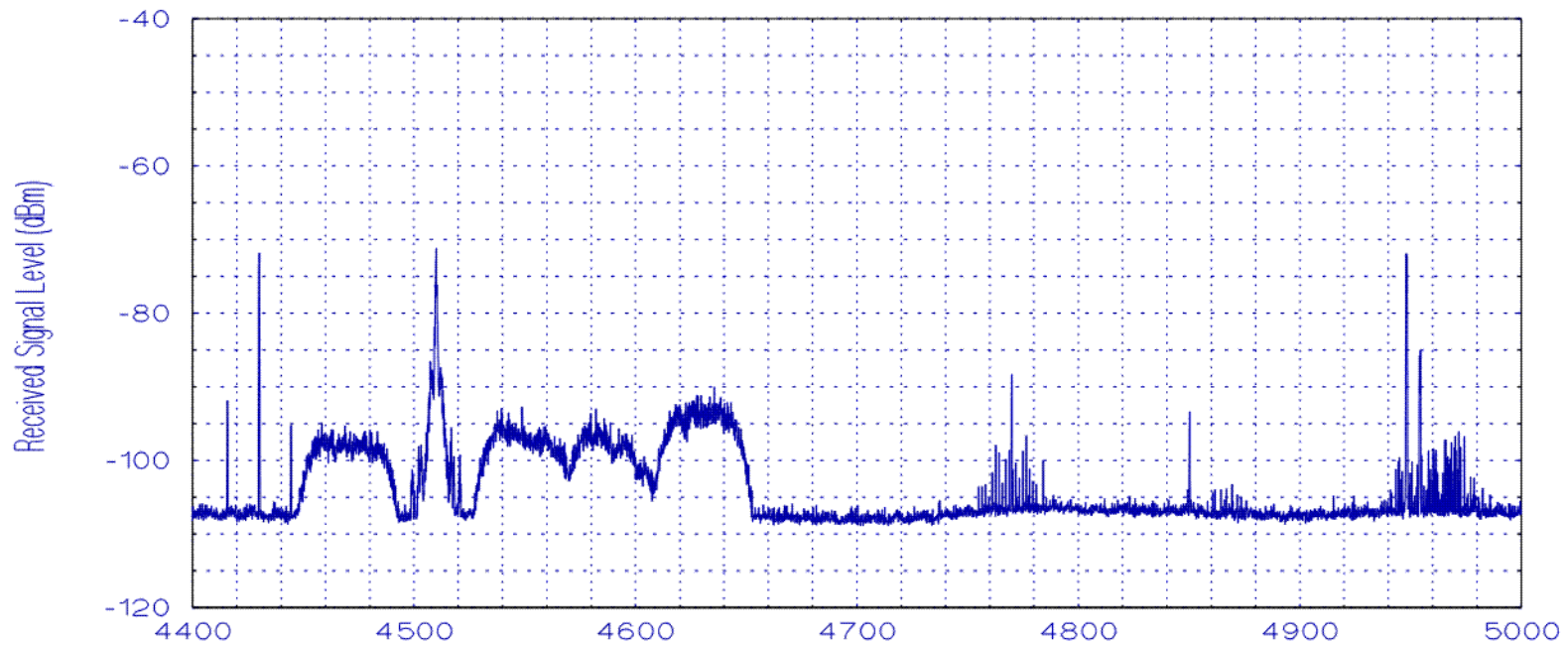

Azimuth-scan graph of the 4400-5000 MHz range at San Diego, CA, 1995.
Band event 18, swept algorithm, maximum-hold detector, 100-kHz bandwidth



5000-5250 MHz band

Microwave landing system (MLS)

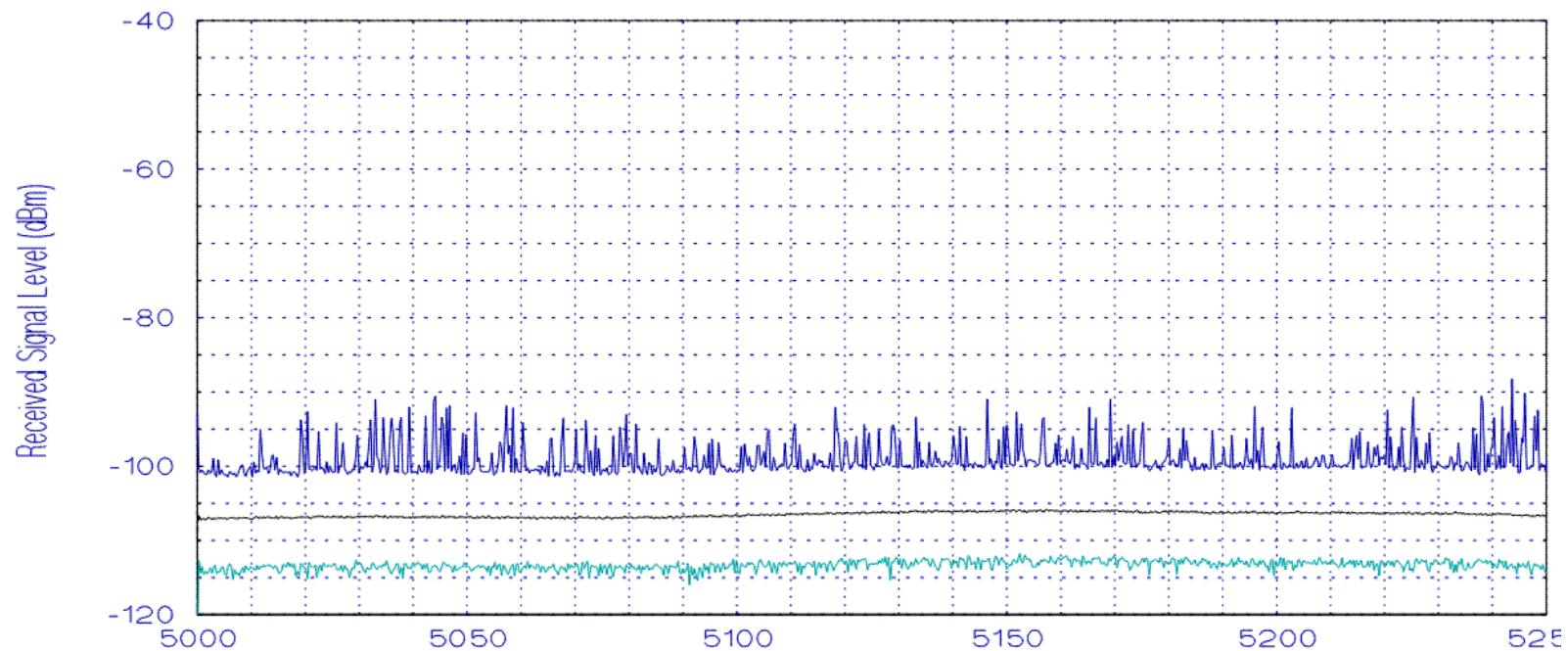

32,000 sweeps across the 5000-5250 MHz range at San Diego, CA, 1995.
Band event 19, swept/m3 algorithm, +peak detector, 300-kHz bandwidth



5250-5925 MHz band

C-band radars: maritime, weather, military. ISM: 5725-5875

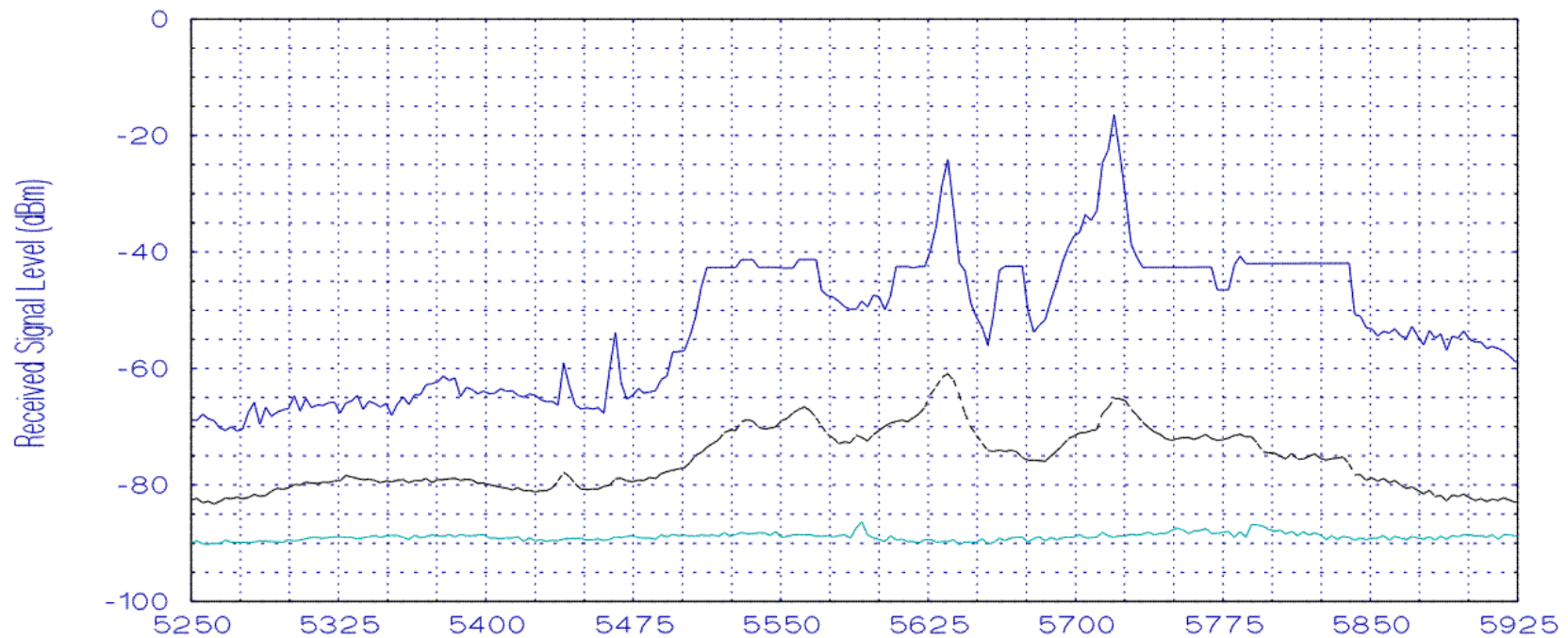

22 scans across the 5250-5925 MHz range at San Diego, CA, 1995.
Band event 20, stepped algorithm, +peak detector, 3000-kHz bandwidth



5925-7125 MHz band

Fixed pt-pt and fixed satellite. 5925 CC 6425 Priv 6875 BAS 7125

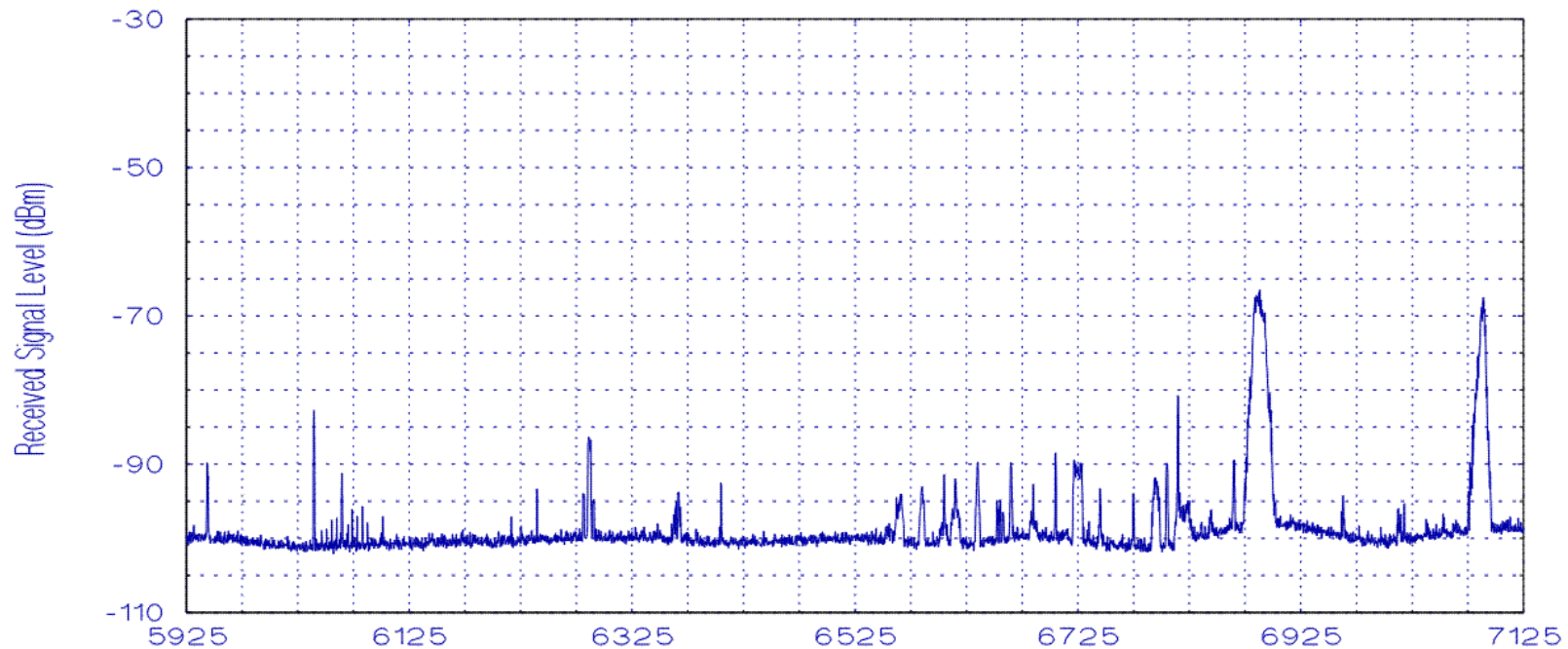

Azimuth-scan graph of the 5925-7125 MHz range at San Diego, CA, 1995.
Band event 21, swept algorithm, maximum-hold detector, 300-kHz bandwidth



7125-8500 MHz band

Govt pt-pt and Govt satellite

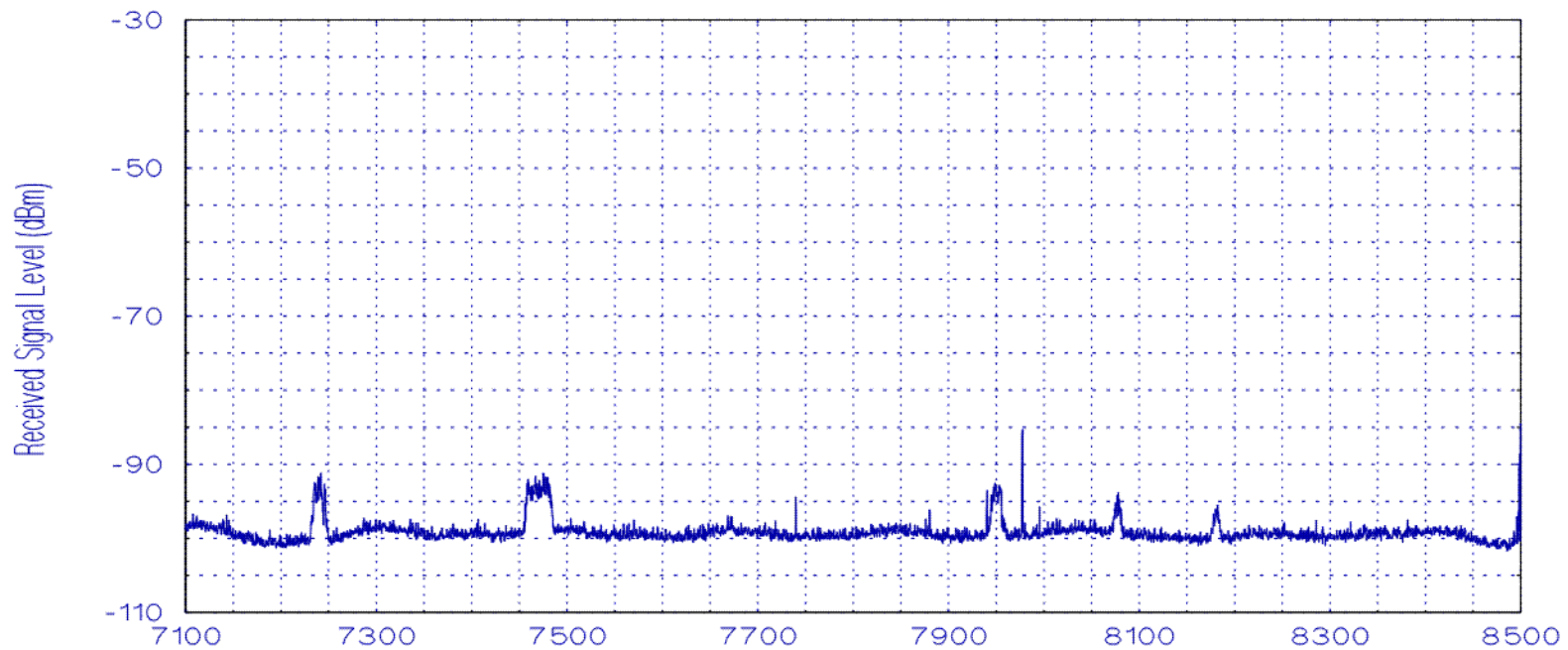

Azimuth-scan graph of the 7125-8500 MHz range at San Diego, CA, 1995.
Band event 22, swept algorithm, maximum-hold detector, 300-kHz bandwidth



8.5-10.5 GHz band

X-band radars: maritime, airborne, airborne weather, racons, etc.

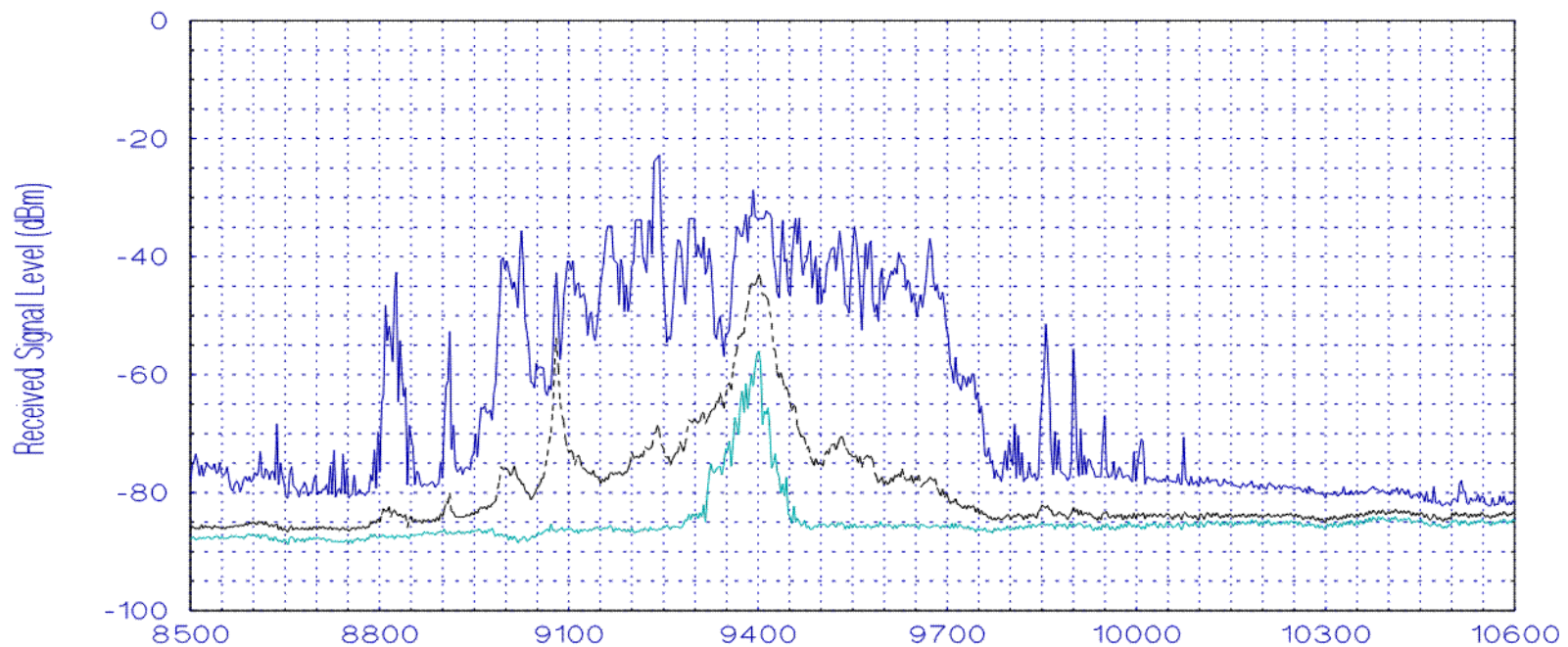

23 scans across the 8500-10550 MHz range) at San Diego, CA, 1995.
Band event 23, stepped algorithm, +peak detector, 3000-kHz bandwidth



10.55-13.25 GHz band

Fixed pt-pt and fixed satellite 10.5-11.7, DBS: 12.2-12.7, CARS: 12.7-13.2

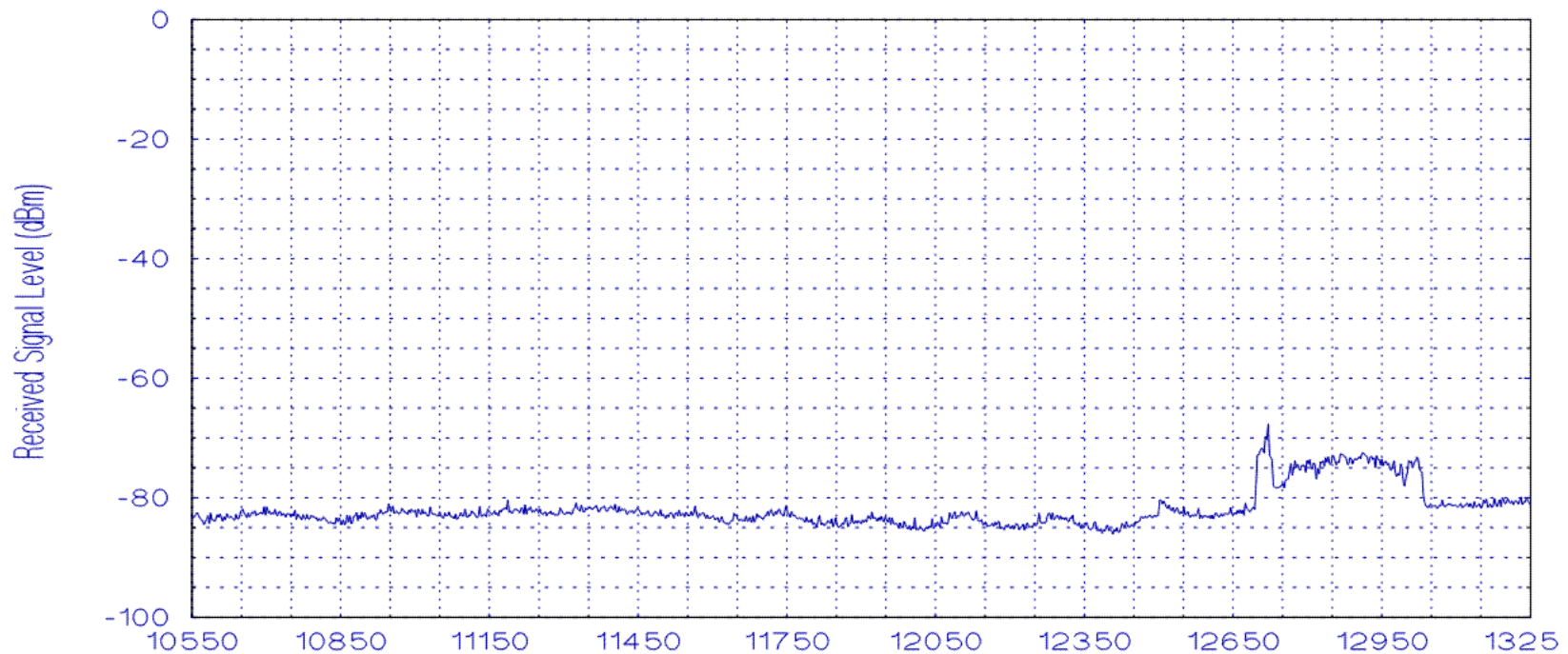

Azimuth-scan graph of the 10550-13250 MHz range at San Diego, CA, 1995.
Band event 24, swept algorithm, maximum-hold detector, 3000-kHz bandwidth



13.25-14.25 GHz band

Radio navigation and space research, airborne military radars

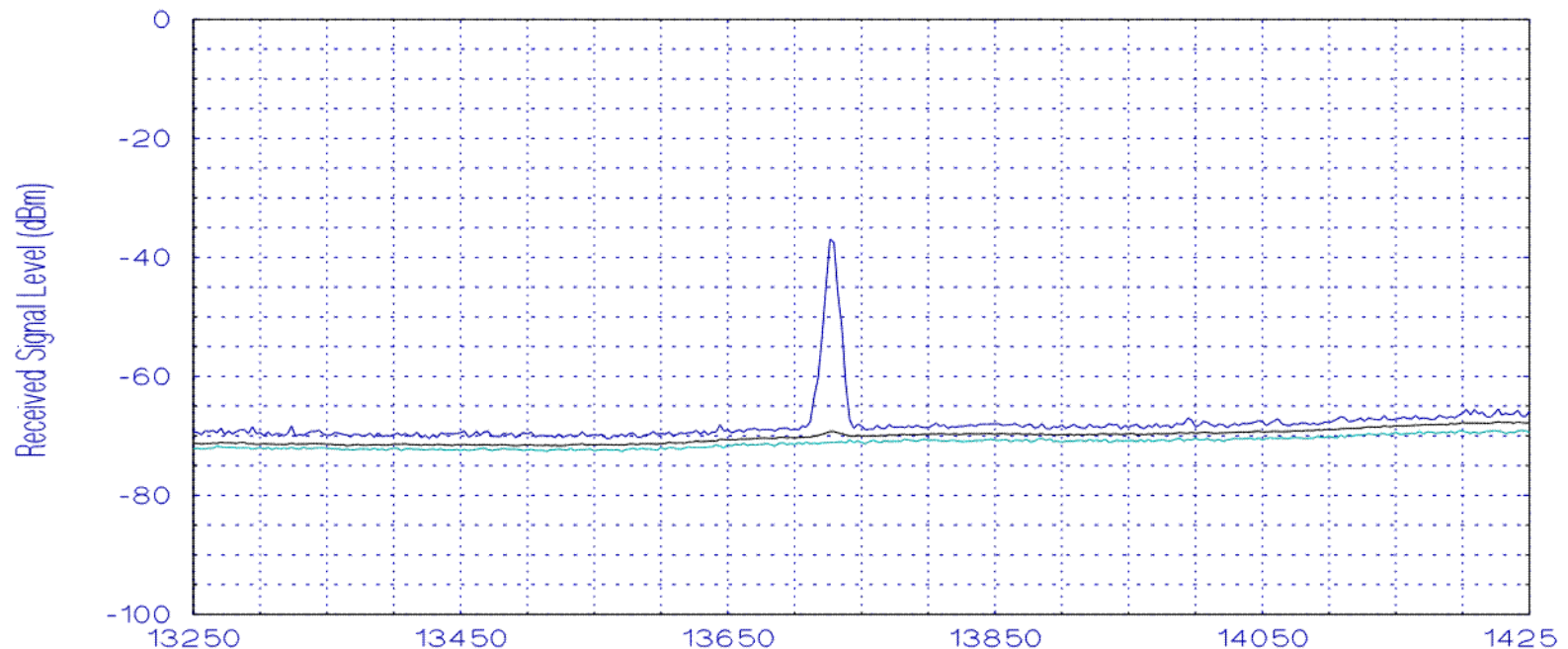

40 scans across the 13250-14200 MHz range at San Diego, CA, 1995.
Band event 25, stepped algorithm, +peak detector, 3000-kHz bandwidth



14.2-15.7 GHz band

Fixed, mobile, satellite

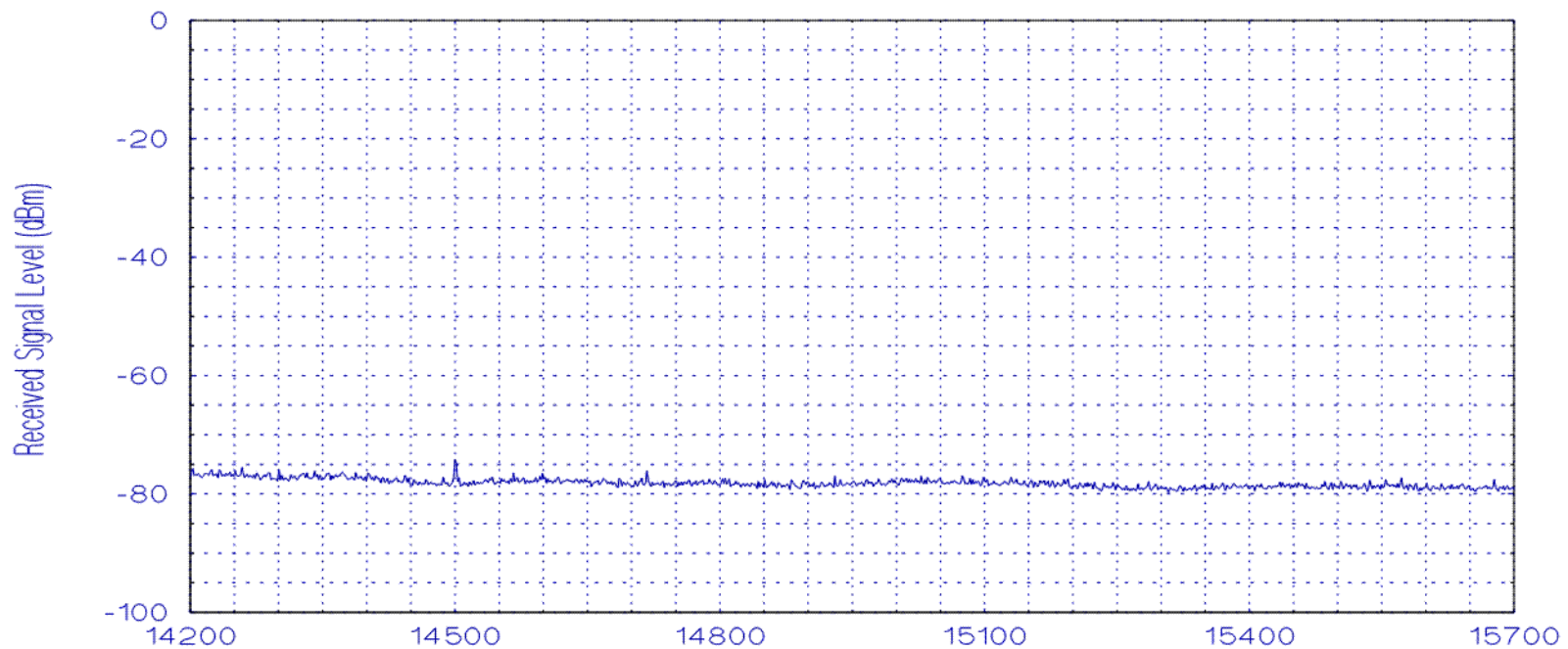

Azimuth-scan graph of the 14200-15700 MHz range) at San Diego, CA, 1995.
Band event 26, swept algorithm, maximum-hold detector, 3000-kHz bandwidth



15.7-17.7 GHz band

Radiolocation, military airborne radars

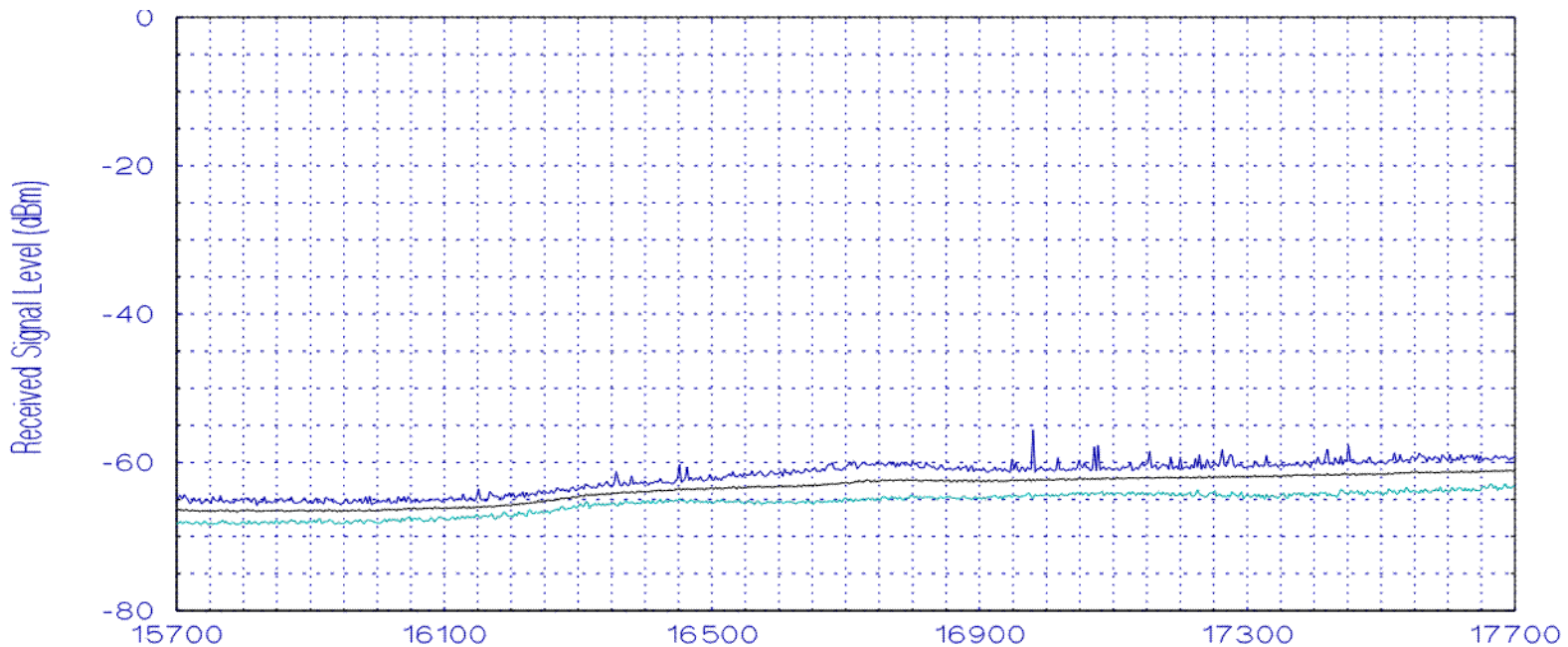

39 scans across the 15700-17700 MHz range at San Diego, CA, 1995.
Band event 27, stepped algorithm, +peak detector, 3000-kHz bandwidth



17.7-19.7 GHz band

Fixed pt-pt and fixed satellite.

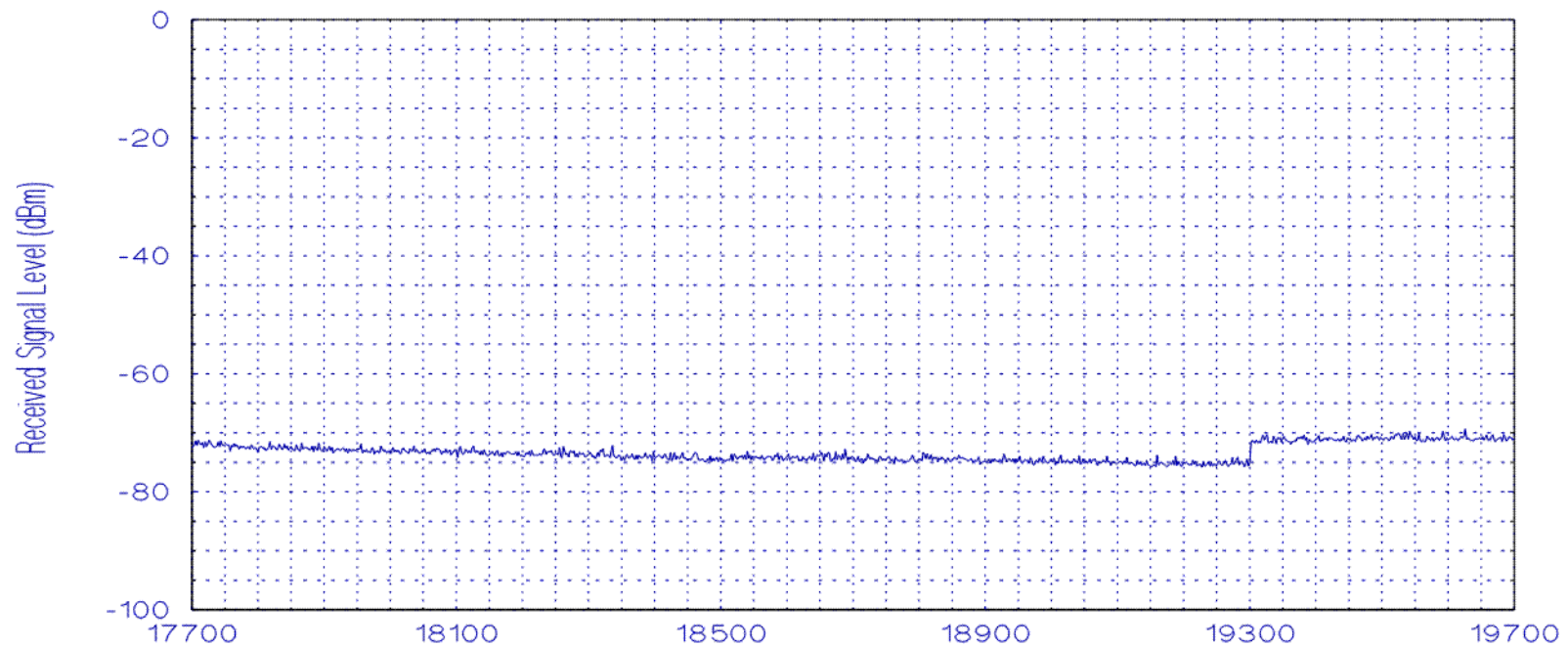

Azimuth-scan graph of the 17700-19700 MHz range at San Diego, CA, 1995.
Band event 28, swept algorithm, maximum-hold detector, 3000-kHz bandwidth



Spectrum Survey Summary

- Some bands are filled with relatively strong signals; others are not. RSMS algorithms do not see all types of signals (e.g., Earth satellites), but good statistical data are obtained on visible signals.
- Noise measurements may require separating signals from noise; may be a difficult job. Part of problem is a usable criterion for what is meant by “signal” and “noise.” Some signal types (e.g. CDMA and UWB) make definitions a little more tricky. *One person’s noise is often another person’s signal.*
 - “Desired signal” and “everything else”? (motivation)
 - “Licensed signal” and “everything else”? (administration)
 - “Include only wideband, impulsive energy? (technical)
- “Stand-off, high-gain” versus “immersion, low-gain” measurement strategies partly a matter of matching user scenarios.



Future Concerns

- Rapidly increasing numbers of licensed and non-licensed devices may increase background noise in operating and nearby bands. UWB devices may affect noise in many bands.
- Frequency management has a goal of providing sufficient $S/N+I$ for a maximum number of users. Some new smart systems may mitigate some interference, via error correction, frequency shifting, etc. These systems designed for noisier environments.
- What levels and types of “interference” optimize the utility of available spectrum? Are current interference levels higher or lower than desirable? What is happening in ISM and other non-licensed bands? How can interference be best defined, regulated, measured, predicted, especially for dynamic spectrum sharing?