

Electrically Small Antenna Design

Anja K. Skrivervik and Jean-François Zürcher
Ecole Polytechnique Fédérale de Lausanne
CH-1015 Lausanne, Switzerland
anja.skrivervik@epfl.ch

- What is a small antenna ?
 - Introduction
- What is the problem ?
 - Physical limitations on small antennas
- How can we solve the problem ?
 - Design strategies and examples

1898, in Paris

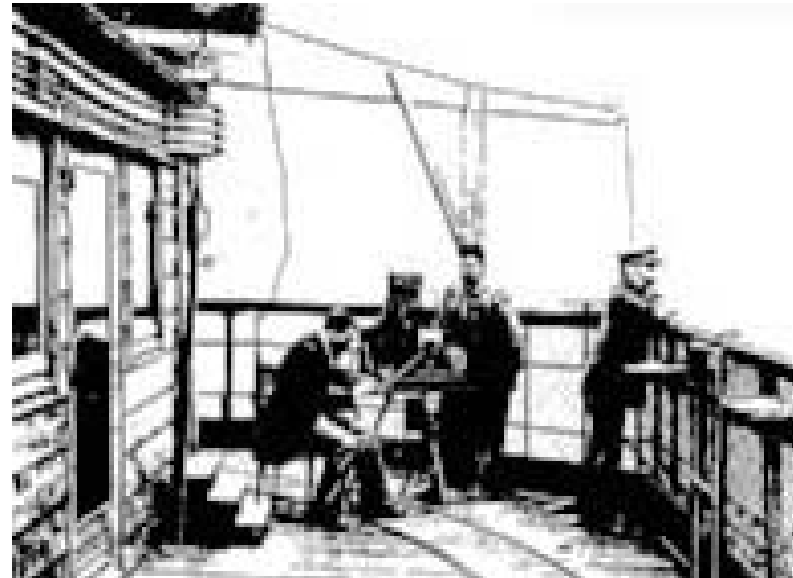
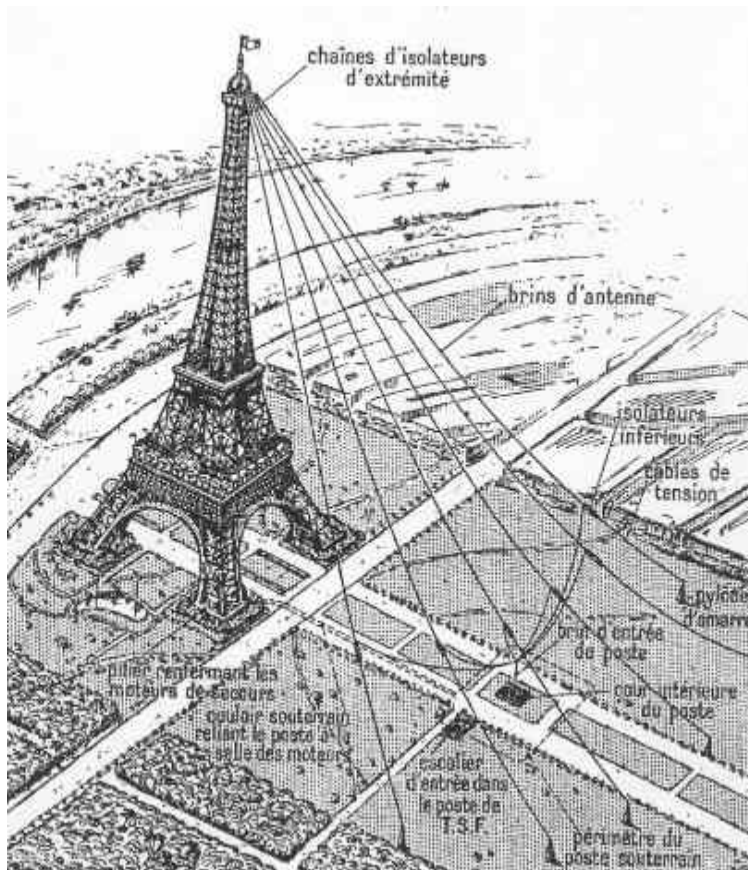

Size of the antenna : a few fractions of wavelengths

100 years later ...

Innovative Antennas

efficiencies as high as 70 or 80%

Antenova has revealed an innovative form of antenna that liberates wireless developers from the problems and restrictions associated with conventional technology. Among the capabilities that this technology can offer are fine control over directionality, extremely small size with virtual immunity to detuning - allowing multiple antennas to be integrated onto PCBs - solid-state steerability, narrow or broadband configuration, and much higher efficiencies. The technology results from three years of pioneering R&D that has transformed the effect of dielectric resonance from a scientific curiosity into a

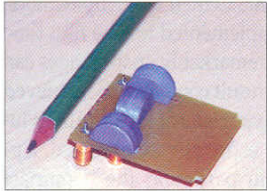

completely characterized technology - backed by a design methodology and computer-aided tools. Another important capability is the means to design broadband antennas to suit products such as mobile phones, or extremely narrowband versions to eliminate the conventional need for external passband filters. The antennas themselves can be as small as a tenth of the size of a conventional product, as well as much more sensitive - efficiencies as high as 70 or 80% are easily achievable. **Antenova Ltd**, Far Field House, Albert Road, Stow-cum-Quy, Cambridge CB5 9AR, UK, Tel: +44-1223-810616, Fax: +44-1223-810650.

InfoCard: Enter No: **2604**
Online: www.eelink.com

- Size of the antenna : a tenth of wavelength
- Max. 3 dB bandwidth : 1.5 %

The problem is the same !!!

What is a small antenna ?

near/far field boundaries

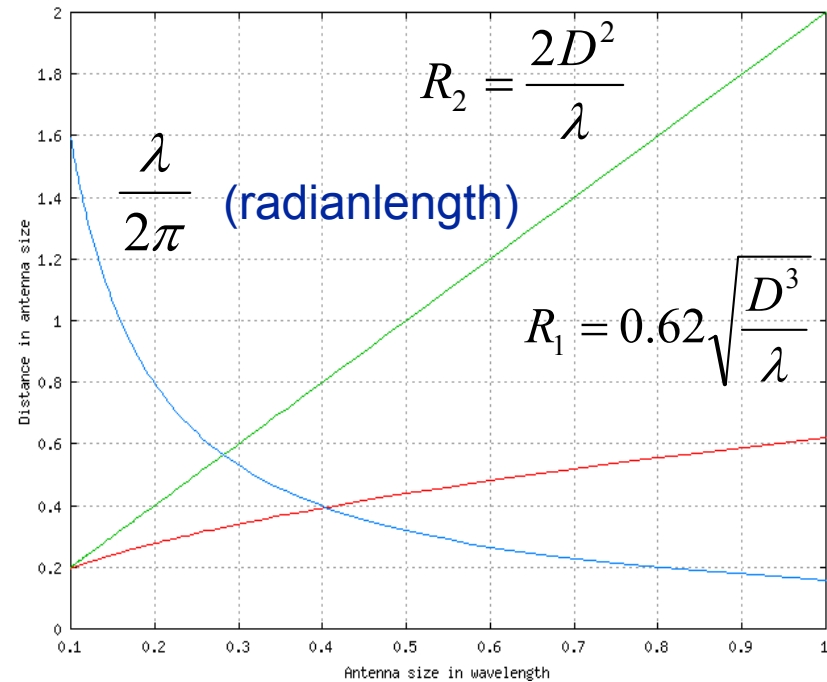
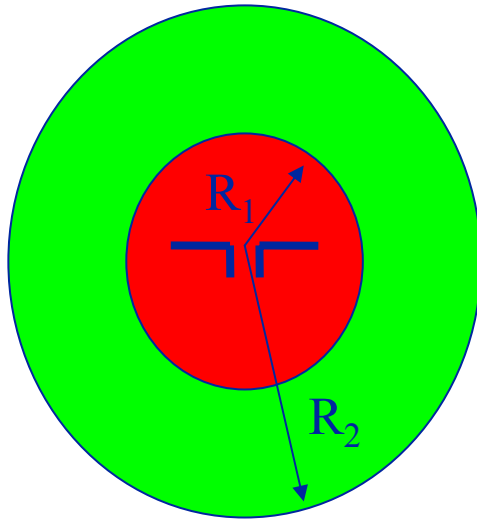

Wheeler:

- $\lambda/3$

Usually:

- $\lambda/2$

Why small antennas ?

System	Frequency [MHz]
GSM (2G)	900 / 1800 / 1900
UMTS (3G)	1955 / 2155
DECT	1890
PHS	1900
CT 2	866
GPS	1575
Satellite link	1620 (up) / 2490 (down)
Pager	< 900

The wavelength is between 14 cm and 35 cm.



On a portable device, the antenna is between a fifth and a tenth of a wavelength.

Application example



Physical limitations on small antennas

Where are the limitations ?

- Limitations on the bandwidth
 - Theoretical minimum Q as a function of the size (Chu, Harrington, Fano, Fante, McLean, Collin, etc.).
- Limitations on the efficiency
 - Theoretical maximum gain as a function of the size (Harrington).

Minimum quality factor

The antenna is approximated by a RLC circuit; and at resonance:

$$Q = \frac{\omega W}{P}$$

If the circuit is matched by a lossless network:

$$Q = \frac{2\omega W_e}{P} \text{ for } W_e > W_m$$

$$Q = \frac{2\omega W_m}{P} \text{ for } W_e < W_m$$

and

$$B_{3dB} = \frac{1}{Q}$$

valid for $Q \gg 1$

Minimum quality factor

- The antenna is enclosed in the smallest possible sphere.
- The fields are represented by spherical waves functions.

Main problem: Evaluation of the energy stored in the reactive field.

- Chu: Equivalent ladder network (leading to an approximation).
 - L.J. Chu, Journal of Appl. Physics, vol. 19, pp. 1163-1175, 1948
- Collin, Fano, Fante, McLean: Directly from the fields.
 - see for instance J.S. Mc Lean, IEEE Trans on AP, vol. AP-44, pp. 672-675, 1996

Lowest possible Q for linearly polarized antennas

Q

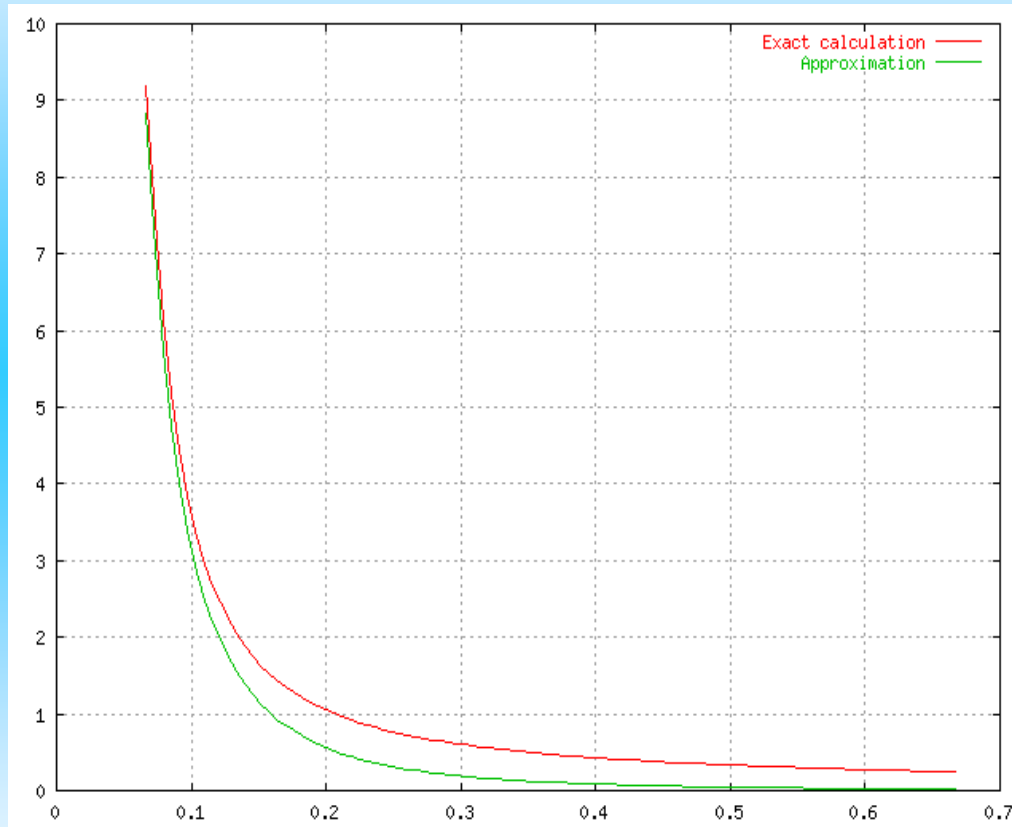

a/λ

$$Q_{\min} = \frac{1}{ka} + \frac{1}{(ka)^3}$$

$$Q_{\min} = \frac{1 + 2(ka)^2}{(ka)^3 (1 + (ka)^2)}$$

Lowest possible Q for circularly polarized antennas

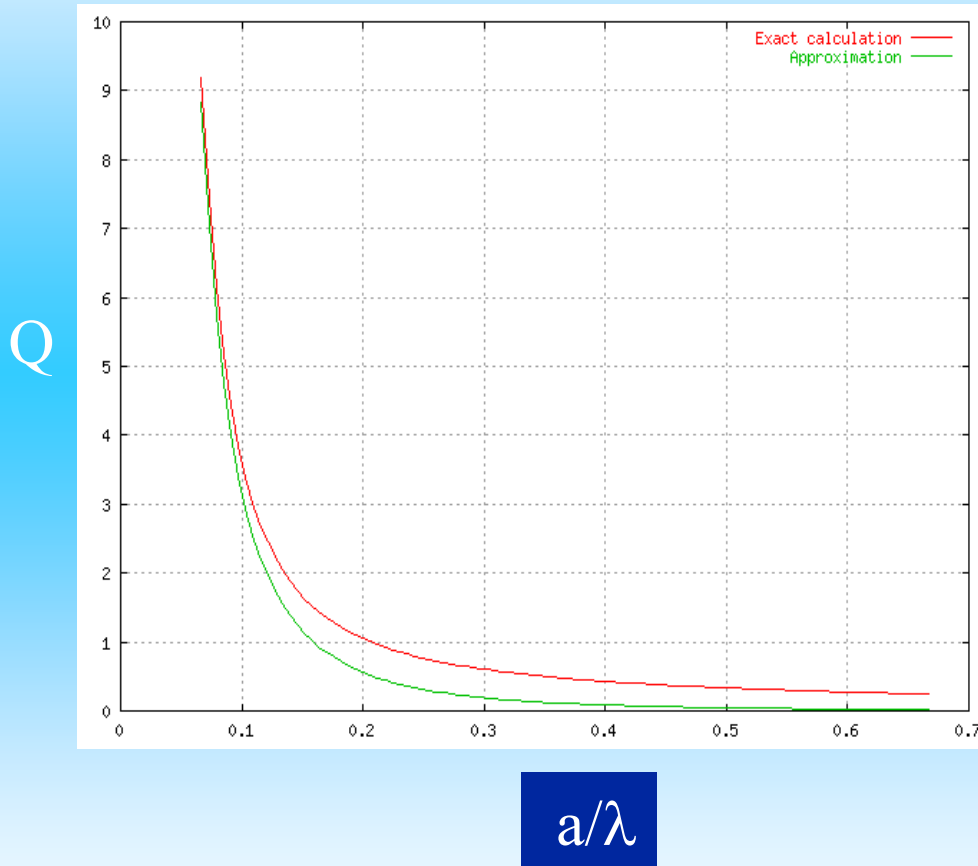

$$Q_{\min} = \frac{1}{2} \left(\frac{1}{k^3 a^3} + \frac{2}{ka} \right)$$

$$Q_{\min} = \frac{1}{2} \left(\frac{1 + 2(ka)^2}{(ka)^3 (1 + (ka)^2)} \right)$$

Q in presence of losses

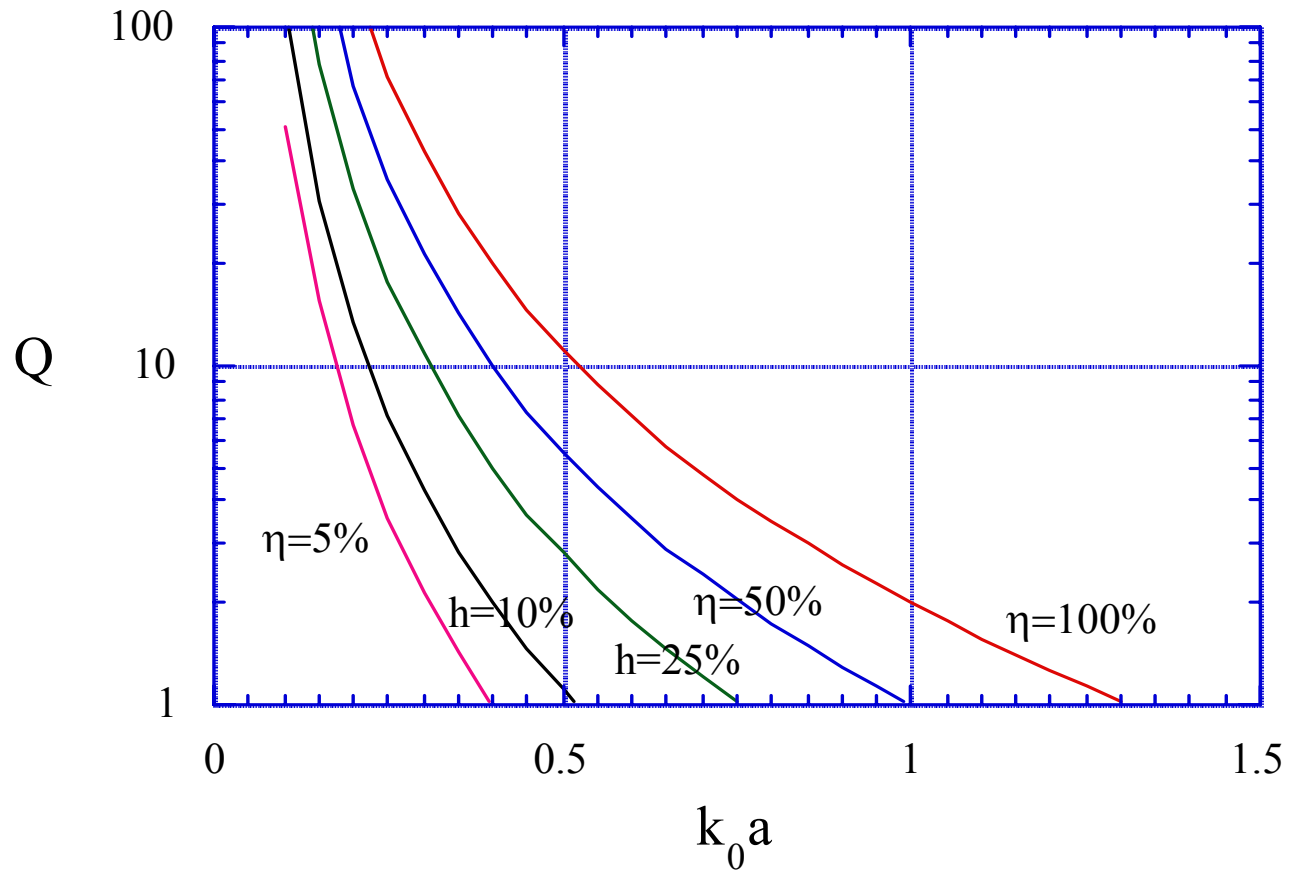

Maximum gain of an antenna

- The gain is defined as

$$G(\theta) = \frac{4\pi r^2 S_r(\theta)}{\overline{P_f}},$$

- Where S_r is the r component of the Poynting vector and P_f is the total radiated power, obtained integrating S_r over a large sphere

Maximum gain of an antenna : intuitive approach

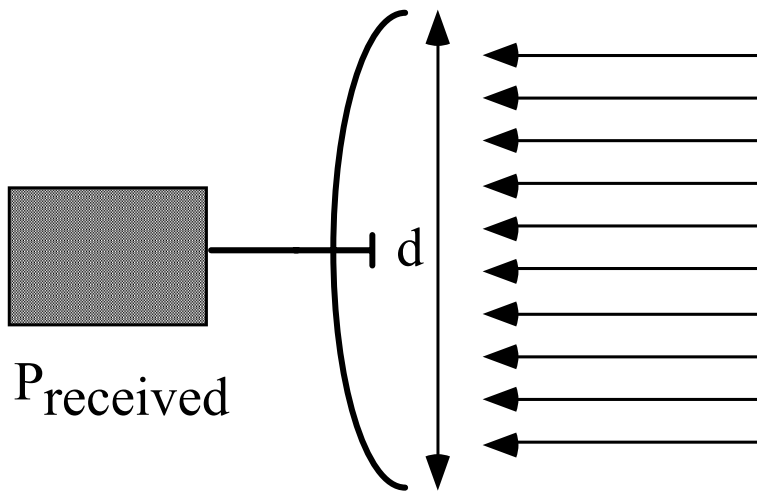

incoming plane wave
Power density : p

$$P_{\text{received}} = p A_e (\theta, \varphi)$$

$A_e (\theta, \varphi)$: *effective aperture*
or effective surface

Parabolic dish

$$P_{\text{received}}^{\text{max}} = p \pi \frac{d^2}{4} \rho_A \quad , \quad \rho_A \leq 0.82$$

$$G (\theta, \varphi) = \frac{4\pi}{\lambda^2} A_e (\theta, \varphi) \quad , \quad G^{\text{max}} = \left(\frac{\pi d}{\lambda} \right)^2 \rho_A$$

Maximum gain of an antenna

Harrington, IRE Trans on AP, vol. AP-6, pp. 219-225, 1958

- The fields are expressed in spherical waves outside the sphere enclosing the antenna
- The Poynting vector is computed in the far field
- The gain expressed in spherical modes is obtained from the Poynting vector
- The gain is maximized with respect to the size of the sphere enclosing the antenna

Maximum gain of an antenna

- After some cumbersome calculs and limiting the number of spherical modes (wave functions) to N , we finally obtain :

$$G = N^2 + 2N$$

Thus, if the number of modes can be increased, the gain has potentially no limit

Maximum gain of an antenna

- What effects do limit the gain :
 - Possibility to manufacture an antenna radiating many propagating modes
 - Losses (higher order modes have usually higher losses)
 - Bandwidth (the more modes, the smaller the bandwidth)

Practical gain limitation

$$G(\theta) = \frac{4\pi r^2 S_r(\theta)}{P_f}$$

$$G = N^2 + 2N$$

Wave impedance
of a TM wave

$$Z_{+r}^{TM} = \frac{j\eta}{kr} + \frac{\eta}{|h_n^{(2)}|^2} \left[\frac{2}{\pi kr} + j(j_n j_n' + n_n n_n') \right]$$

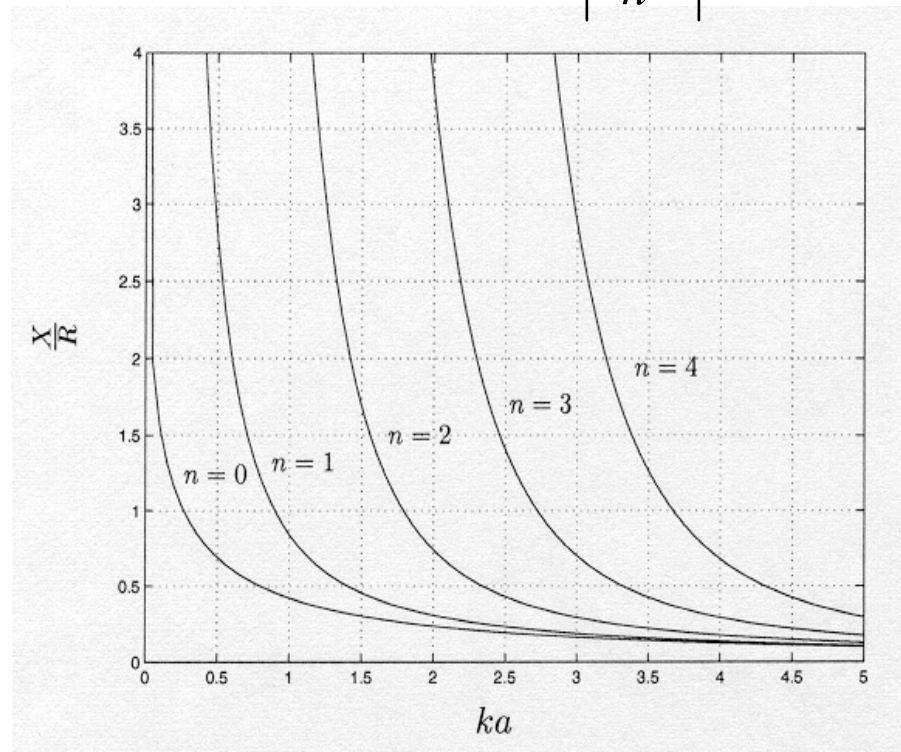

Practical gain limitation

- The wave impedance is reactive when $j_n j_n' + n_n n_n'$ is large compared to $2/\pi k r$
- n_n increases rapidly when $kr < n$
- The modes of order $n > ka$ are rapidly cut off and are not naturally present in the field of an antenna of radius a
- Modes of order $n > ka$ will increase heavily the stored reactive energy, but have no impact on radiated power

Maximum gain for a practical bandwidth : $N = ka$

$$G_{normal} = (ka)^2 + 2ka$$

G [dBi]

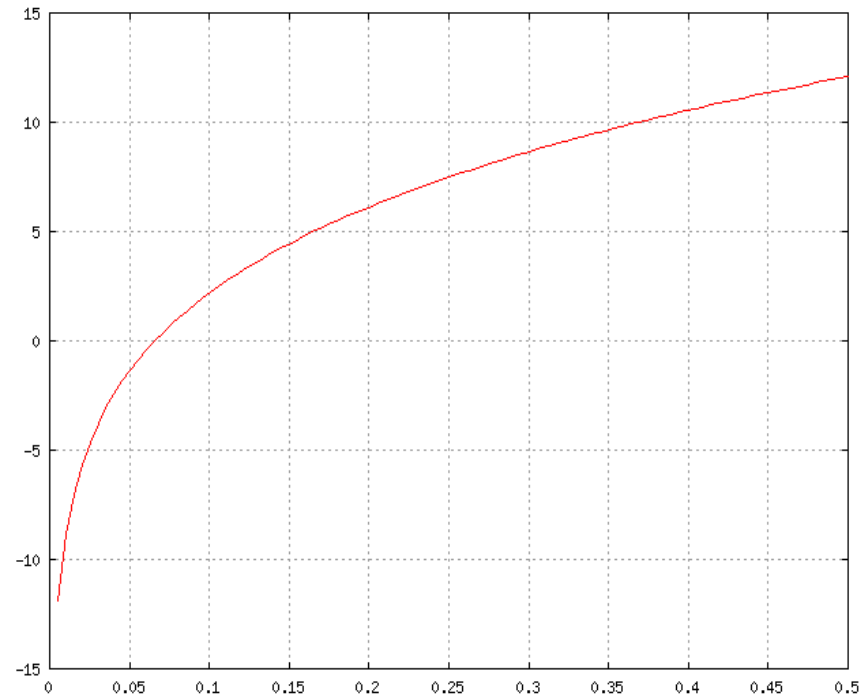

a/λ

Comparison with measured gains

Circular parabolic reflector antenna:

Size 146λ , G_{measured} : 50.4 dBi, G_{max} : 53.3 dBi

Pyramidal horn antenna:

Size 7.5λ , G_{measured} : 24.5 dBi, G_{max} : 27.7 dBi

Narda horn antenna:

Size 2.5λ , G_{measured} : 15-16 dBi, G_{max} : 18.7 dBi

Rolled slot antenna:

Size 0.2λ , G_{measured} : -11.7 dBi, G_{max} : 2.6 dBi

Slot-Dipole antenna:

Size 0.2λ , G_{measured} : 0 dBi, G_{max} : 2.6 dBi

Example : miniature loop antenna

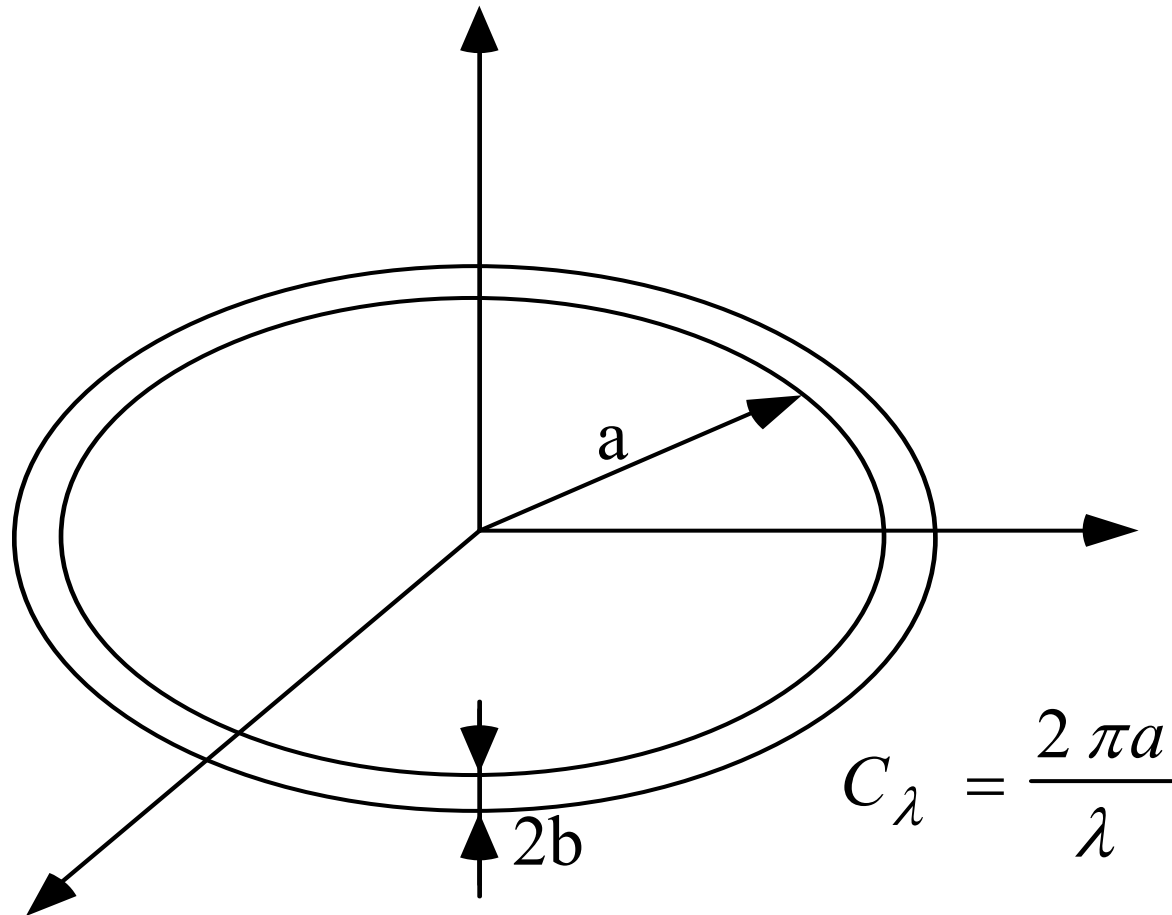

Loop antenna characteristics

small loop radiation resistance (single turn) $R_r = 20\pi^2 C_\lambda^4$

small loop radiation resistance (N turns) $R_r = 20\pi^2 C_\lambda^4 N^2$

small loop ohmic loss resistance (single turn)

$$R_{loss} = \frac{a}{b} \sqrt{\frac{\omega \mu_0}{2 \sigma}}$$

small loop ohmic loss resistance (N turns)

$$R_{loss} = \frac{Na}{b} \sqrt{\frac{\omega \mu_0}{2 \sigma}}$$

radiation efficiency

$$\eta = \frac{R_r}{R_r + R_{loss}}$$

single turn loop resistance

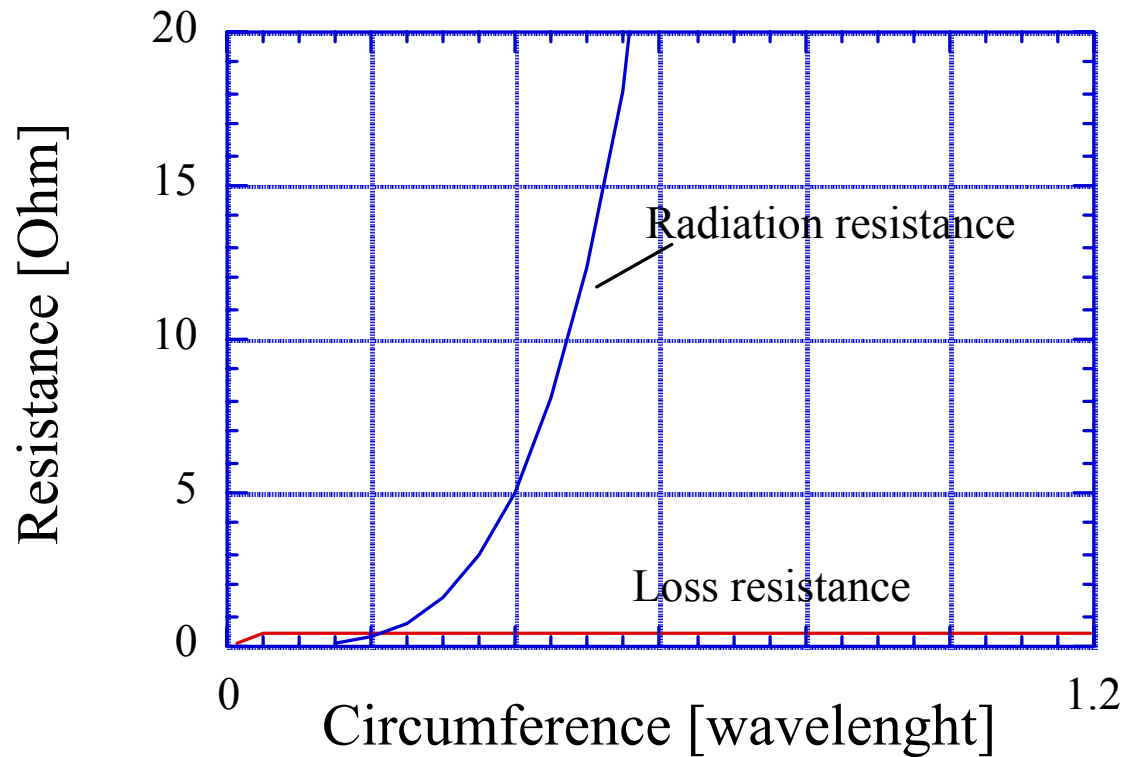

Loop made of 1 mm thick wire at 3 GHz

single turn loop resistance

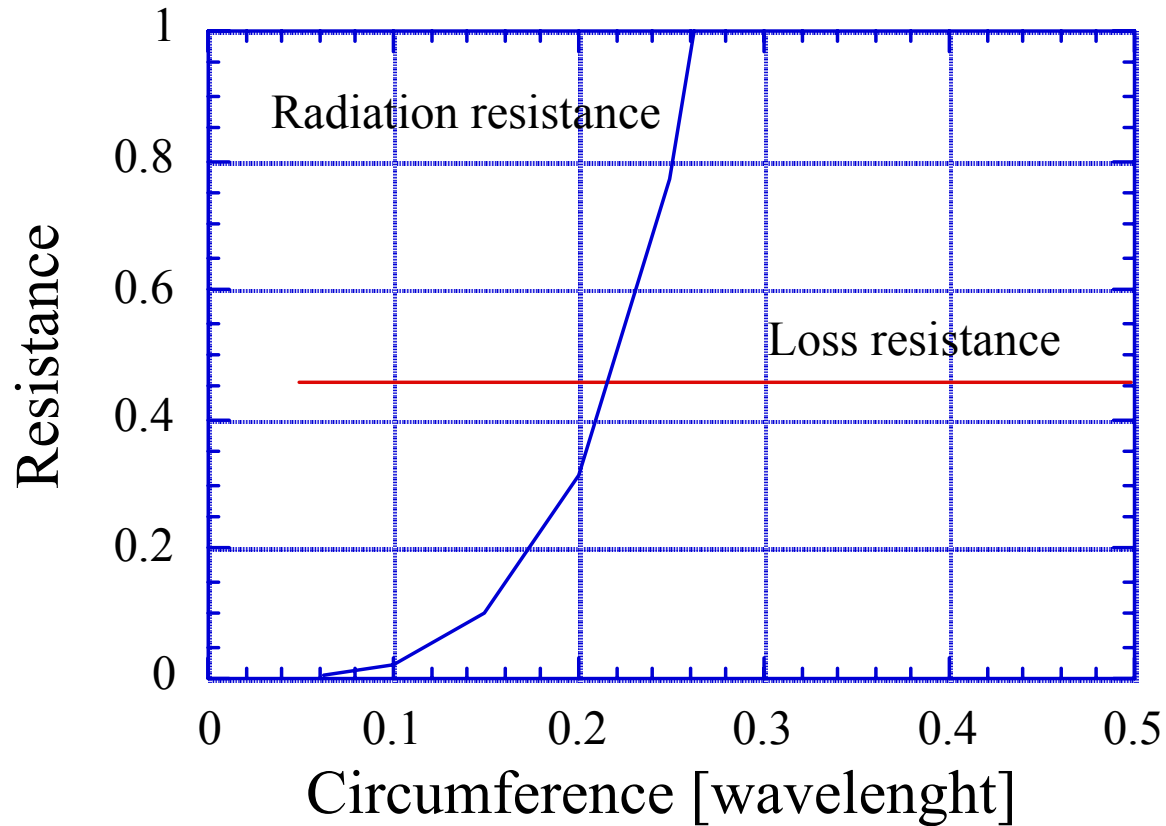

Loop made of 1 mm thick wire at 3 GHz

single turn loop efficiency

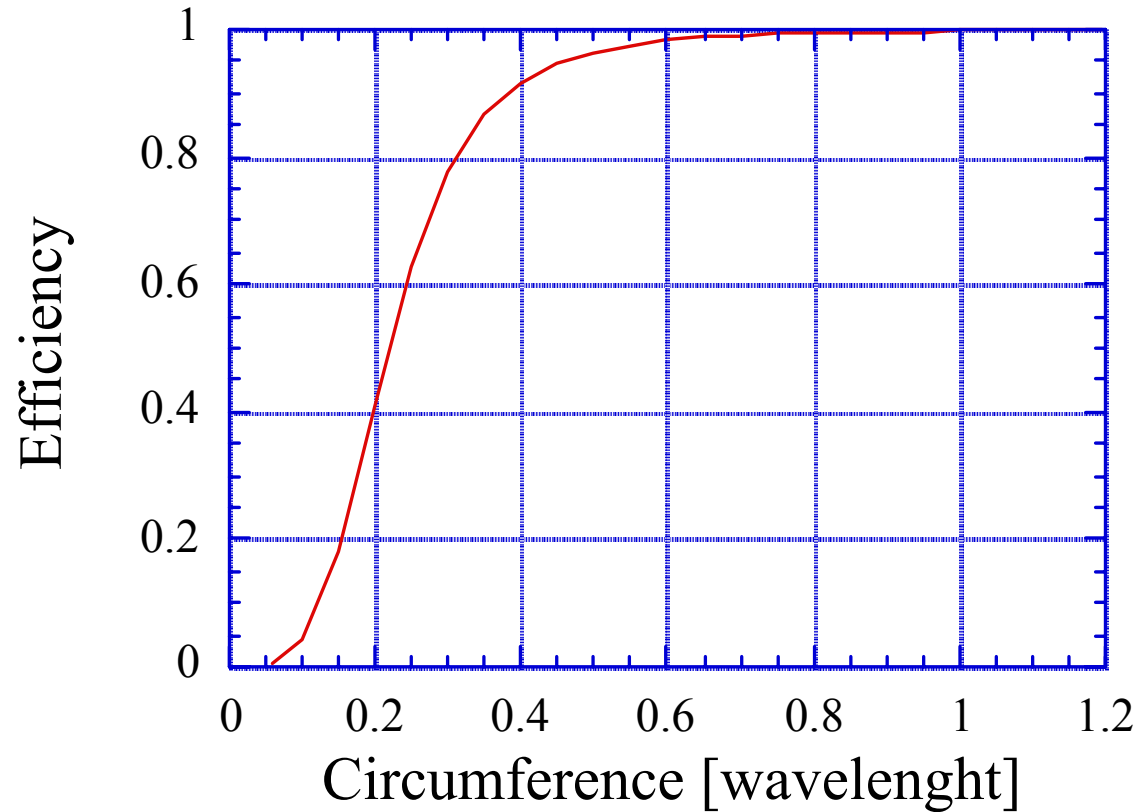

Small loop bandwidth

Single turn loop inductance :
$$L = \mu_0 a \left[\ln \frac{8a}{b} - 1.75 \right]$$

N turn loop inductance :
$$L \cong \mu_0 a \left[\ln \frac{8a}{b} - 1.75 \right] N^2$$

Loop antenna relative bandwidth :
$$\frac{\Delta f}{f_0} = \frac{R_r + R_{loss}}{2 \pi f_0 L}$$

Small loop bandwidth

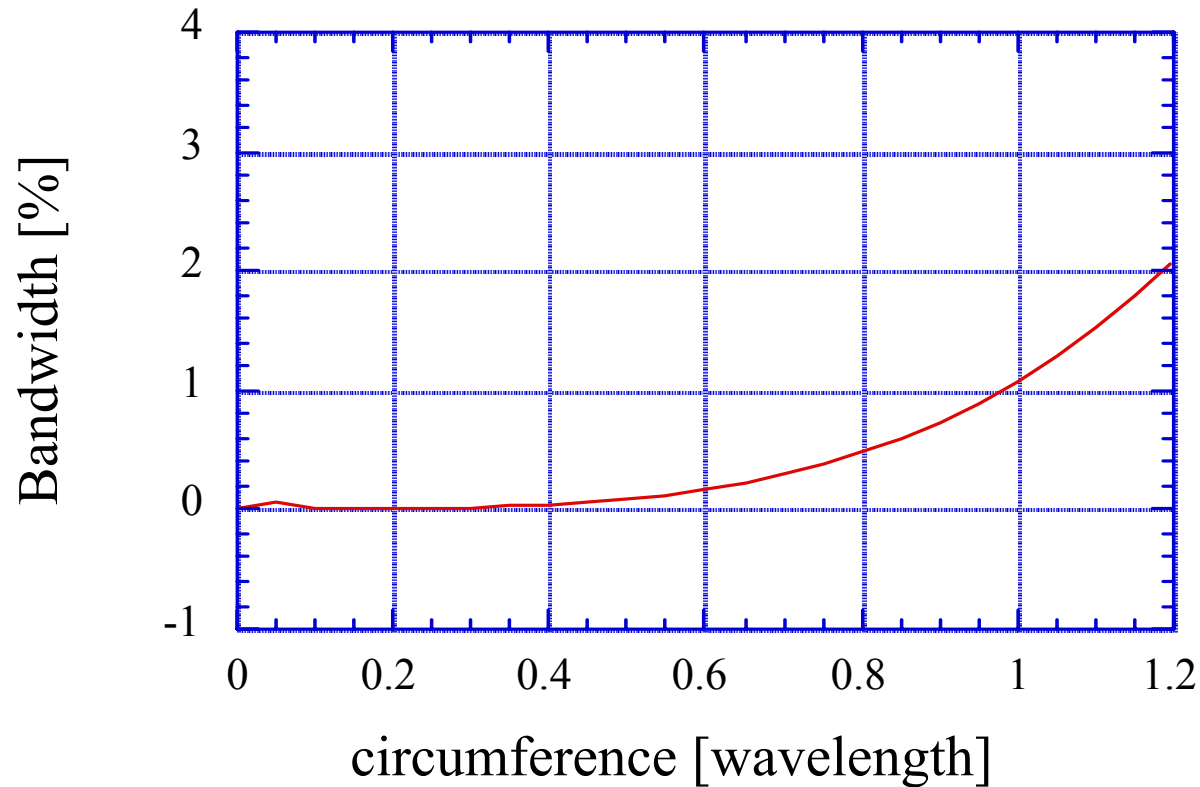

Loop made of 1 mm thick wire at 3 GHz

Example : microstrip patch antenna

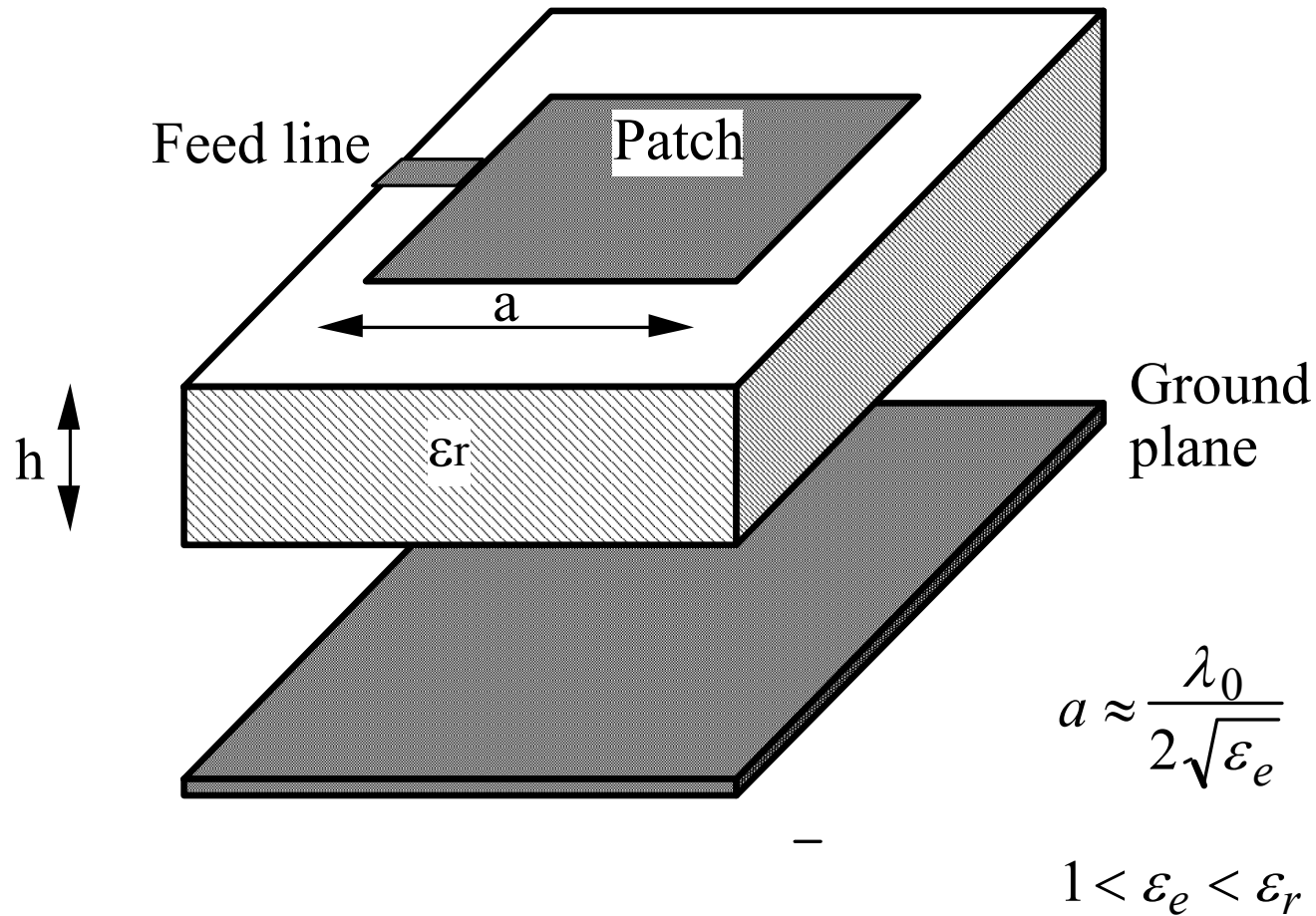

Microstrip patch miniaturization

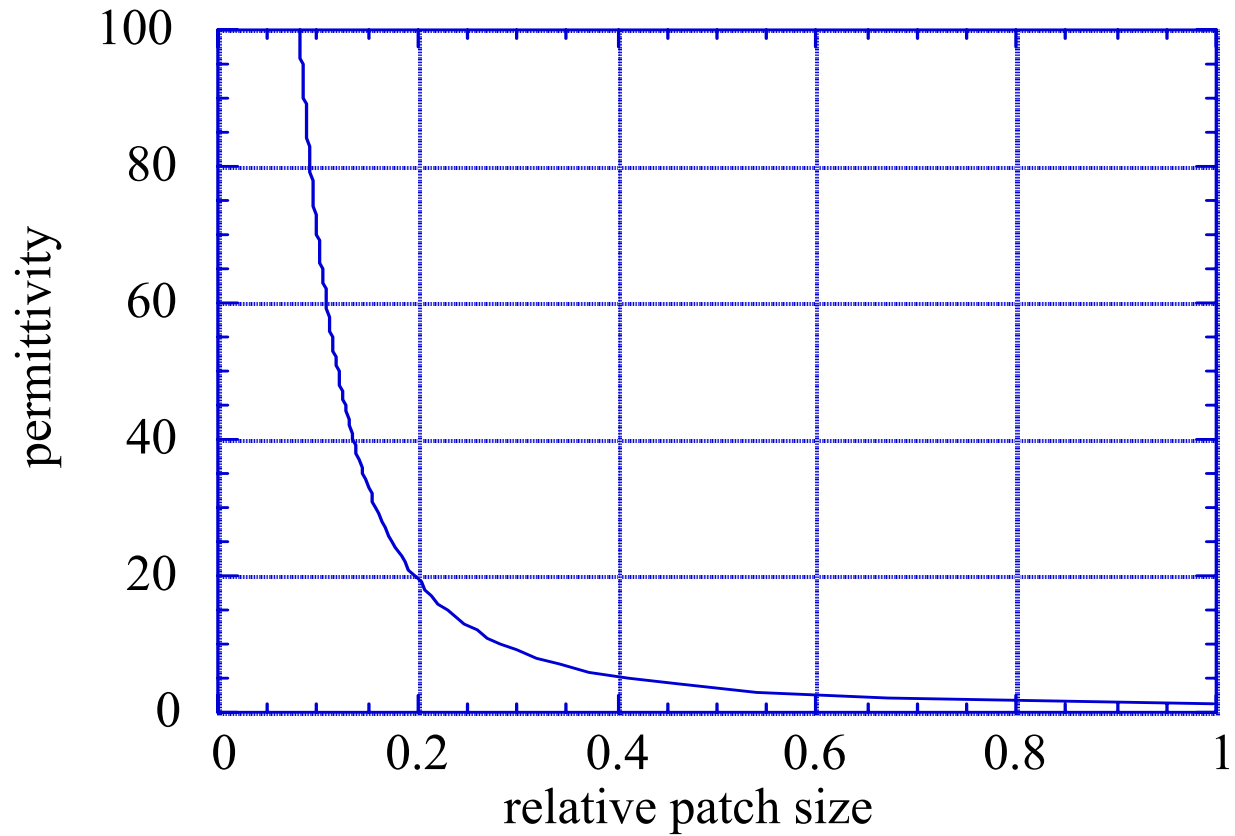

Miniature patch efficiency

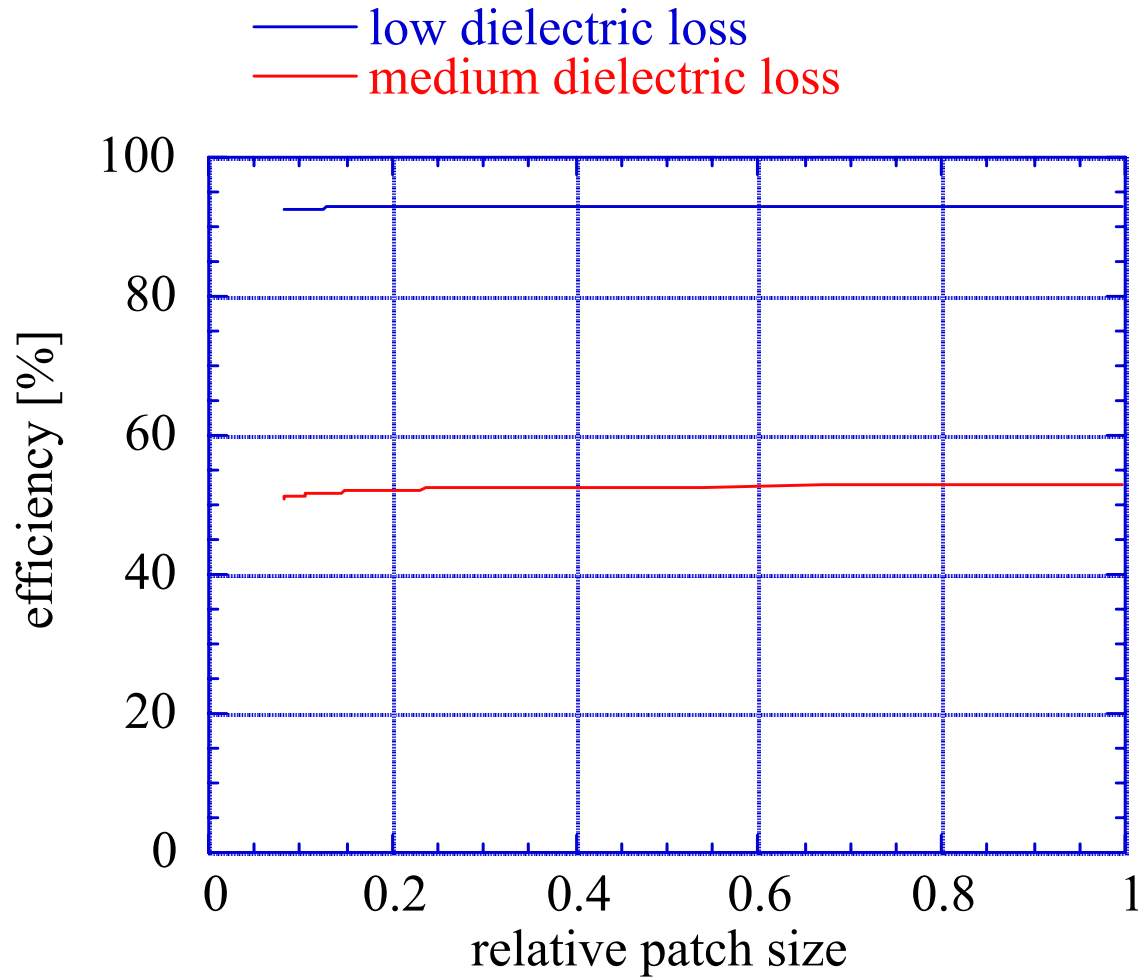

Miniature patch bandwidth

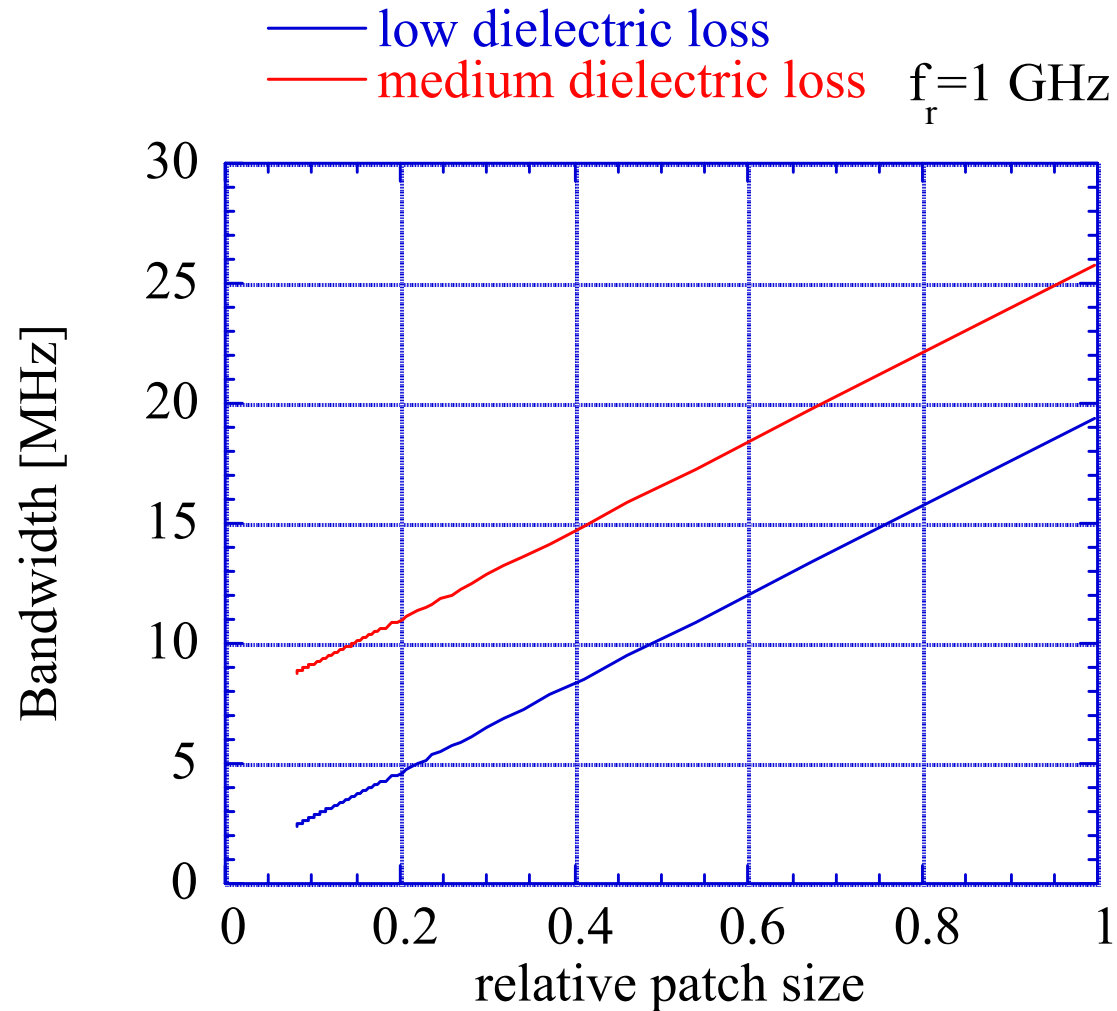

Main miniaturization techniques. Effect on the performances

- Antenna loading
 - With lumped elements
 - With high permittivity or high permeability materials
- Make some parts of the antenna virtual
 - Using ground planes
 - Using short circuits
- Optimizing the geometry
- Use the environment
- Multifrequency antennas

Antenna loading (lumped elements)

- antennas small compared to the wavelength are non-resonant (strong reactive part of the input impedance)
- antennas small compared to the wavelength usually have a small radiation resistance
- \Rightarrow small antennas can be made resonant by reactively loading them
- \Rightarrow a matching network will usually be necessary to match the radiation resistance to the transmission line

Antenna loading (lumped elements)

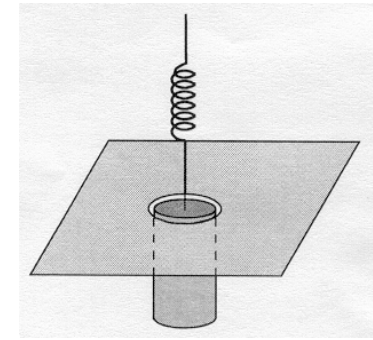
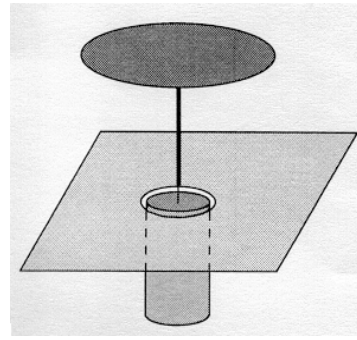
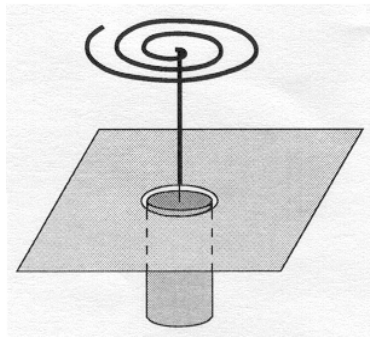
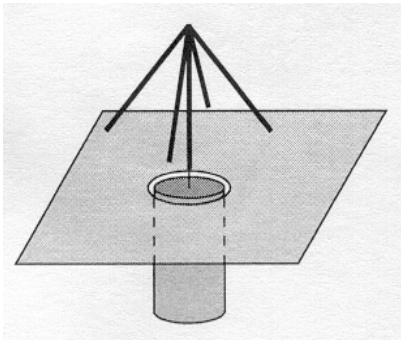
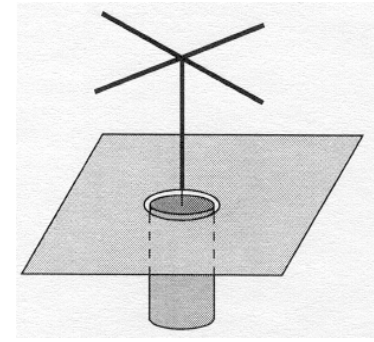
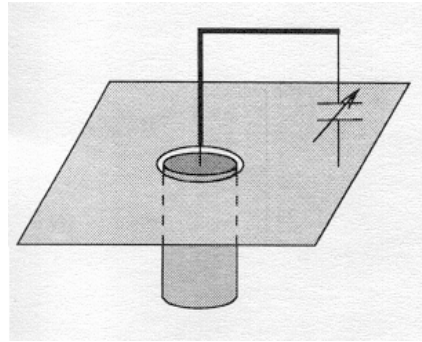
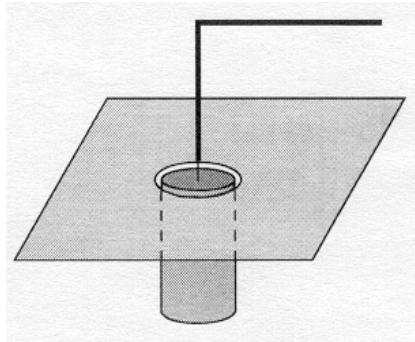
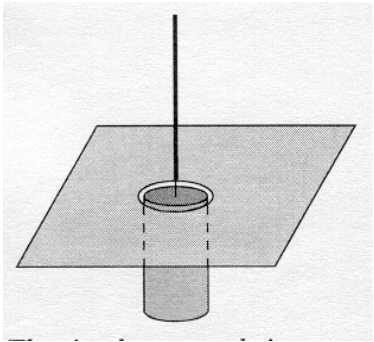

Antenna loading (lumped elements)

Effect on performances

- Lowers the antenna efficiency
 - If the added element has losses
- Enhances the antenna quality factor (lowers the bandwidth)
 - If the added element is lossless

Antenna loading (material)

- an antenna is resonant when at least one of its dimensions is of the size of half a wavelength
- the wavelength at a given frequency depends on the dielectric and magnetic properties of the material surrounding an antenna :

$$\lambda = \frac{\lambda_0}{\sqrt{\epsilon_r \mu_r}}$$

- the size of a resonant antenna can be decreased by increasing the dielectric or magnetic constant around the antenna

Antenna loading (material)

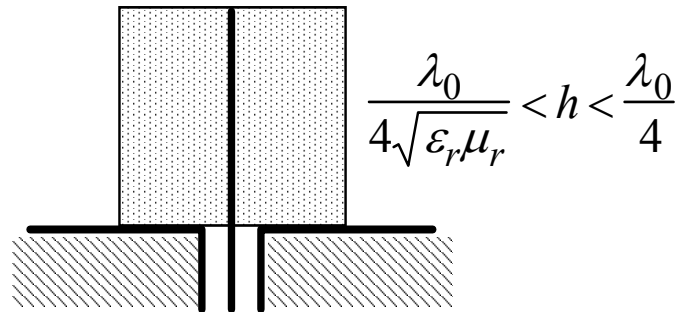
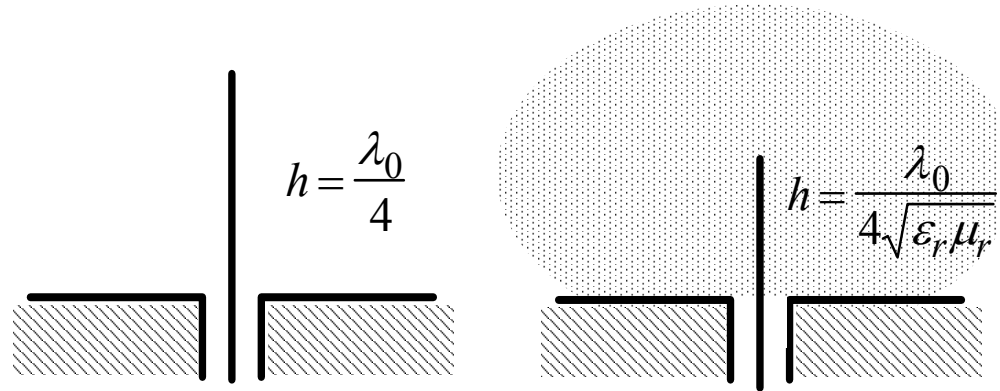

Antenna loading (material)

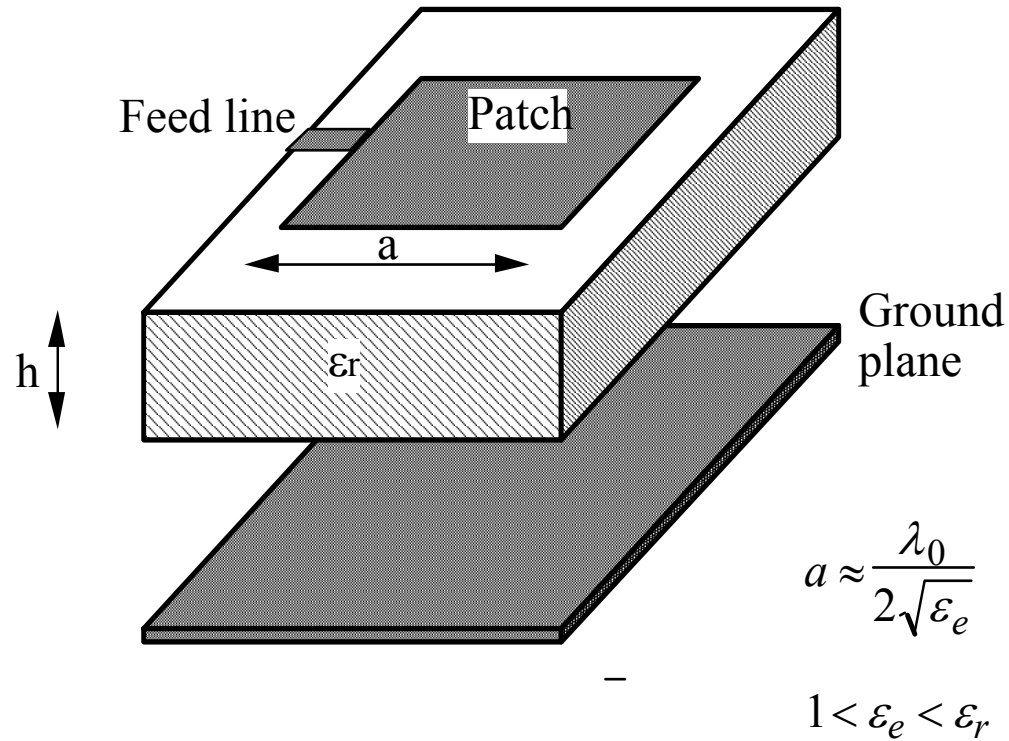

Antenna loading : Effect on performances

- Concentration of electric (magnetic) fields in the high permittivity (permeability) regions



- Higher near fields



- Higher Q and lower bandwidth

Using ground planes and short circuits

- The image theory is used to simulate currents and charges



- size reduction

Using ground planes and short circuits

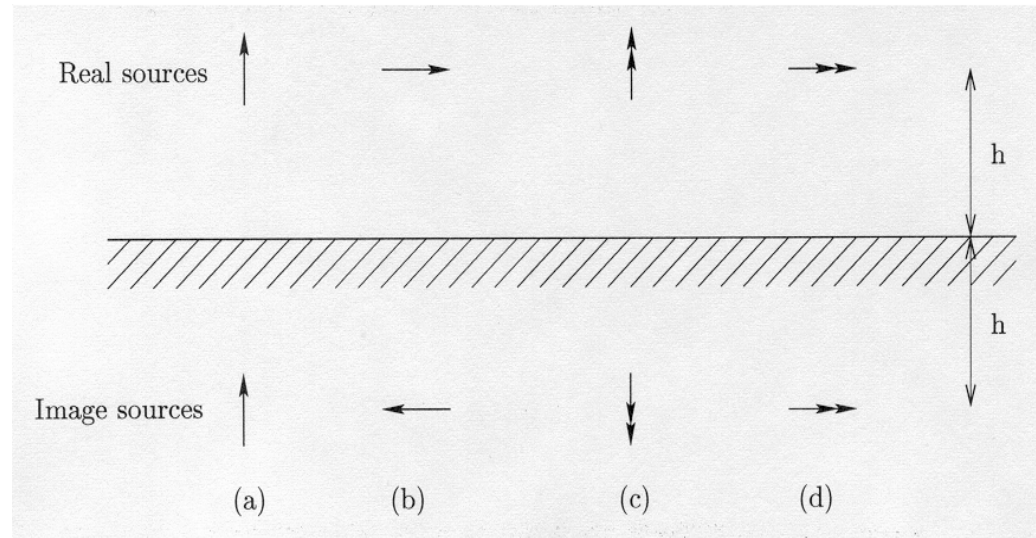

Using ground planes and short circuits examples

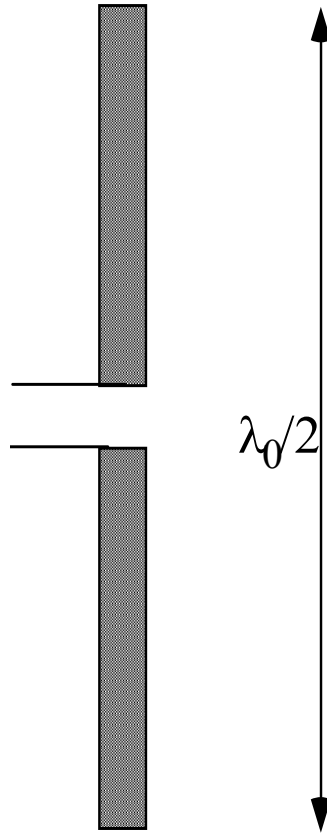

dipole

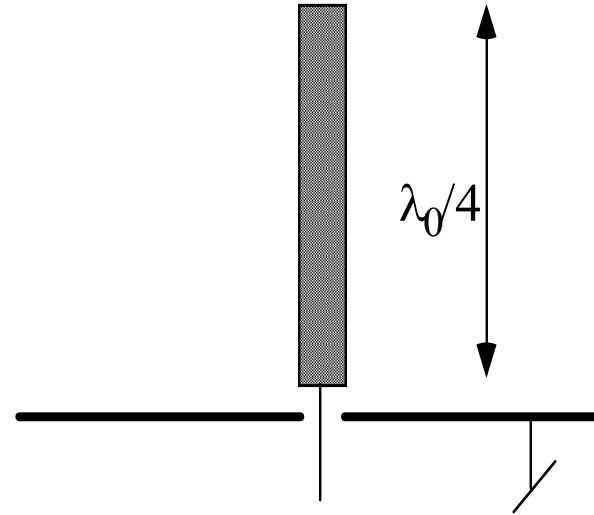

monopole

Using ground planes and short circuits examples

The Planar Inverted F Antenna

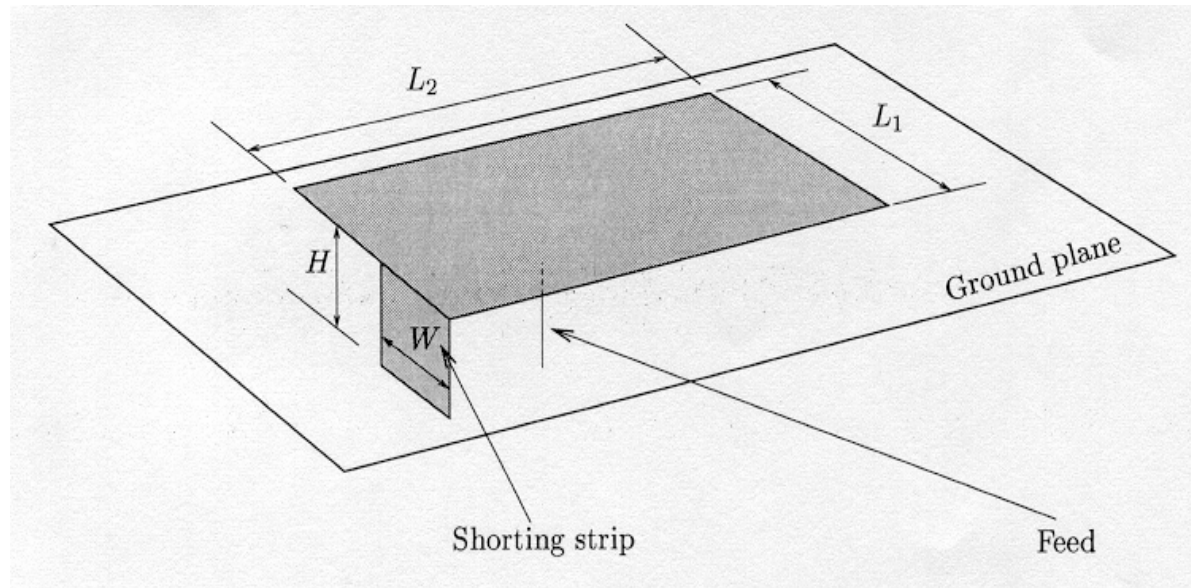

Using ground planes and short circuits effects on performances

Difficult to predict in general !

Optimizing the geometry

- geometrical loading effects (notches, slots, ...)
- bends and curvature effects

Bend effect

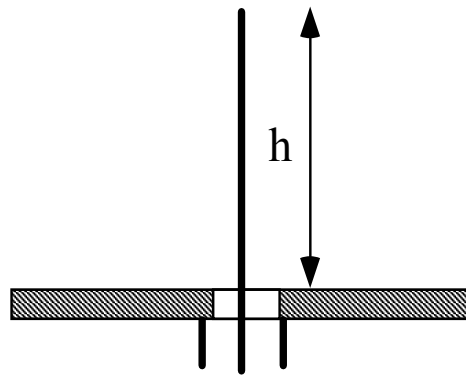

$$h \approx \frac{\lambda_0}{4}$$

monopole antenna

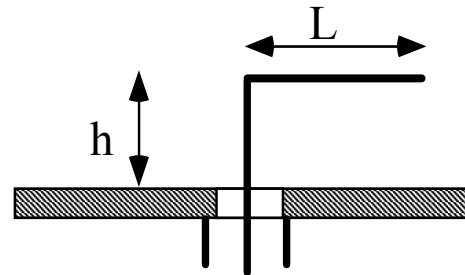

$$h + L \approx \frac{\lambda_0}{4}$$

Inverted L Antenna (ILA)

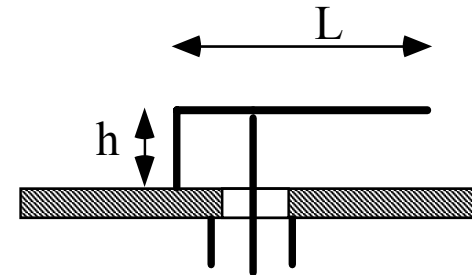

Inverted F Antenna (IFA)

Curvature effect

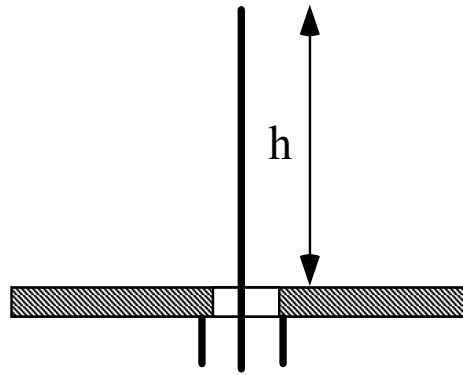

$$h \cong \frac{\lambda_0}{4}$$

monopole antenna

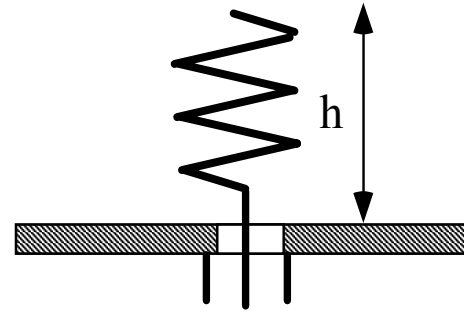

$$h < \frac{\lambda_0}{4}$$

short helix antenna

Slot effect

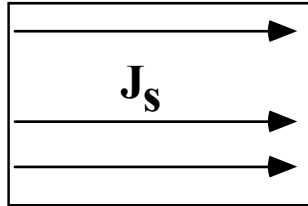
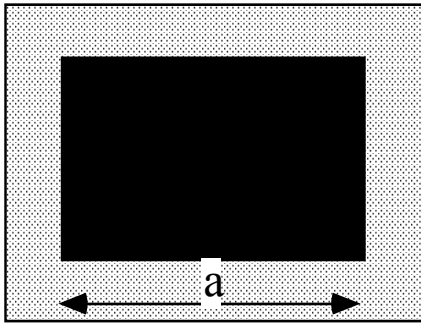

$$a \cong \frac{\lambda_g}{2}$$

microstrip antenna

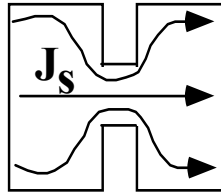
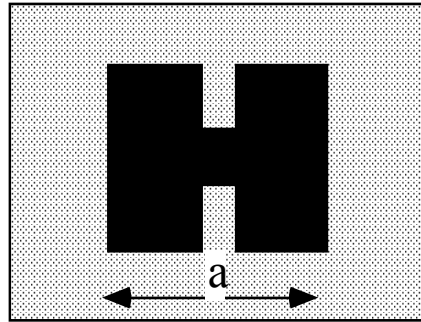

$$a < \frac{\lambda_g}{2}$$

microstrip antenna
with notches

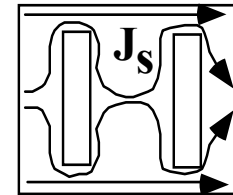
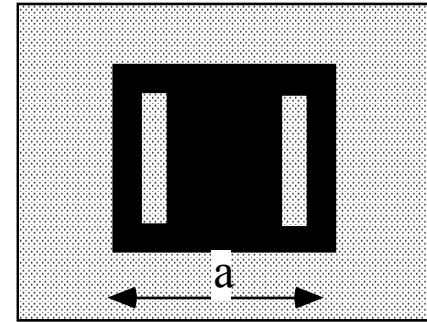

$$a < \frac{\lambda_g}{2}$$

microstrip antennas
with slots

Optimizing the geometry effect on performances

- Loss of efficiency due to current concentration
- Loss of bandwidth due to frequency sensitivity of the technique itself (image theory)
- Alteration of polarization

Using the environment

- effect of the handset case
 - use the metallic parts of the case in a constructive way
 - use the **maximum** available volume
- effect of the human body
 - the human body acts as a ground plane

example

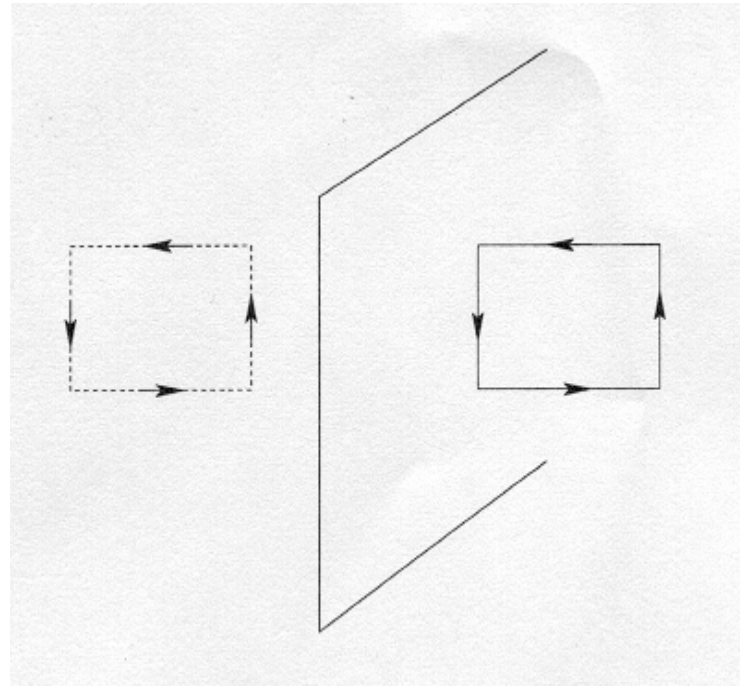
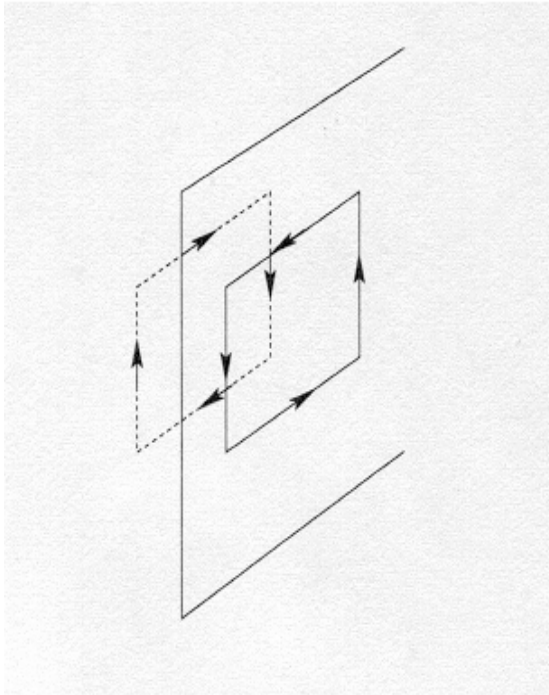

Summary

- There are physical limitations on antenna performances related to size of the antenna
- The limits are difficult to reach !
- Different miniaturization strategies have different impact on the performances. => use at least two strategies simultaneously

Design strategy

- Do a quick check of feasibility, taking into account :
 - the link budget
 - the available volume and its shape
 - the theoretical fundamental limits
 - the antenna family selected
- Perform an initial design
- Optimize

Antennas families

- Loops
- Dipole family
 - dipole
 - monopole
 - ILA
 - IFA
 - short helix
- Patch family
 - patch
 - shorted patch
 - PIFA
- Slots

Examples of antennas in wristwatches

- GPS antenna
- Bluetooth antenna

GPS in a wristwatch

- Constraints :
 - $f = 1.5754$ GHz
 - circular polarization
 - gain > -6 dBi
 - max possible gain : 3.64 dBi
- Selected solution :
 - patch under the watch hands
 - use relative high dielectric
 - use thermally compensated dielectric substrate
 - use slots to reduce patch size

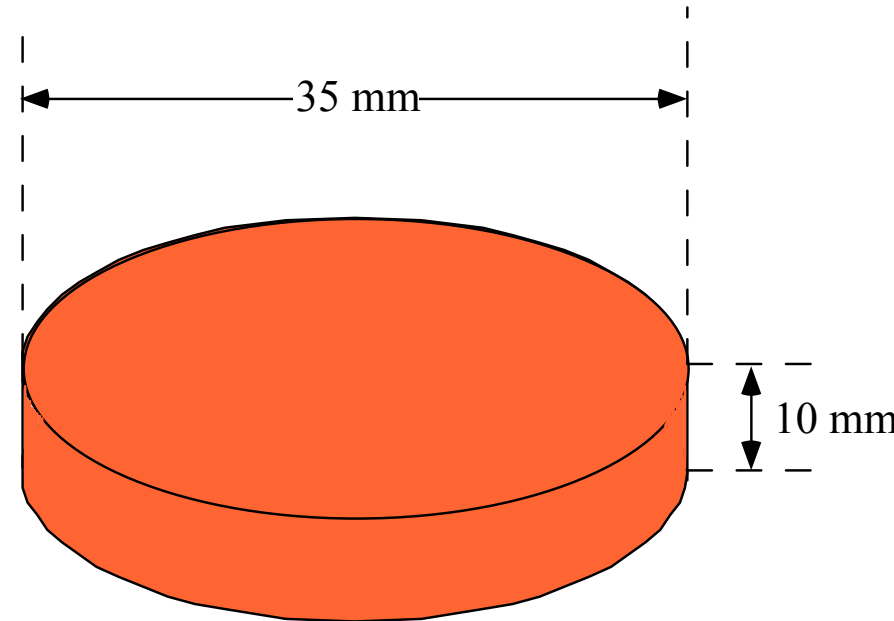

Available volume

GPS in a wristwatch

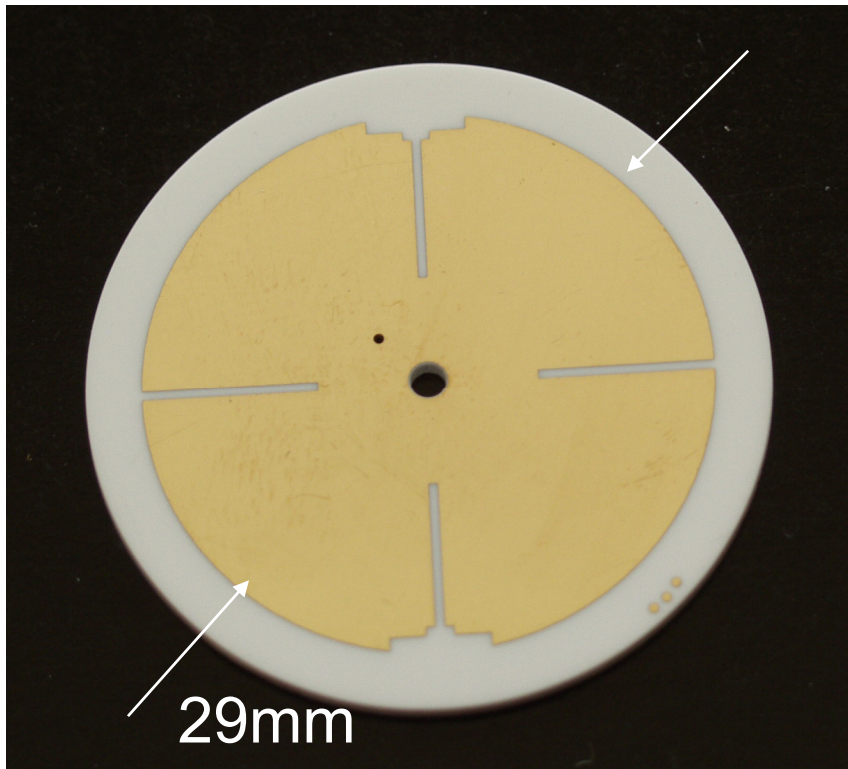

- Miniaturization
 - - Slots (80 MHz/mm)
 - - Substrate
- $BW = 0.6\%$
 - - $\epsilon_r = 9.8 \pm 0.245$
 - - The frequency must be tuned
- Gain estimated at -5 dBi

GPS in a wristwatch

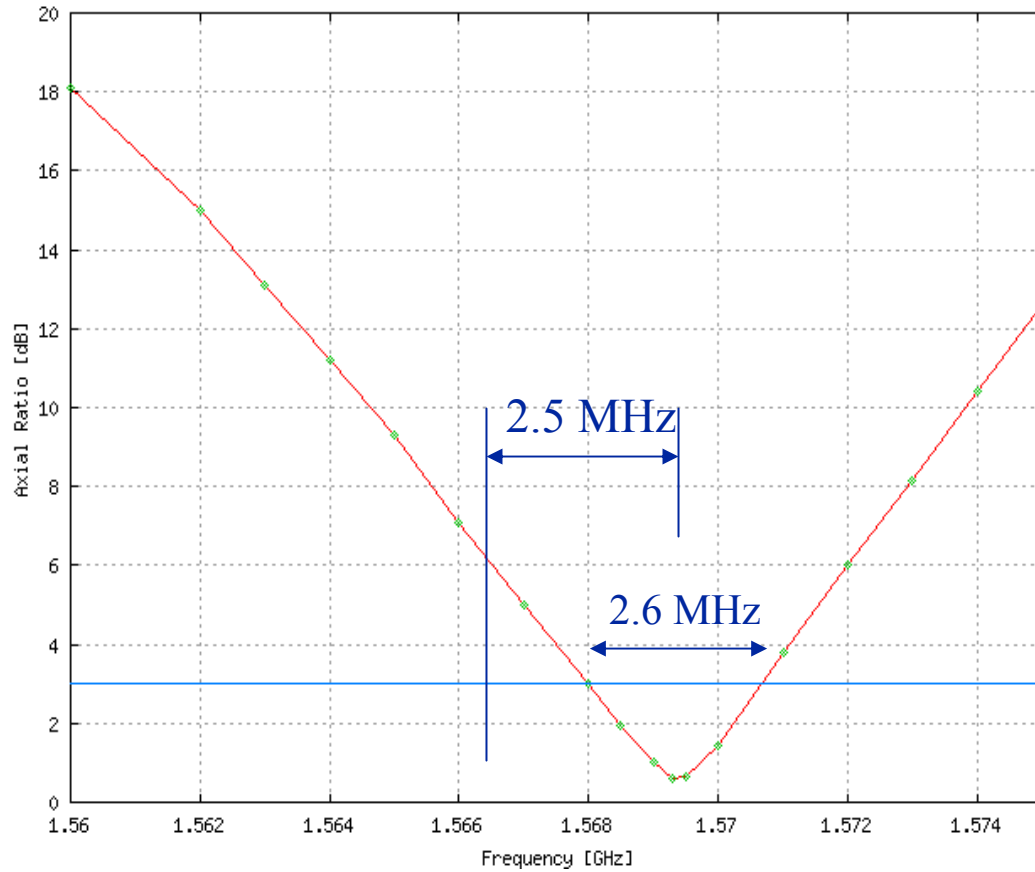

- AR=0.4 dB
- BW=0.16%

Bluetooth antenna

Constraints :

- $f = 2.48 \text{ GHz}$
- requested bandwidth : 5 %
- circular polarization
- gain as high as possible
- max possible gain : 6.8 dBi

Selected solution :

- start from a PIFA antenna
- conform it around the antenna
- minimize impact of watch bearer

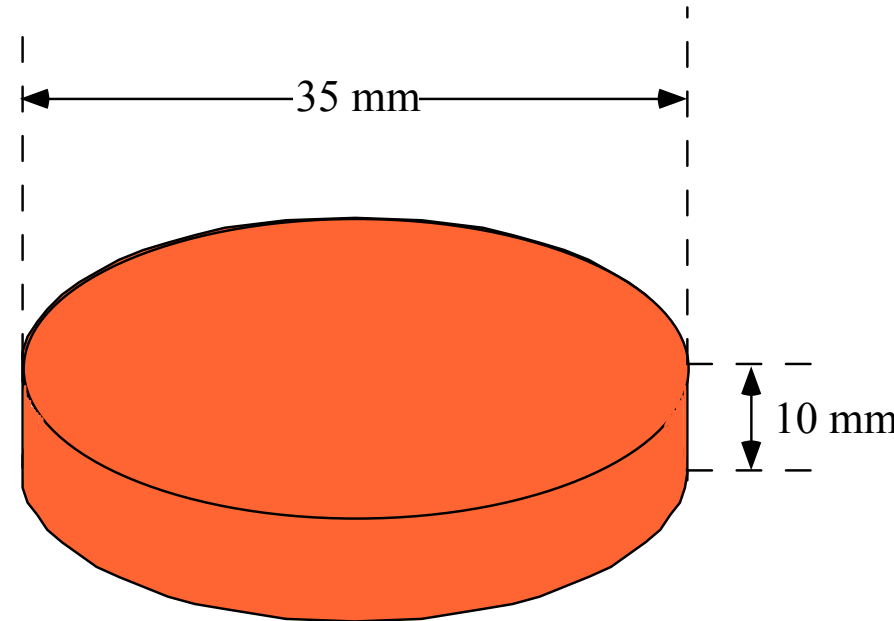

Available volume

Bluetooth antenna

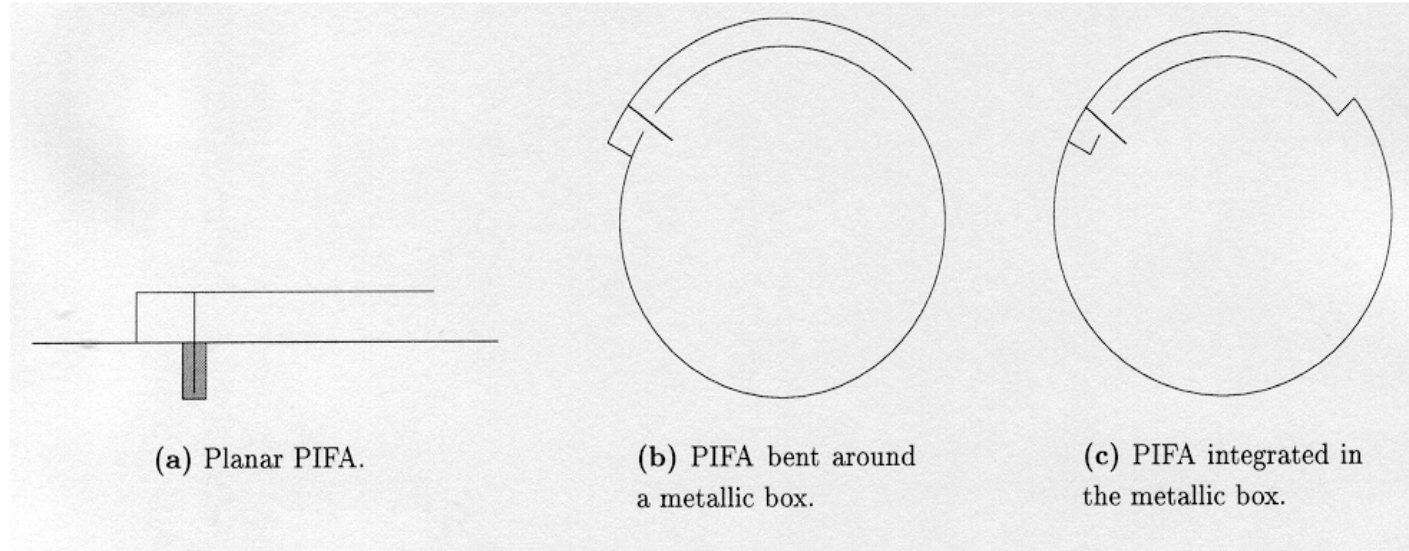

Radius = 1.75 cm ($\lambda/7$)

Height = 10 mm ($\lambda/12$)

Gap = 3 mm ($\lambda/40$)

Measured results:

Bandwidth : 4%

Gain : 0.5 dBi

Bluetooth antenna

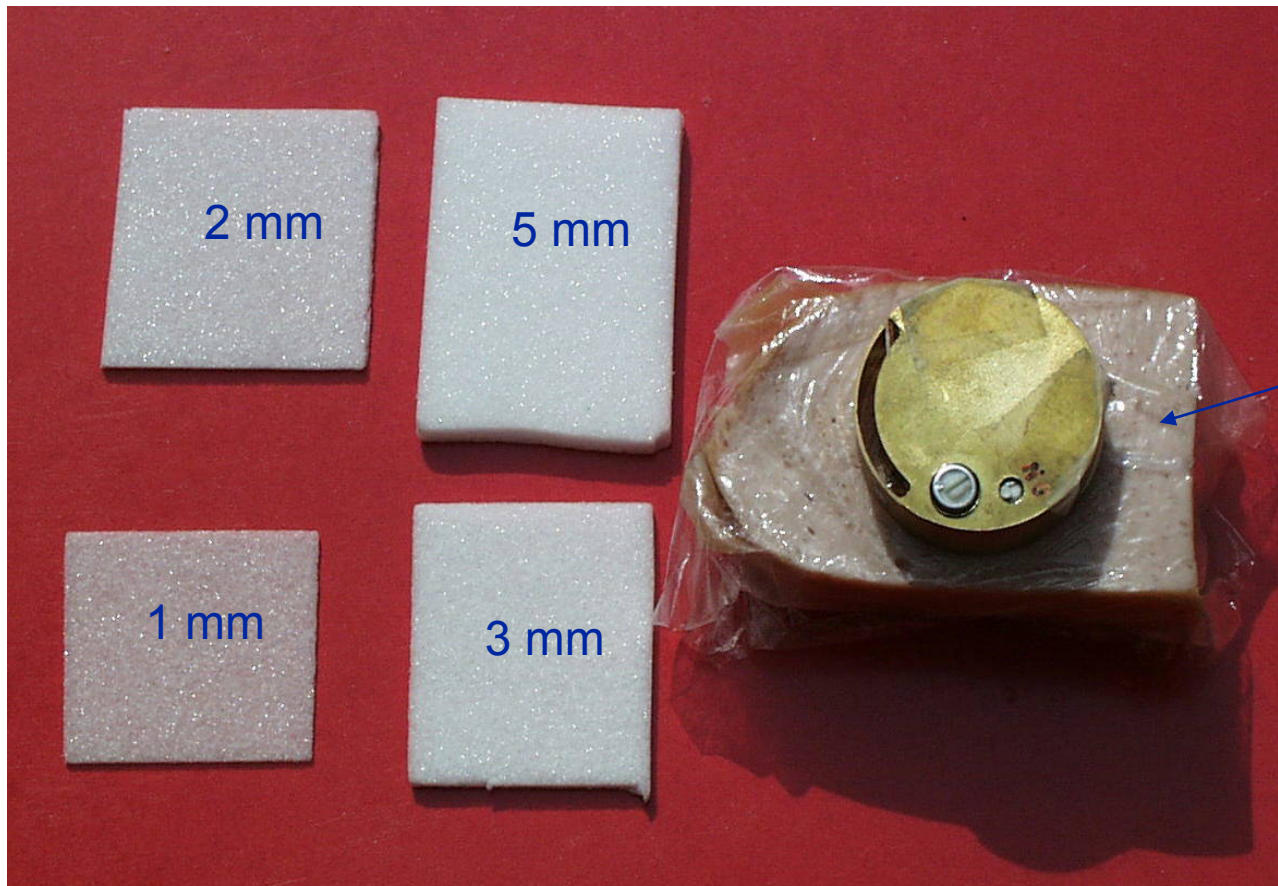

Plastic film

Bluetooth antenna

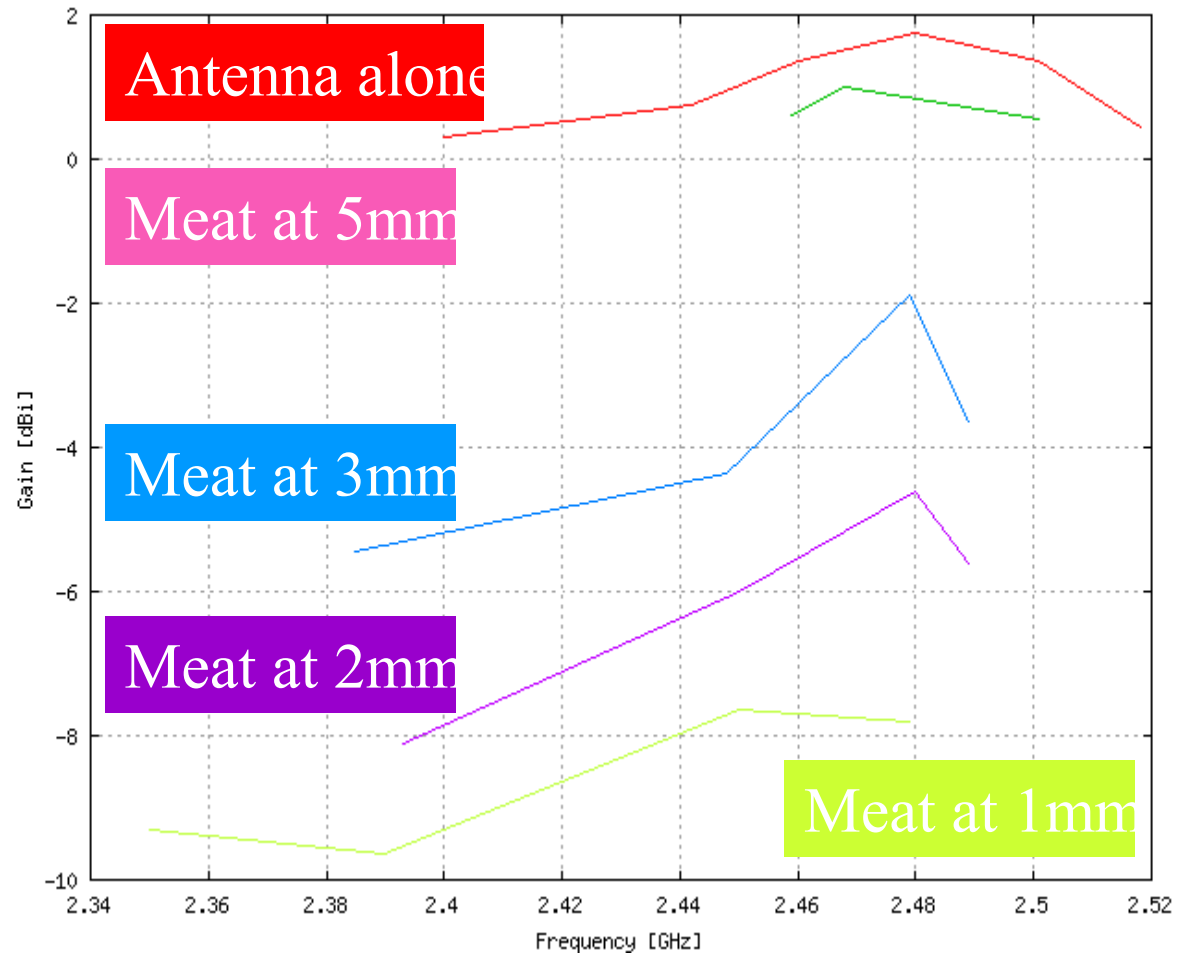

Bluetooth antenna

Second design : conformed integrated PIFA on the top

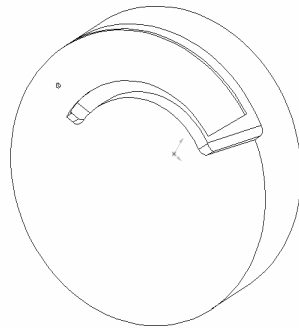
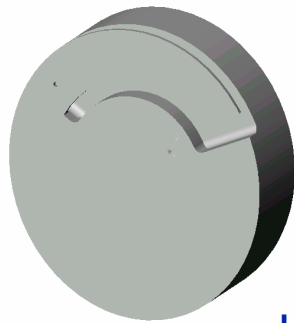

H=4 mm

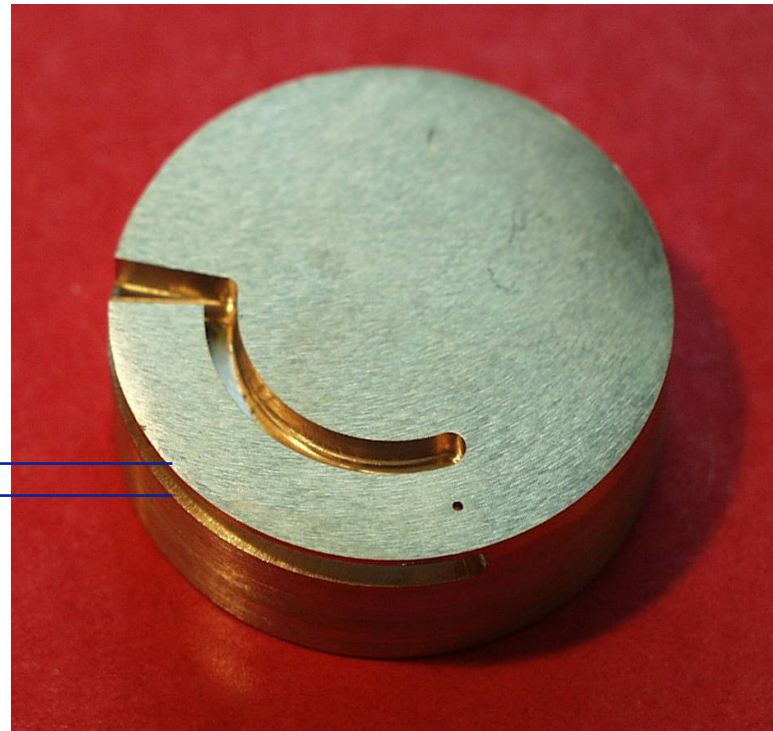
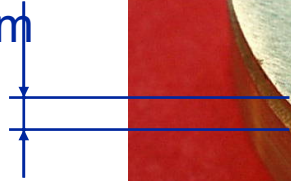

Bluetooth antenna

- the frequency of peak gain
2.415 GHz
- Peak gain : 1.29 dBi
- Variations within Bluetooth
bandwidth : 2 dB

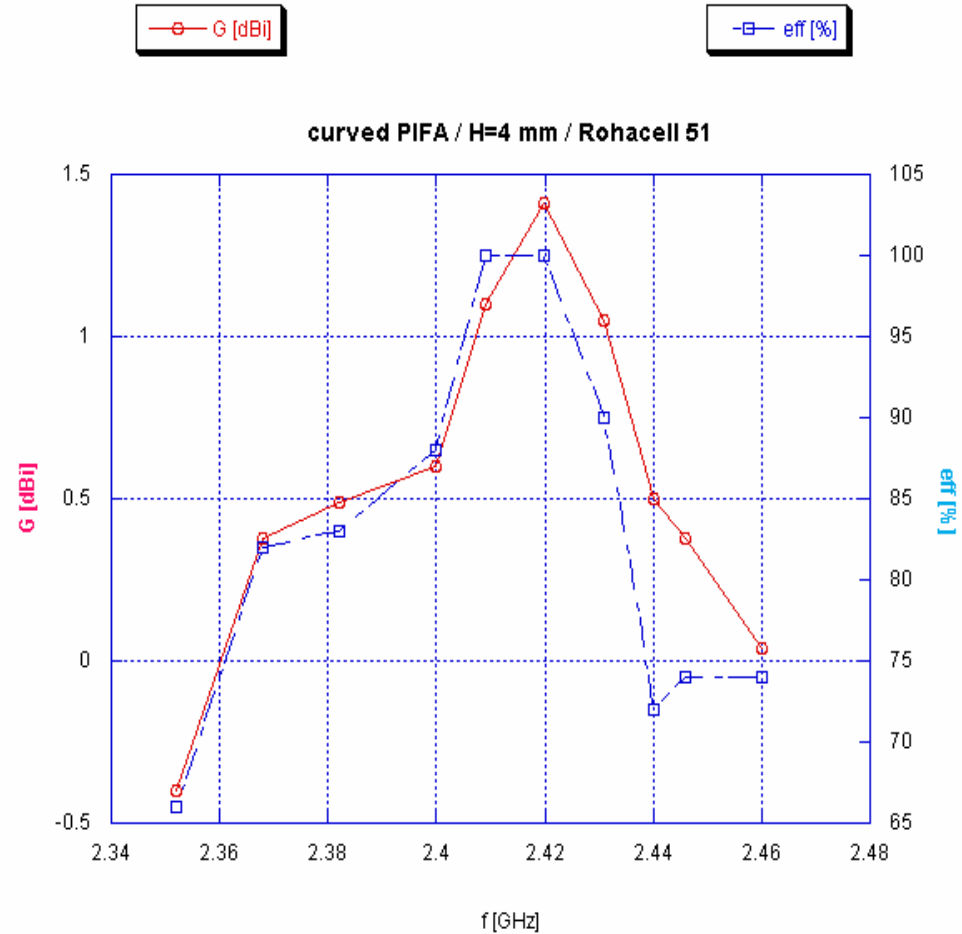

Bluetooth antenna

Effect of
"human arm"

plastic film
("Saran")



Bluetooth antenna

placed on an "arm":

- the frequency of peak gain decreases slightly (2.433 => 2.423 GHz)
- the average gain decreases (1.85 => -0.36 dBi peak gain)
- the efficiency decreases (100% => 76%)

The presence of the "arm" degrades the performance of the antenna by absorbing some of the radiated power

The curved PIFA is much less sensitive to the arm than the SMILA studied before !

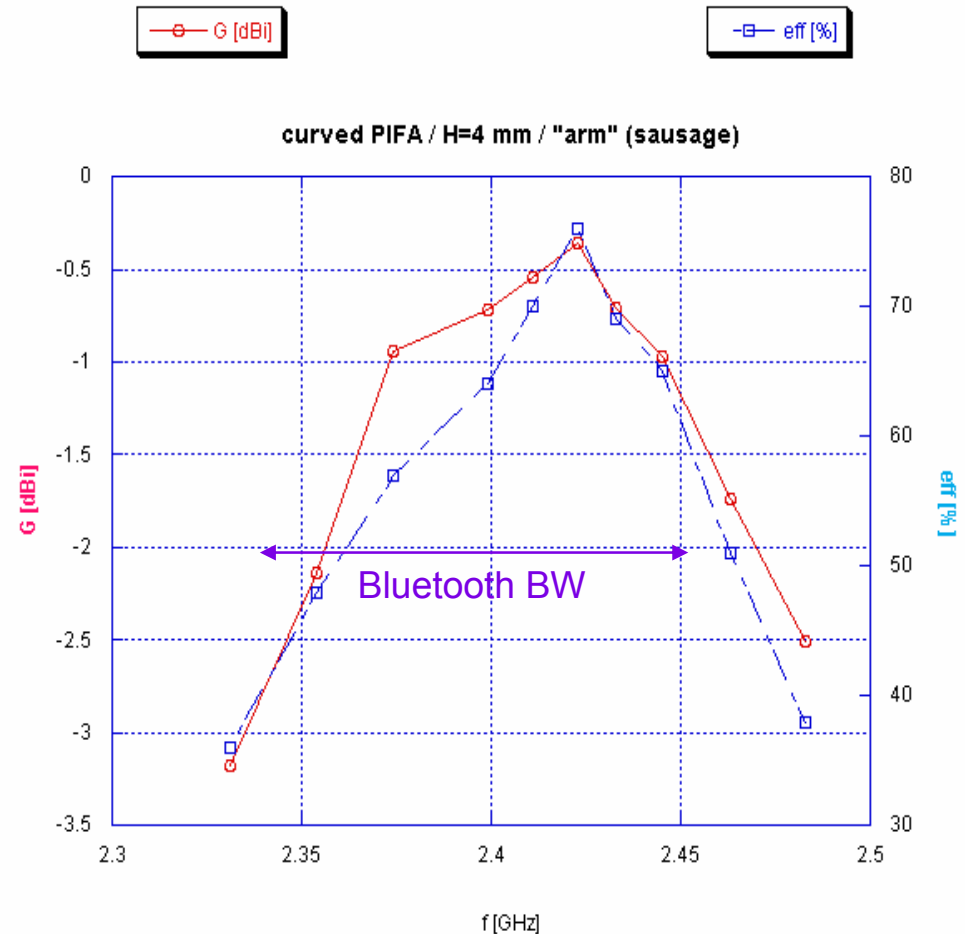

Summary

- The limitations on antenna performances are fundamental. You have to live with them
- Design strategies are an art of compromise
- Fast CAD tools do indeed help
- Intelligent optimization will help

The fun stuff for antenna engineers is still to do !

