

Evaluation of Marine VHF Radios: Performance in the Savannah, Ga. and New Orleans, La. Port Areas

**Robert L. Sole
Brent Bedford**



**U.S. DEPARTMENT OF COMMERCE
William Daley, Secretary**

Larry Irving, Assistant Secretary
for Communications and Information

April 1999

This Page Intentionally Left Blank

This Page Intentionally Left Blank

EXECUTIVE SUMMARY

The maritime mobile frequency band supports maritime communications worldwide. Appendix 18 of the ITU Radio Regulations (RR) defines the channels of the maritime mobile service. These channels support a variety of communication functions including: public correspondence, intership, ship-to-coast, coast-to-ship, port operations, calling and various safety purposes. Safety functions include distress, search and rescue, ship movement, navigation (bridge-to-bridge) communications, and maritime safety information broadcasts.

Mariners in the United States and other countries are experiencing interference on channels allocated to the above functions. The Radio Technical Commission for Maritime Services (RTCM) established Special Committee 117 to investigate the interference and determine if the International Electrotechnical (IEC) standard 1097-7 “*Global Maritime Distress and Safety System (GMDSS)-Part 7: Shipborne VHF Radiotelephone Transmitter and Receiver-Operational and Performance Requirements, Methods of Testing and Required Test Results*” would be sufficient to protect marine VHF radios from interference. In support of this effort, NTIA, in coordination with the Coast Guard and RTCM SC-117, undertook a task to perform tests on commercial and recreational grade marine VHF radios to the IEC standard and perform radiated tests in areas where severe cases of interference are occurring. Laboratory testing of the radios to the IEC standard was performed in Boulder, Colorado. The radiated tests were performed in Savannah, Georgia on the Savannah River and on the Mississippi River in New Orleans, Louisiana. Mariners in both locations have been reporting cases of severe interference in the marine VHF band on the waterways for quite some time now. Some of the channels experiencing the interference are key channels used for safety and bridge-to-bridge communications. The interference is very disruptive to normal operations on the river and is distracting to the radio operators.

The IEC tests and radiated tests were based on receiver SINAD measurements. In the IEC 1097-7 test procedures, the SINAD of a receiver being tested was set to 20 dB by adjusting the desired signal power and then injecting interference into the circuit to reduce the SINAD to 14 dB. The resulting interference-to-signal ratio (I/S) was then calculated in dB and compared to the minimum IEC requirement. In the IEC tests, the interference was simulated using signal generators. The IEC tests simulated adjacent and co-channel interference, receiver saturation (blocking), and intermodulation interference. The radiated tests used emitters that were present in the electromagnetic environment of the test area to degrade the SINAD. The radiated testing revealed that emitters in the environment were causing receiver saturation and intermodulation/cross modulation interference in the radio receivers.

Spectrum recordings were taken during the radiated tests when the SINAD measurements were 14 dB or less. These recordings were used to identify the sources of interference in Savannah and New Orleans. The recordings seem to indicate that the interference is due to NOAA weather broadcasts and land mobile transmitters (*1997 Code of Federal Regulations*, Parts 90 and 22 Title 47) operating within and around the marine VHF band. The antennas of the weather broadcast and land mobile transmitters are located very close to the river’s edge in both locations and transmit at higher power levels than the mobile marine VHF radios. Both of these factors contribute to the severity of the interference. However, it should be noted that the land mobile transmitters are operating in compliance with respect to the FCC rules and regulations for output power, frequency tolerance, and spurious emissions. The NOAA VHF weather broadcasts also seem to be operating properly.

Because they are operating in compliance with the FCC rules and regulations, it would be difficult to impose any operating restrictions on land mobile systems operators. Therefore practical solutions to solve this problem would be to continue the development of receiver standards through RTCM SC-117, encourage mariners to use radios that are more resistant to interference, and develop antenna siting guidelines for future deployment of weather broadcast and land mobile transmitters to reduce interference.

TABLE of CONTENTS

Section 1. Introduction	
1.1 Background	1-1
1.2 Test Objectives	1-2
1.3 Test Radios	1-2
Section 2. Test Results	
2.1 Savannah, Georgia Tests	2-1
2.2 New Orleans, Louisiana Tests	2-6
Section 3. Interference Coupling Mechanisms	3-1
3.1 Blocking and Receiver Front-end Overload/Saturation	3-1
3.2 Intermodulation and/or Cross-modulation	3-2
3.2 RTCM Receiver Standard	3-3
Section 4 Evaluation of Radio Performance.....	4-1
Section 5. Conclusions and Recommendations	5 -1
Appendix A: Radiated Test Procedures	A-1
Appendix B: Savannah SINAD Histograms	B-1
Appendix C: New Orleans SINAD Histograms	C-1

This Page Intentionally Left Blank

This Page Intentionally Left Blank

SECTION 1

INTRODUCTION

1.1 Background

NTIA published a report for the Coast Guard that studied the compatibility between 12.5 kHz and 25 kHz channelized marine VHF radios, NTIA TR-97-343 “*Assessment of Compatibility between 25 and 12.5 kHz Channelized Marine Radios.*” One of the conclusions of the report was that the adoption of appropriate standards for marine VHF radio receivers would help alleviate problems due to congestion in the marine electromagnetic environment. Currently, the United States does not have receiver standards for marine VHF radios. An organization comprised of mariners, radio manufacturers, and frequency regulators, the Radio Technical Commission for Maritime services (RTCM), established RTCMSC-117 to investigate receiver standards developed by other regulatory agencies or organizations. One organization, the International Electrotechnical Commission (IEC), has recently published a document that contains proposed standards for marine VHF radios.

The IEC standards for marine radios are in a document titled “*IEC 1097-7: Global Maritime Distress and Safety System (GMDSS)-Part 7: Shipborne VHF Radiotelephone Transmitter and Receiver-Operational and Performance Requirements, Methods of Testing and Required Test Results*”.

In support of this effort, NTIA, in coordination with the Coast Guard and RTCMSC-117, undertook a task to perform tests on commercial and recreational grade marine VHF radios to the IEC standard and perform radiated tests in areas where severe cases of interference are occurring. This task was accomplished by testing marine VHF radios in a laboratory to the IEC 1097-7 standard and then testing those same radios in marine environments where mariners have reported severe cases of interference. Savannah, Georgia and New Orleans, Louisiana were chosen as locations for “live” testing due to the numerous complaints from mariners that their communications are being disrupted on the Savannah and Mississippi Rivers due to interference in the marine VHF band.

The IEC procedures and standards are based on receiver SINAD measurements and signal-to-interference (S/I) ratios. A receiver SINAD measurement is the ratio, expressed in dB, of the desired signal power to interference, noise, and distortion. The methodology of the IEC laboratory tests was to measure the receiver SINAD with interference injected into the radio along with the desired signal. Each test had a minimum performance objective for the SINAD and signal-to-interference (S/I) ratio in the presence of interfering signals. The laboratory tests used signal generators as interference sources to degrade the receiver SINAD measurements. The tests performed in Savannah and New Orleans used emitters that were present in the electromagnetic environment to degrade the receiver SINAD measurement. This report documents the results of performing SINAD tests on marine VHF radios in the Savannah, Georgia and New Orleans, Louisiana port areas and how the results relate to the laboratory tests. This report also attempts to identify the interference coupling mechanisms and ways to mitigate their effects. The results of the laboratory tests conducted to the IEC 1097 standard, which contains the recorded data for each radio tested are published in NTIA Report 99-363.

1.2 Test Objectives

The objectives of these tests were to:

- ! Measure the SINAD of marine radios operating in a shipboard environment at Savannah, Georgia and New Orleans, Louisiana.
- ! Determine the severity of the interference in relation to the IEC 1097 standard.
- ! Attempt to identify the sources of interference and the interference mechanisms.
- ! Investigate ways to mitigate and preclude the interference.

1.3 Test Radios

Commercially available analog 25 kHz channelized marine VHF FM radios were tested. These 25 kHz radios included four commercial grade radios representative of the type used by commercial boaters and government agencies.

Most recreational boaters use less expensive 25 kHz radios that retail for under 300 dollars. These types of radios, which were found to be more susceptible to interference, were also tested. NTIA purchased three fixed mount and two hand-held radios of these types from local retailers for testing.

The radios are identified by alphabetical code. Manufacturers' names and model numbers are not included in this report. The radios are categorized as either recreational or commercial grade radios and as either fixed-mount or handheld below in Table 1-2.

Table 1-2
Radio Description

Radio	Type	Grade
A	fixed-mount 25 kHz	recreational
B	fixed-mount 25 kHz	commercial
E	hand-held 25 kHz	recreational
F	fixed-mount 25 kHz	commercial
G	hand-held 25 kHz	recreational
H	fixed-mount 25 kHz	recreational
I	fixed-mount 25 kHz	recreational

K	fixed-mount 25 kHz	recreational
L	fixed-mount 25 kHz	commercial
M	fixed-mount 25 kHz	commercial

Radio L had a local/distance switch for its receiver accessible on a front panel control which was separate from the squelch control. Radio M had an adjustable attenuator for its receiver which was part of the squelch control. These radios were designed with these features for operations in congested EM environments.

This Page Intentionally Left Blank

This Page Intentionally Left Blank

SECTION 2 TEST RESULTS

2.1 Savannah, Georgia

The test area for Savannah is shown below in Figure 2-1. The radios were tested using the procedures outlined in Appendix A with the test set-up shown in Figure A-1.

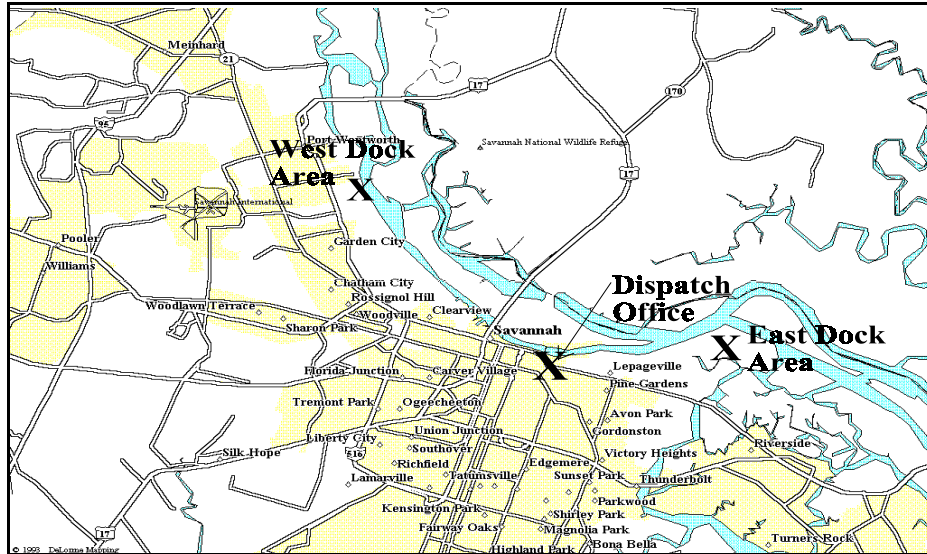

Figure 2-1
Savannah Test Area

The performance of the radios was evaluated on channel 18A (156.900 MHz) during normal tugboat operations by monitoring the test radios SINAD measurements. This channel is used by a local tugboat company as a primary communications link between their dispatch office and the tugboat fleet. The interference on this channel is very disruptive to their business operations and distracting to radio operators. Other marine channels are affected by the interference in this area as well, including channels 16 and 13. The test set-up was installed in the wheelhouse of one of the tugboats and data was collected as the tugboat traveled on the river or was stationary. The test area is identified in Figure 2-1 as the stretch of the Savannah River between the points labeled the East Dock and the West Dock. The tugboat dispatch office is also shown in Figure 2-1.

For a baseline configuration, the SINAD of the radio under was set to 20 dB by adjusting the RF power of the signal generator with a load connected into the circuit in place of the antenna (see Fig. A-1). When the load was removed and the tugboat antenna was connected into the circuit, the receiver of the radio being tested immediately experienced de-sensitization and periodic audible interference was heard in the radio receiver. The de-sensitization was observed by watching the degradation of the receiver SINAD as measured by the test set. Depending on the radio under test,

the SINAD was immediately degraded from the 20 dB starting point to approximately 2-14 dB when the tugboat antenna was connected into the circuit. The audible interference further degraded the SINAD to 0-4 and was periodic in nature.

The receiver de-sensitization was not audible in the receivers. Except for radio L operating in local mode, the periodic audible interference occurred in all radios and rendered the channel useless for communications during the period that it occurred. The duration of the audible interference events was approximately 3.5-4 seconds. Multiple consecutive events compounded the problem.

A SINAD histogram for each radio tested is shown in Appendix B. The histograms show the percent of time versus SINAD value and includes all SINAD values, not just those below 14 dB. This level is the minimum allowable SINAD value with interference present in the IEC 1097-7 test procedures. Radios that had a higher percentage of time with a greater SINAD value had better performance. This effect is shown in Figures B-1 and B-2. Figure B-1 shows the SINAD histogram for radio L in the distance mode and Figure B-2 is the same radio operating in local mode. In the distance mode, the SINAD values ranged from 1-13 dB with the major portion of the distribution in the 7-10 dB range. In the local mode the SINAD values ranged from 7-19 dB with the major portion of the distribution in the 10-15 dB range. The differences between the figures show that for the overall percentages of time, the local mode of operation measured higher SINAD values than distance mode and the radio had audibly better performance. However, for local mode operation the radio requires a minimum desired signal power of about -107 dBm versus -117 dBm for distance mode for a 20 dB SINAD.

Some of the less costly recreational grade radios were essentially “flatlined” by the desensitization and audible interference. For example, the SINAD for radio E in Figure B-9 never got above 3 dB. Other recreational grade radios never had a SINAD above 5 dB. These types of radios are used for commercial and non-commercial marine communications.

In an attempt to identify the sources of interference, a spectrum analyzer was used to sweep the 150-174 MHz band and record the power of the emitters when the SINAD of the radio under test fell below 14 dB. The receiver de-sensitization effect and the audible interference caused the SINAD to be below the trigger point so that data was collected for each type of interference event. With the exception of the hand held radios, data was collected for each radio during tugboat operations. Data was collected for the hand held radios at the tugboat office located at the river’s edge.

Since the radios were tested in the same environment and experienced the same type of interference, the spectrum record taken for an interference event for any one radio is typical for all radios tested. However, in some cases of interference events, different emitters were observed to be active at different times.

The spectrum recordings shown below in Figures 2-2, 2-3, 2-4, and 2-5 were recorded while testing radio L, tuned to channel 18A (156.9 MHz), on the tugboat. These figures only show emitters that were transmitting at that instant that this particular spectrum snapshot was taken. Other spectrum snapshots may show different emitters active at different frequencies other than those shown in Figures 2-2 to 2-5. Figure 2-2 shows a spectrum record for the 150-164 MHz band. Figures 2-3, 2-4, and 2-5 show portions of that band in greater detail to help identify individual emitters.

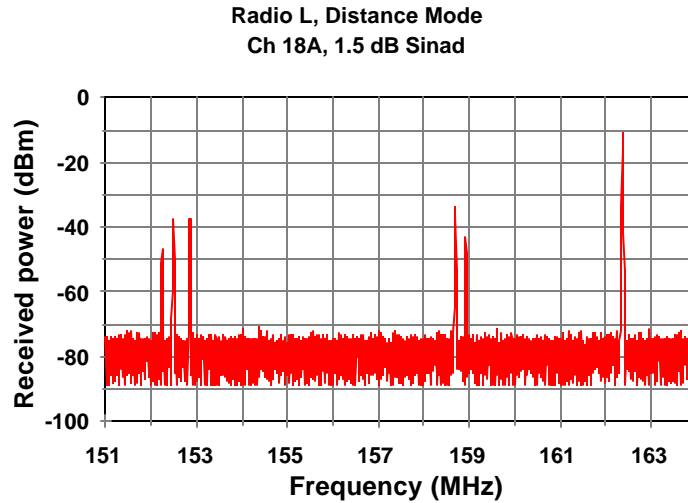

Figure 2-2
151-164 MHz Band Spectrum Record

This spectrum trace was recorded when the audible interference reduced the SINAD of receiver L to 1.5 dB. The signals shown below in Figure 2-3 are transmitters operating at the following frequencies: 152.24, 152.48, and 152.84 MHz. Their operations were periodic and peaked in the morning and evening.

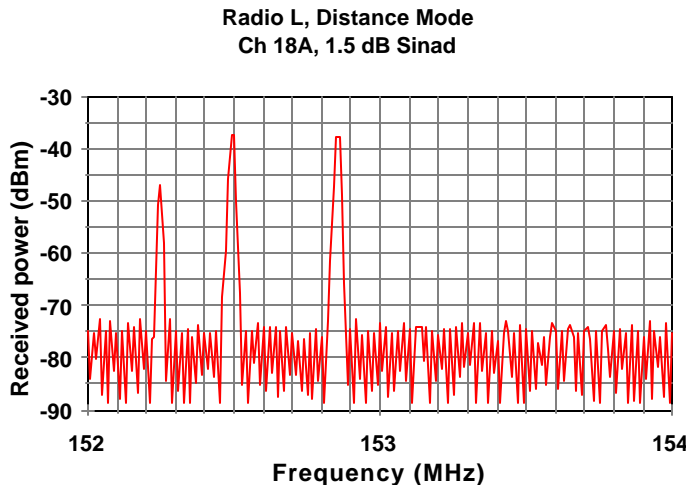

Figure 2-3
152-154 MHz Band Spectrum Record

The signals shown below in Figure 2-4 are transmitters operating at 158.7 and 158.925 MHz. Their operations were periodic and peaked in the morning and evening.

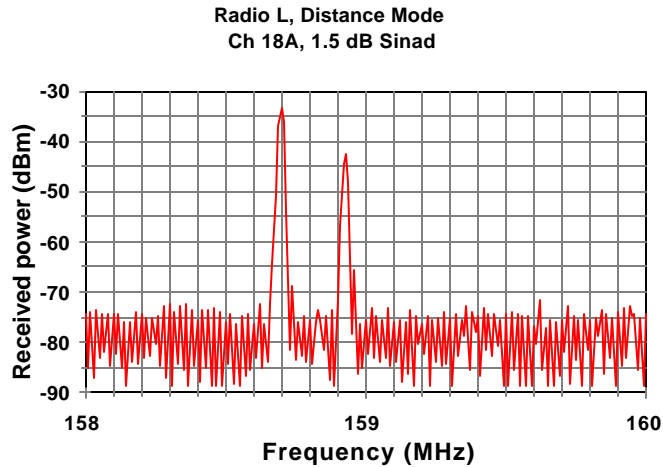

Figure 2-4
158-160 MHz Band Spectrum Record

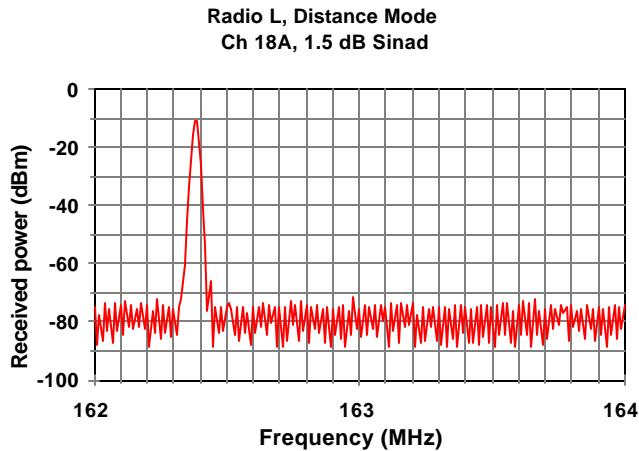

Figure 2-5
162-164 MHz Band Spectrum Record

The signal shown in Figure 2-5 is identified as a NOAA weather transmitter broadcasting at 162.4 MHz. This transmitter is also identified as WX2 in the VHF marine weather channel assignments. This transmitter was “on” at all times and not periodic like some of the emitters in the previous figures. The figure shows the received power to be approximately -10 dBm. This signal and its interference mechanism was very similar to the IEC “blocking” test, which was shown to saturate the radio receivers at such a high power level.

The land mobile transmitters identified in Figures 2-3 and 2-4 produced received power levels up to -27 dBm at the radio receiver. These power levels were shown to produce intermodulation products in some receivers in the IEC intermodulation bench test.

At the tugboat dispatch office, additional tests were performed by using RF step attenuators to decrease the interferer powers till the audible periodic interference was no longer heard in the radio receiver. This test was performed aurally and did not involve a SINAD measurement. The amount of attenuation each radio needed to effectively eliminate the audible interference is shown below in Table 2-1.

Table 2-1
Receiver Attenuation Values

Radio Receiver	Attenuation (dB)
B	10
F	10
G	20
H	10
I	30
K	20

As shown in Table 2-1, the range of attenuation needed to lower the power of the land mobile transmitters and weather channel emissions into the radio receiver to reduce the audible interference so that the 1 kHz test tone was audible ranged from 10 to 30 dB. The attenuation also reduced the sensitivity of the radio. The resolution for these tests was 10 dB. It was difficult to “hear” the change in the level of the audible interference using smaller steps of attenuation.

2.2 New Orleans, Louisiana

The test area for New Orleans is shown below in Figure 2-6. The radios were tested using the procedures outlined in Appendix A.

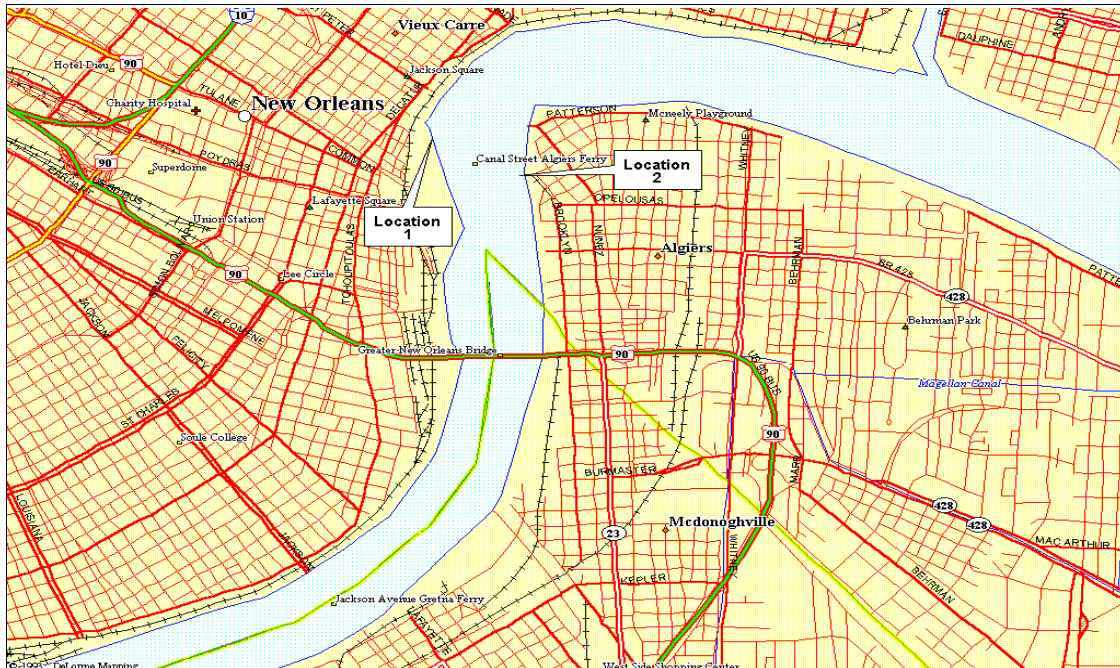

Figure 2-6
New Orleans Test Area

The SINAD performance of the radios was evaluated on marine VHF channels 25 (public correspondence receive, 161.850 MHz) and 67 (bridge-to-bridge, 156.375 MHz). The test set-up was installed in a fire boat and data was collected as the boat traveled the river or was docked. The radios were tested using channel 25 as the desired signal channel while docked at location 1 shown in Figure 2-7. The radios were tested using channel 67 as the desired signal channel while docked at location 2 shown in Figure 2-6. Channel 67 is the primary channel for bridge-to-bridge communications on the lower Mississippi River. Mariners have complained about the interference on this channel for quite some time. Interference on this channel can make communications difficult between ships on the river. The interference on channel 67 seemed to be “worst” in the river main channel. However, due to the large amount of traffic in the river channel it was not safe to loiter in the channel itself and collect data while testing multiple radios.

At both test locations, the radios experienced receiver de-sensitization and periodic audible interference was heard in the radio receiver. The de-sensitization was observed by watching the degradation of the receiver SINAD as measured by the communication test set. Depending on the radio being tested, the SINAD was reduced from the 20 dB starting point to approximately 2-15 dB when the ship’s antenna was connected into the circuit. The periodic audible interference further reduced the SINAD to approximately 1-5 dB.

The receiver de-sensitization was not audible on the receivers. Except for radio L operating in local mode and radio M with the built in attenuator set at its maximum value, the periodic audible interference occurred in all radios and rendered the channel useless for communications during that period. The duration of the audible interference events was approximately 3.5-4 seconds. Multiple consecutive events compounded the problem..

A SINAD histogram for each radio tested in New Orleans is shown in Appendix C. As shown in Savannah, radios that had a higher percentage of time with greater SINAD values had better performance. This effect is once again shown for radio L in Figures C-1 and C-2. Figure C-1 shows the SINAD histogram for radio L in distance mode and Figure C-2 is radio L in local mode operation. In distance mode the SINAD values ranged from 1-8 dB with the major portion of the distribution in the 2-4 dB range. In the local mode the SINAD values ranged from 14-19 dB with the major portion of the distribution in the 14-17 dB range. The differences between the figures show that for the overall percentages of time, the local mode of operation measured higher SINAD values than distance mode and the radio had audibly better performance. As in the case of Savannah, the SINAD measurements of the recreational grade radios in New Orleans was in the 0-5 dB range and the 1 kHz test tone was inaudible due to the interference.

A spectrum analyzer was used to sweep 150-174 MHz band and record the power of the emitters when the SINAD of the radio under test was 14 dB or less. These spectrum recordings showed that the EM environment of New Orleans was denser than Savannah with more emitters present. The receiver de-sensitization effect and the audible interference caused the SINAD to be below the trigger point so that data was collected for each type of interference event. The dense EM environment made it difficult to identify specific emitters during the audible interference.

Sample spectrum plots are shown below in Figures 2-7 to 2-9 They were taken during the testing of radio L at location one. These plots are representative of the EM environment at that instant that this particular SINAD measurement was taken. They should not be considered to be indicative for all cases of interference events.

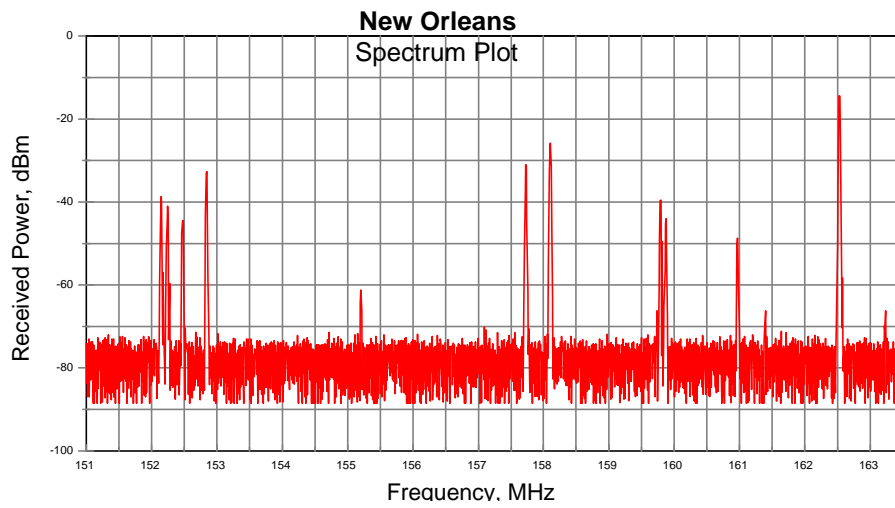

Figure 2-7
151-163.5 MHz Band

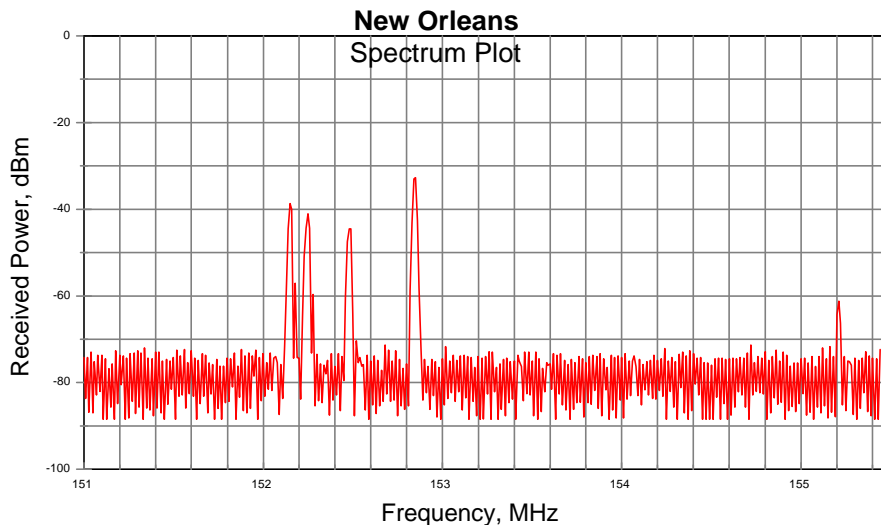

Figure 2-8
151-156 MHz Band

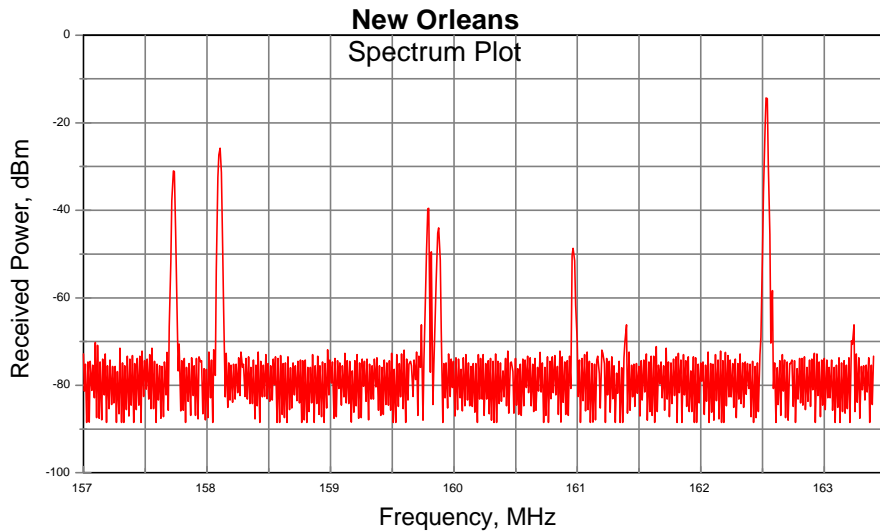

Figure 2-9
157-163.5 MHz Band

The figures show numerous maritime and land mobile emitters in this band in New Orleans. The transmitter that produced the highest received power on the fireboat in New Orleans was weather channel WX1 at 162.55 MHz. The received power at the radio RF input jack from this transmitter was approximately -15 dBm. The IEC blocking tests showed that this power level would saturate the radio receivers. The power level fluctuated as the ship traversed the river due to shielding from the downtown buildings and bridges. This would explain why some spots on the river are more prone to interference than others.

Additional tests were performed by using the RF step attenuators to decrease the power of the interferers till the audible periodic interference was no longer heard in the radio receiver. This test was performed aurally and did not involve a SINAD measurement. The amount of attenuation each radio needed to effectively eliminate the audible interference is shown below in Table 2-2.

Table 2-2
Receiver Attenuation Values

Radio Receiver	Attenuation (dB)
B	20
E	20
F	10
G	30
H	10
I	30
K	20
M	10

As shown in Table 2-2, the range of attenuation needed to lower the power of the land mobile transmitters and weather channel emissions into the radio receiver to reduce the audible interference so that the 1 kHz test tone was audible ranged from 10 to 30 dB. The attenuation also reduced the sensitivity of the radio. The resolution for these tests was 10 dB. It was difficult to “hear” the change in the level of the audible interference using smaller steps of attenuation..

SECTION 3 INTERFERENCE COUPLING MECHANISMS

3. Blocking and Receiver Front-end Overload/Saturation

The receiver front-end overload/saturation and subsequent SINAD reduction at both Savannah and New Orleans would seem to be due to proximity of NOAA VHF weather broadcast transmitters to mariners on the Savannah and Mississippi rivers. At Savannah the NOAA weather station broadcasts at 162.4 MHz and is identified as WX2. The antenna used by this weather broadcast station is located on top of a 10 story building located under half a mile from the river's edge near the tugboat company dispatch office. During testing, the distance from the weather broadcast antenna to the tugboat ranged from one-half to five miles. The highest the received power of the weather station as measured at the input of each radio was approximately -10 dBm..

The tugboat company dispatch office had two antennas mounted on a tower that was approximately 100 feet high for their base station radio operations. One antenna was mounted about 50 feet up the tower and the other was mounted close to the top. The radio in the dispatch office did not experience audible interference and had a good SINAD measurement when connected to the lower antenna. When connected to the top antenna the dispatch radio experienced interference similar to that of the radio tested on the tugboat in the river. Visual inspection of the geometry between the lower antenna on the dispatch tower and weather antenna on the bank building showed that the weather signal was diffracting over the edge of an adjacent building that was taller than the lower antenna. This signal diffraction lowered the received power of the weather broadcast by about 20-30 dB over the top antenna and almost eliminated the interference in the dispatch office radio. This effect clearly demonstrated that the weather broadcast was partly to blame for the interference in some radios. Other test radios were also tested in this manner with the same result.

In New Orleans the NOAA weather station broadcasts at 162.55 MHz and is identified as WX1. The antenna used by this weather broadcast station is located on top of a 20 story building located about half a mile from the river's edge. During testing, the distance from the weather broadcast antenna to the fire boat ranged from about half a mile at location one to under two miles at location two. The highest the received power of the weather station as measured at the input of each radio was approximately -15 dBm.. The weather broadcasts were continuously on during the testing. The received power level changed as the boat moved in the river due to shielding and diffraction.

The IEC specification for blocking is -23 dBm at the radio RF input, which would result in a minimum SINAD of 14 dB. In Savannah the received power of the NOAA signal, which resembles the unwanted signal in the IEC blocking test, was 13 dB above the specification. In New Orleans the received power of the NOAA signal was 8 dB above the specification.

Some RF filtering in the front end of marine radios might be expected because the desired signal channels and the weather broadcasts were separated by at least 700 kHz or more. However, the marine radios that were tested were designed to receive all VHF marine weather broadcast channels and therefore do not have any RF rejection to NOAA weather broadcasts. In addition, the marine VHF radio receivers also do not have any RF rejection to land mobile transmitters operating within the band.

Receiver front-end overload/saturation may not be audible or apparent to the radio operators. The

weather broadcasts were audible in only one of the radio receivers while it was tuned to a desired test channel. Non-audible interference would cause a reduction in the reception range for the radio receiver and would not be obvious to the radio operator. For example, if the radio operator was unable to discern a weak signal in the presence of the weather broadcasts or any other strong in-band signal, they might say that the radio had gone “deaf”. The radio operator would not be able to hear the person that they were trying to communicate with, but also would not hear any interference coming through the radio receiver. Hence, the radio was quiet and had gone “deaf”.

3.2 Intermodulation and/or Cross-modulation

In addition to maritime communications, the VHF maritime mobile band is used by land mobile systems for a variety of functions. The functions and the frequencies that these land mobile systems operate on are listed in Parts 22 (Public Mobile Service) and 90 (Private Land Mobile Radio Services) of the Code of Federal Regulations (CFR). The spectrum recordings that were taken in Savannah and New Orleans showed that numerous land mobile systems that operate according to these parts of the CFR were active in both areas.

In Savannah and New Orleans, the audible intermodulation interference in the radio receivers seems to be attributable to land mobile transmitters and the NOAA VHF weather broadcasts. The land mobile transmitters and the weather broadcasts were identified as possible sources of interference by listening to the interference and observing the display on the spectrum analyzer. However, the interference mechanism may be a combination of intermodulation and/or cross modulation products. An intermodulation product is due to two or more signals driving the radio receiver circuitry into non-linear operation. Cross modulation is the result of an interfering signal that is strong enough to act as a local oscillator in the radio receiver.

The land mobile transmitters seemed to initiate the audible interference events. This was observed by listening to the radio and watching the spectrum analyzer’s display. The audible interference only occurred when the land mobile transmitters were active. During the audible interference events, receiver addressing tones could be heard followed by land mobile data transmissions. During the land mobile transmissions the weather broadcast could also be heard as somewhat garbled but identifiable voice interference in the radio receiver.

Previous studies done by the FCC have shown that when WX2 is not broadcasting in Savannah, the audible interference does not occur (this test was not performed by NTIA). According to the FCC the WX2 weather broadcast has been transmitting from the same antenna location for over 10 years and complaints from mariners about the interference only started to be reported in the past few years as land mobile systems were deployed in the area. During our tests, WX2 was continuously transmitting and the audible interference only occurred when the land mobile transmitters became active. The results of these tests show that the combination of land mobile transmitters and weather broadcasts in the same EM environment can generate interference in marine VHF radio receivers.

Personnel from the FCC Compliance Bureau field office based in New Orleans have investigated the reports of interference in Savannah and New Orleans and stated that the land mobile systems and NOAA weather broadcasts in Savannah and New Orleans are operating within Federal guidelines with respect to output power, signal deviation, and spurious emissions

Although land mobile transmitters have been identified as a component of the audible interference, determining which land mobile transmitters are causing the interference on specific marine channels is difficult. Inspections of the spectrum recordings show that numerous land mobile transmitters were active when these recordings were made and the interference was present. With so many land mobile transmitters active when the interference was heard, it was difficult to determine just exactly which ones were contributing to the interference on the desired test channels.

The received power levels of the land mobile transmitters at the radios RF input were greater than the unwanted signal power levels that were used in the IEC intermodulation rejection ratio test. The received power levels of the land mobile transmitters was up to -27 dBm at the radios RF input and generated intermodulation interference in all receivers except radio M and Radio L operating in local mode. Testing the radios in the laboratory to the IEC intermodulation rejection ratio procedures revealed that unwanted signal powers ranging from -55 to -34 dBm were sufficient to generate the intermodulation interference and lower the SINAD to 14 dB. The only radio which had laboratory test values equal to the land mobile received power levels was radio L operating in local mode. Radio was not available for testing when the laboratory test were performed.

3.3 RTCM RECEIVER STANDARD

RTCM has developed a draft receiver standard for marine VHF radios that is based on the received powers of the land mobile and NOAA transmitters that were measured at the RF input of the test radios. The standard is a combination of blocking and intermodulation rejection ratio tests which are similar to tests and procedures outlined in IEC 1097. The major difference between the RTCM test and the IEC tests is that the unwanted signal powers in the RTCM standard are set at specific levels while the IEC tests are referenced to the receivers maximum usable sensitivity. In the RTCM standard, the blocking signal is set at -15 dBm at the receiver input and the two unwanted signals that simulate the land mobile transmitters are set at -27 dBm. The RTCM performance requirement is that the receiver have a minimum SINAD of 14 dB with a wanted signal power of -107 dBm at the receiver RF input and the afore mentioned unwanted signals also being present.

SECTION 4

EVALUATION of RADIO PERFORMANCE

The performance of the radios was evaluated using the SINAD histograms and by listening to the radio during the tests. Radios that had histograms which showed a distribution of SINAD measurements to higher values for a greater percentage of time performed better than those radios that had low SINAD values for higher percentages of time. Some radios performed better in Savannah than New Orleans.

A brief discussion of each radio's histograms from the New Orleans and Savannah tests is given in the following paragraphs.

Radio A

Radio A is a recreational grade fixed mount radio. The histogram for this radio (Figure B-7) shows that this radio receiver never had a SINAD above 4 dB and that most of the SINAD distribution was in the 1-3 dB range. The radio was in a constant state of saturation and the 1 kHz test tone was almost inaudible due to the intermodulation interference. This was the only radio in which the weather broadcast could be heard when the radio was tuned to the test channel. The radio broke and was not tested in New Orleans. This radio performed poorly.

Radio B

Radio B is a commercial grade fixed mount radio. The histogram for this radio (Figure B-6 and Figure C-4) shows that in Savannah the radio had a SINAD distribution of 0-13 dB while in New Orleans the values were never above 4 dB.

Radio E

Radio E is a recreational grade handheld radio. The histograms for this radio (Figures B-9 and C-10) show that this radio never had SINAD measurements above 4 dB and that most of the distribution was in the 0-3 dB range. This radio had a plastic housing and case penetration may have added to its poor performance.

Radio F

Radio F is a commercial grade fixed mount radio. The histograms for this radio (Figures B-3 and C-7) show SINAD measurements from 3-14 dB in Savannah and 1-13 dB in New Orleans. This radio seemed to function well in Savannah but was more degraded in New Orleans. It had better performance than the recreational grade radios but not as good performance as the other commercial grade radios.

Radio G

Radio G is a recreational grade handheld radio. The histograms for this radio (Figures B-10 and C-9) shows that this radio receiver had SINAD measurements from 1-5 dB and that most of the SINAD distribution was in the 1-3 dB range. The radio was in a constant state of saturation and the 1 kHz test tone was almost inaudible due to the intermodulation interference. This radio performed poorly.

Radio H

Radio H is a recreational grade fixed mount radio. The histograms for this radio (Figures B-3 and C-3) show that this radio receiver had SINAD measurements from 1-14 dB and that most of the SINAD distribution was in the 6-12 dB range. This radio seemed to work better in Savannah than New Orleans. For a recreational grade radio it had moderate performance.

Radio I

Radio I is a recreational grade fixed mount radio. The histograms for this radio (Figure B-5 and C-6) show that this radio receiver never had a SINAD above 5 dB and that most of the SINAD distribution was in the 1-3 dB range. The radio was in a constant state of saturation and the 1 kHz test tone was inaudible due to the intermodulation interference. This radio had an unshielded plastic housing and case penetration interference was possibly occurring. This radio performed terribly.

Radio K

Radio K is a recreational grade fixed mount radio. The histograms for this radio (Figures B-8 and C-8) show that this radio receiver never had a SINAD above 7 dB and that most of the SINAD distribution was in the 1-5 dB range. The radio was in a constant state of saturation and the 1 kHz test tone was almost inaudible due to the intermodulation interference. This radio performed poorly.

Radio L

Radio L is a commercial grade fixed mount radio that incorporates a local/distance switch in its receiver that is accessible from the front panel of the radio. The histograms for this radio (Figures B-1, B-2 and C-1 and C-2) show that in distance mode (Figures C-1 and B-1) this radio receiver had SINAD measurements from 1-14 and in local mode had measurements from 8-18 dB. Using the local mode setting on the radio receiver removed almost all of the audible interference. This radio performed well in local mode and had marginal performance in distance mode.

Radio M

Radio M is a commercial grade fixed mount radio. The histograms for this radio (Figure C-5) shows that this radio receiver SINAD values from 1-14 dB. This radio had an externally adjustable attenuator for operations in harsh EM environments that was also connected to the radio's squelch control. Although the radio was able to operate in New Orleans when the attenuator was set to its full value, the squelch closed and about 3 dB more of desired signal power was needed to restore the SINAD. The radio was not in the test inventory for the Savannah tests. This radio worked well.

SECTION 5

CONCLUSIONS and RECOMMENDATIONS

5. Conclusions

The following conclusions can be drawn from these tests:

1. VHF FM marine radios are experiencing receiver saturation and intermodulation/cross modulation interference on numerous channels at Savannah, Georgia and New Orleans, Louisiana, including those used for key ship-to-ship and safety communications.

2. The received power levels of the land mobile emitters in New Orleans and Savannah at the radios RF input was up to -27 dBm, which exceed the levels of simulated interference set by the IEC 1097 intermodulation test by up to 28 dB.

3. The received power levels of the NOAA VHF weather broadcasts in New Orleans and Savannah at the radios RF input was up to -10 dBm, which exceed the levels of simulated interference set by the IEC 1097 blocking test by up to 19 dB.

4. The receiver saturation and intermodulation/cross modulation interference appears to be attributable to CFR Title 47 Parts 22 and 90 land mobile operations in the marine VHF band and NOAA VHF weather broadcasts.

5. The marine VHF radios do not have any protection against land mobile operations and weather broadcasts that operate within its receiver passband.

6. NOAA weather radio and land mobile transmitter antennas are very close to the river's edge in Savannah and New Orleans resulting in higher received unwanted signal powers at the marine radios RF input, which further exacerbates the interference problems.

7. The FCC Compliance and Information Bureau field office in New Orleans has stated that the land mobile systems in Savannah and New Orleans are operating within CFR Parts 22 AND 90 Title 47 guidelines with respect to output power, signal deviation, and spurious emissions.

8. Some high quality commercial grade radios have an internal attenuator selectable with a local/distance switch or squelch control that reduces the sensitivity of the radio receiver. Such radios were capable of operating satisfactorily in the New Orleans and Savannah electromagnetic environment.

8. Recreational grade radios were able to overcome the interference with an external attenuator at the receiver RF input which ranged in values from 10 to 30 dB. The sensitivity of the radio was also degraded by the attenuation.

9. The RTCM SC-117 draft receiver standard for marine VHF radios, which is based on interference power levels that were recorded in New Orleans and Savannah, should be sufficient to protect marine radio receivers from saturation and intermodulation interference.

5.1 Recommendations

It is recommended that the Coast Guard consider the following items in resolving reports of interference in marine VHF radios at US ports and waterways:

1. In the interests of increased public safety and environmental concerns for maritime operations on rivers, lakes, inland waterways, and coastal areas of the United States, the Coast Guard district offices should inform mariners which radios are commercially available that can function at Savannah and New Orleans when complaints of interference are sent to their offices.

2. Promoting the RTCM SC-117 receiver standard among different manufacturers so that more radios are available at an affordable price to the general boating public which can meet the standard.

3. To reduce interference from occurring in marine VHF radio receivers from future deployments of NOAA VHF weather broadcasts near ports and waterways, working with NOAA to develop antenna siting guidelines for NOAA VHF weather transmitters. These guidelines could possibly be incorporated in the NTIA manual. The guidelines should be based on marine radio performance that is in accordance with the RTCM receiver standard.

4. To reduce interference from occurring in marine VHF radio receivers from future operations of land mobile systems in the VHF band, working with the FCC and NTIA in developing antenna siting guidelines for land mobile transmitters that can be incorporated in the Code of Federal Regulations. The guidelines should be based on marine radio performance that is in accordance with the RTCM SC-117 receiver standard.

APPENDIX A

The following procedures were used for the radiated tests with the test set-up shown in Figure A-1.

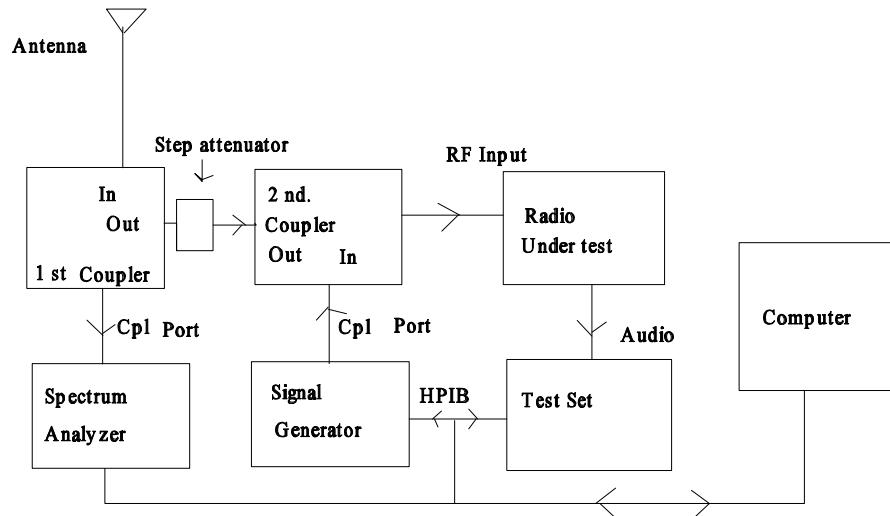

Figure A-1
Test Set-Up

1. The test equipment was placed on a workbench located on the maindeck or in the wheelhouse of the ships and test personnel traveled to locations on the Mississippi and Savannah Rivers where the performance of marine radios was reported to be degraded.
2. An RF termination was connected to the input of the first coupler.
3. The signal generator and the radio under test were tuned to the frequency of the channel being tested. The signal generator functioned as the desired signal transmitter in all tests.
4. The RF power of the signal generator was adjusted till the SINAD of the radio under test was approximately 20 dB.
5. The input of the first coupler was connected to a 10 foot long VHF whip antenna mounted on the bridge of the ship, which was about twenty feet above the water. The whip antenna was used to introduce emitters from the EM environment into the circuit. The emitters caused a degradation in the receiver's SINAD measurement.
6. The computer monitored the SINAD of the radio under test and instructed the spectrum analyzer (which is connected to the antenna through the coupled port of the first coupler) to take a "snapshot" of the 150-174 MHz band when the SINAD fell below 14 dB. The spectrum snapshot was then stored in the computer.

Appendix B

This appendix contains the radio histograms which were derived from SINAD measurements taken in Savannah. Radios which have histograms with their major distribution of SINAD measurements towards greater values for a greater amount of time had better performance and the 1 KHz test tone was more audible during the interference events.

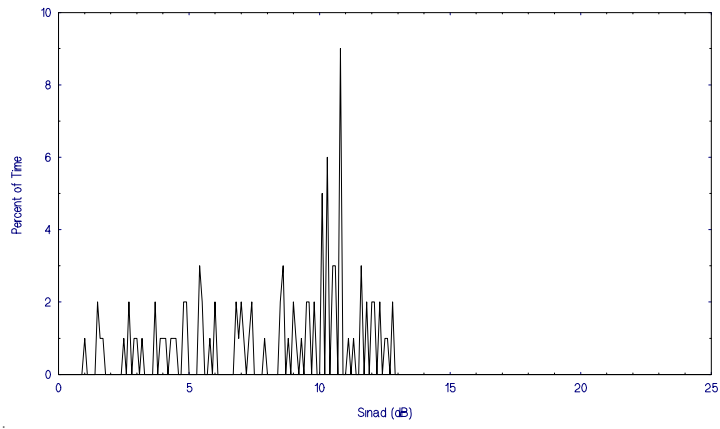

Figure B-1
Radio L distance Mode

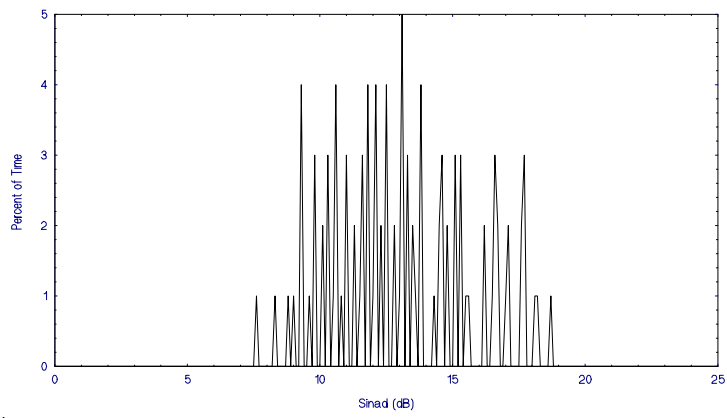

Figure B-2
Radio L Local Mode

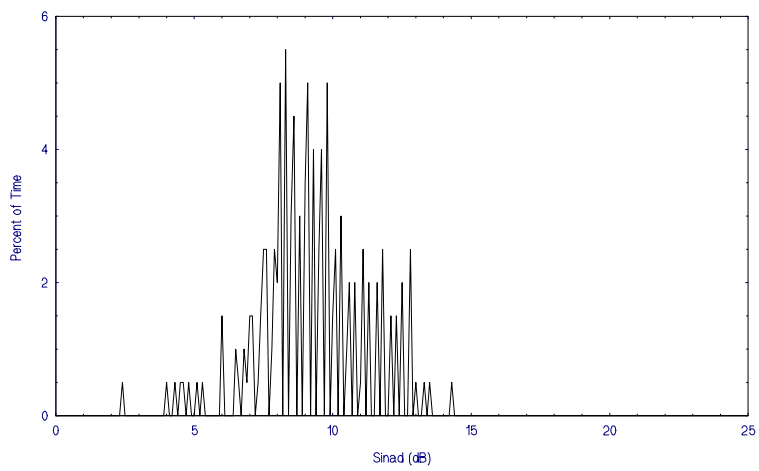

Figure B-3
Radio H

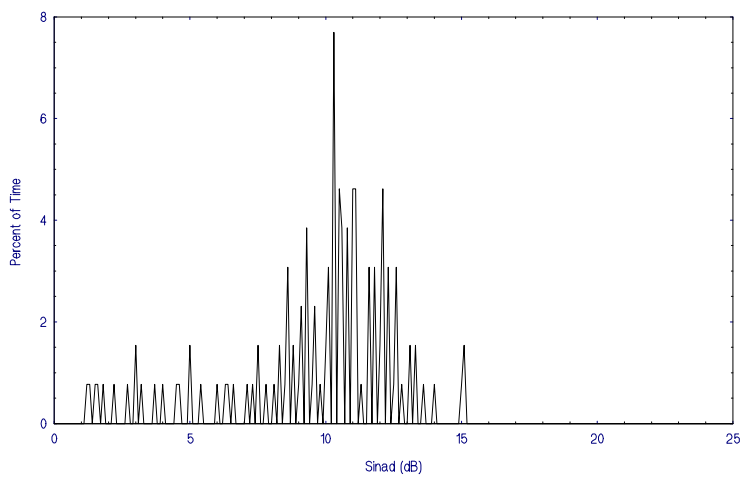

Figure B-4
Radio F

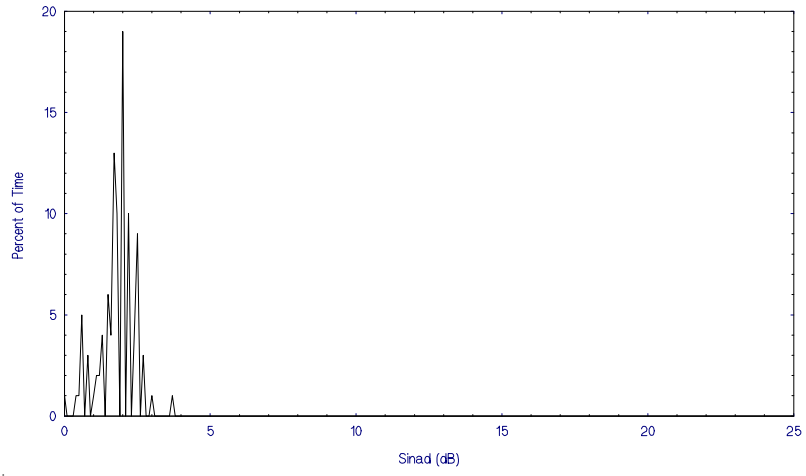

Figure B-5
Radio I

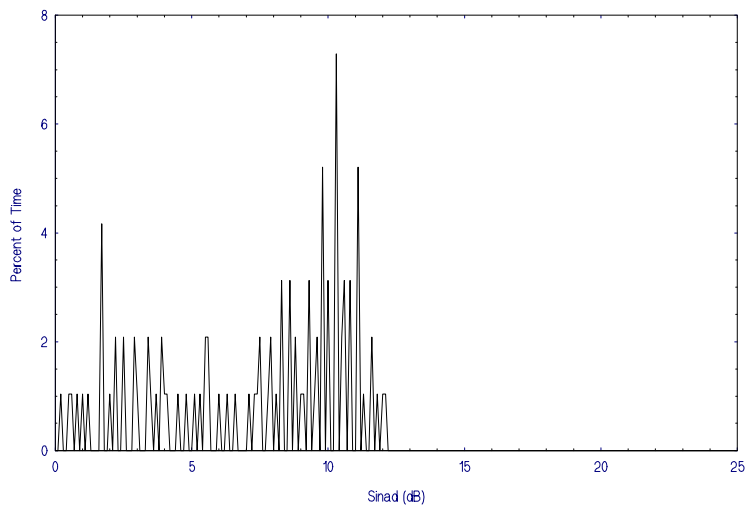

Figure B-6
Radio B

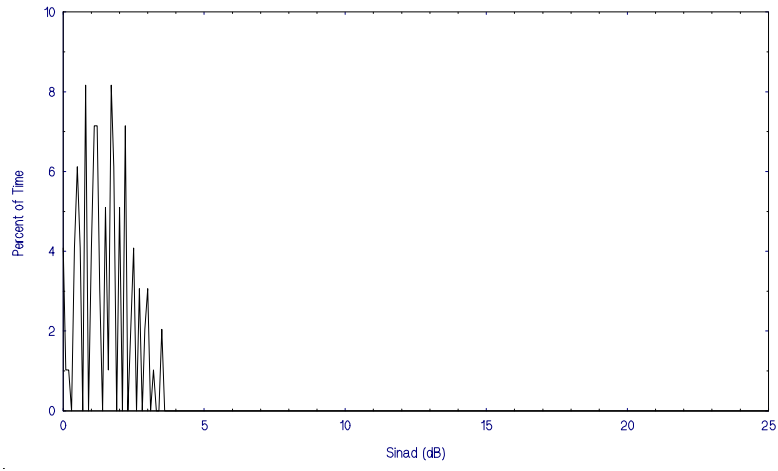

Figure B-7
Radio A

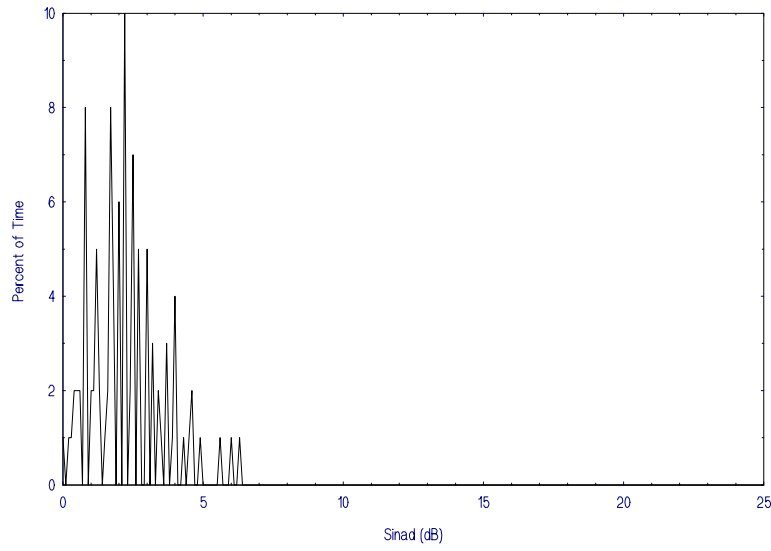

Figure B-8
Radio K

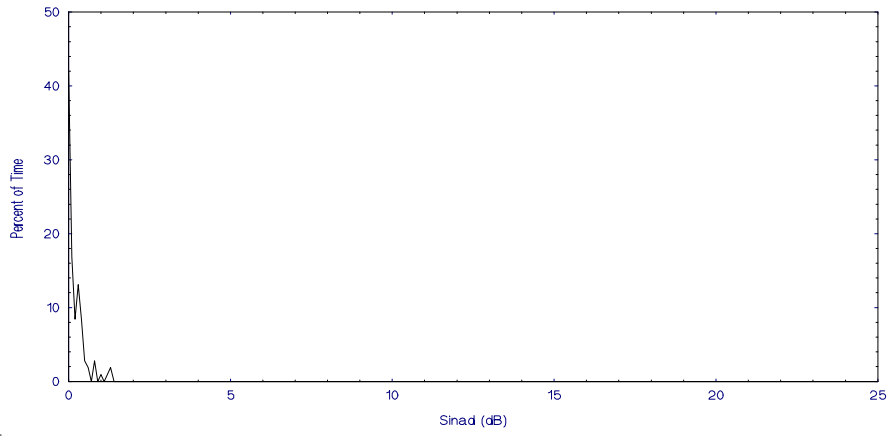

Figure B-9
Radio E

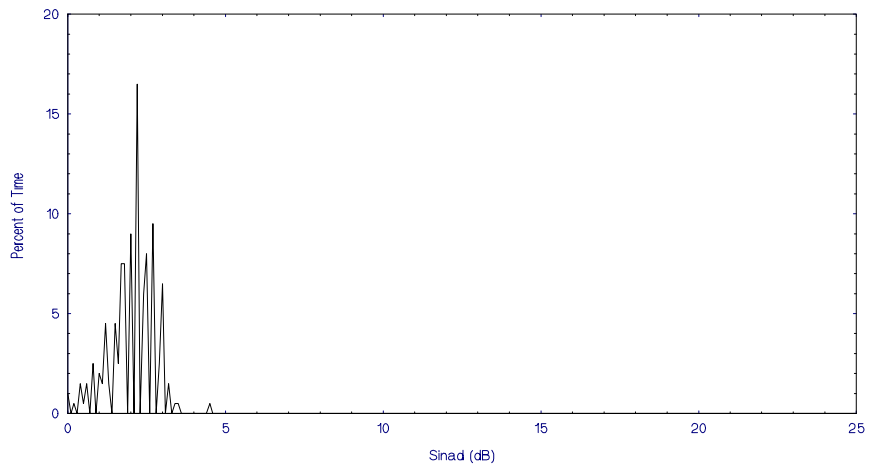

Figure B-10
Radio G

Appendix C

This appendix contains the radio histograms which were derived from SINAD measurements taken in New Orleans. Radios which have histograms with their major distribution of SINAD measurements towards greater values for a greater amount of time had better performance and the 1 KHz test tone was more audible during the interference events.

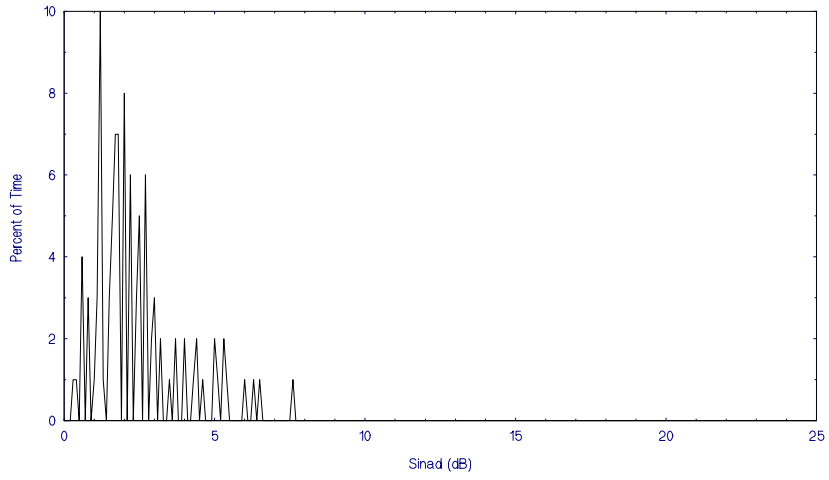

Figure C-1
Radio L, Distance Mode

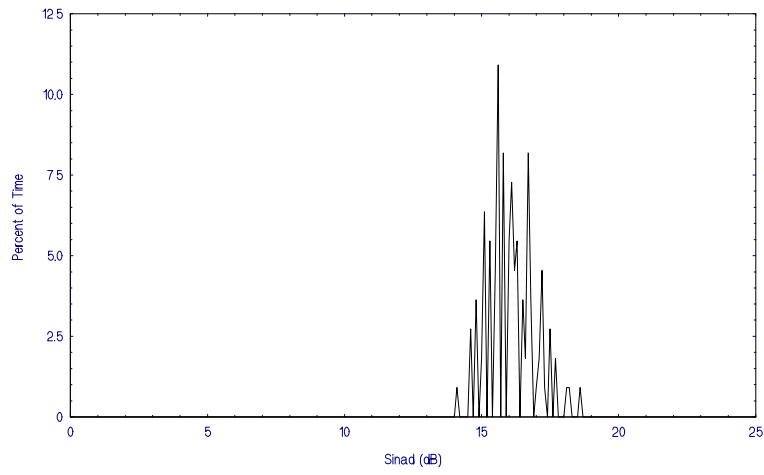

Figure C-2
Radio L, Local Mode

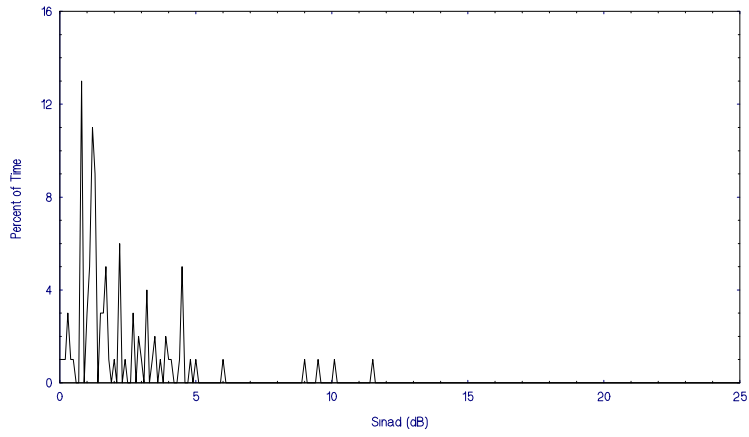

Figure C-3
Radio H

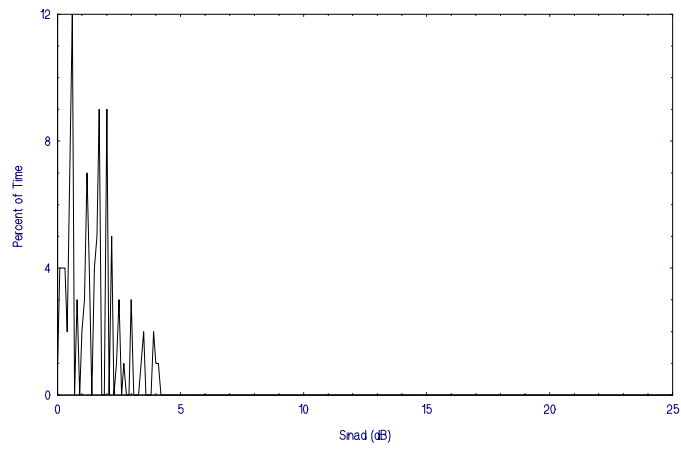

Figure C-4
Radio B

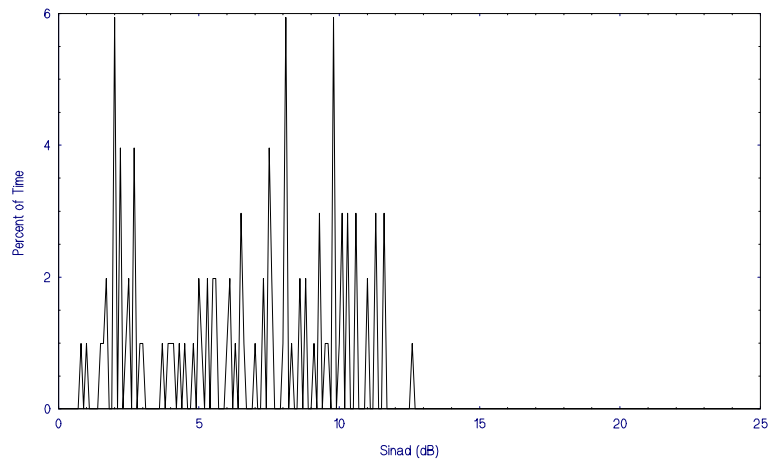

Figure C-5
Radio M

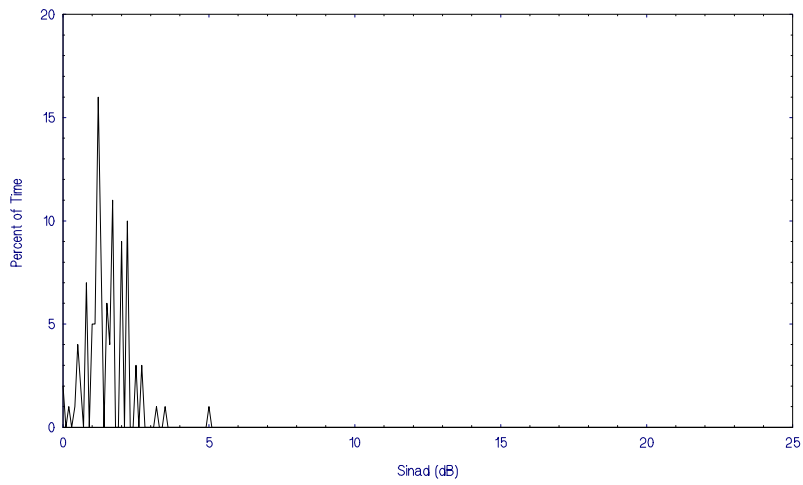

Figure C-6
Radio I

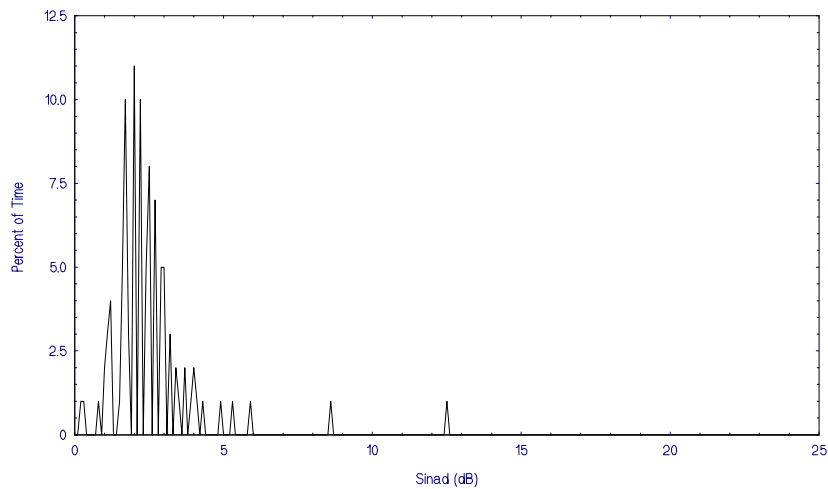

Figure C-7
Radio F

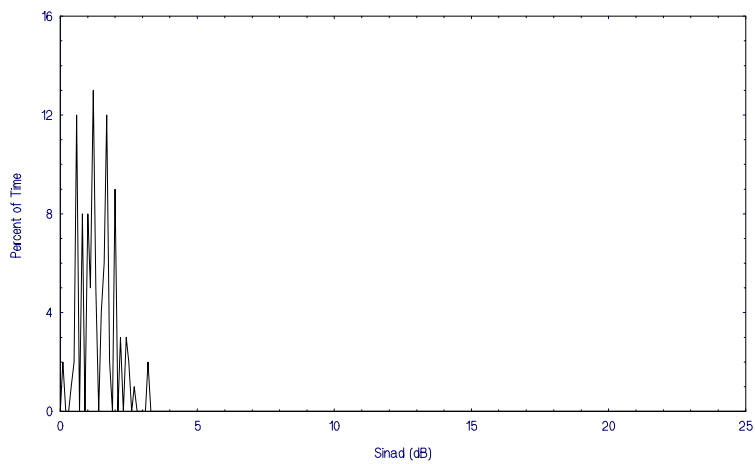

Figure C-8
Radio K

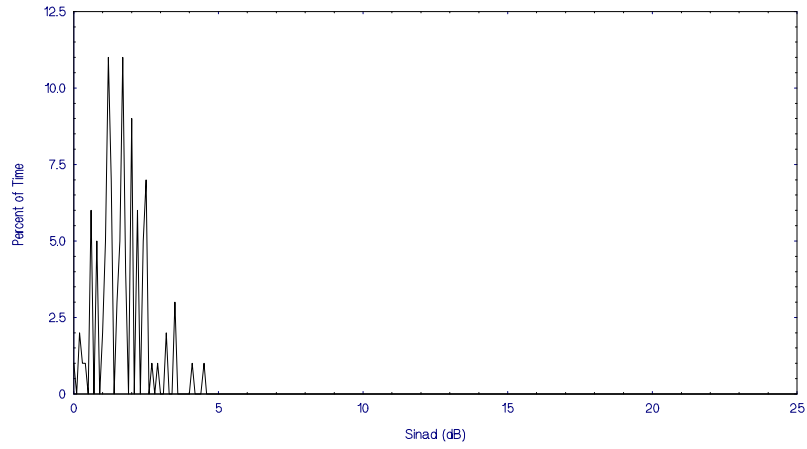

Figure C-9
Radio G

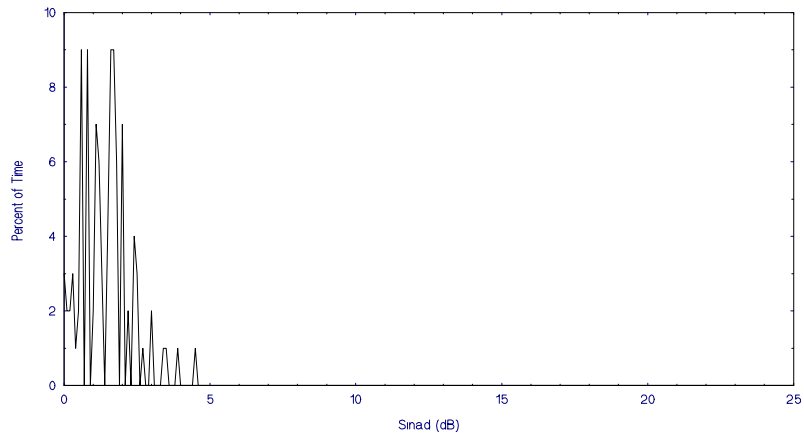

Figure C-10
Radio E