

NTIA Report 01-389

**Addendum to NTIA Report 01-384:
Measurements to Determine Potential
Interference to GPS Receivers from
Ultrawideband Transmission Systems**

**J. Randy Hoffman
Michael G. Cotton
Robert J. Achatz
Richard N. Statz**



**U.S. DEPARTMENT OF COMMERCE
Donald L. Evans, Secretary**

September 2001

This Page Intentionally Left Blank

This Page Intentionally Left Blank

Product Disclaimer

Certain commercial equipment, instruments, or materials are identified in this report to specify the technical aspects of the reported results. In no case does such identification imply recommendation or endorsement by the National Telecommunications and Information Administration, nor does it imply that the material or equipment identified is necessarily the best available for the purpose.

This Page Intentionally Left Blank

This Page Intentionally Left Blank

CONTENTS

	page
EXECUTIVE SUMMARY	vii
ABSTRACT	1
1. INTRODUCTION	1
2. MEASUREMENT SYSTEM AND PROCEDURES	2
3. RESULTS	6
4. CONCLUSIONS	15
5. REFERENCES	17
APPENDIX A: HARDWARE SPECIFICATION	A-1
APPENDIX B: GPS PERFORMANCE MEASUREMENTS RESULTS	B-1

This Page Intentionally Left Blank

This Page Intentionally Left Blank

EXECUTIVE SUMMARY

In response to the Federal Communications Commission (FCC) May 2000 Notice of Proposed Rulemaking [1] concerning the use of ultrawideband (UWB) devices, NTIA Reports 01-384 and 01-389 describe measurements to determine interference potential to global positioning systems (GPS) from UWB devices. Measurements were conducted on four different GPS receivers by combining varying levels of different UWB signals with simulated GPS satellite signals and determining the effects on GPS receiver performance. The results of the first two GPS receivers are described in NTIA Report 01-384 [2] and the results of the second two receivers are described in NTIA Report 01-389 [3]. The primary objective of these measurements was to determine the effects of UWB interference on GPS receivers; a secondary objective was to identify metrics that are reflective of receiver performance for the intended application and to establish repeatable measurement methodologies. The results have provided the technical information needed by NTIA to develop policies for use of UWB by the Federal government [4] and to work with the FCC to develop rules and regulations for UWB emissions.

Background

UWB signals, in general, consist of a sequence of narrow pulses sometimes encoded with digital information. They are characterized by modulation methods that vary pulse timing and position rather than the more conventional techniques of varying frequency, amplitude, or phase. Narrow pulses (on the order of nanoseconds) spread power across a wide bandwidth and reduce power density. UWB proponents argue that the power spectral density decreases below the threshold of narrowband receivers, hence causing negligible interference.

GPS is a powerful enabling technology that has created new industries that are fully dependent upon GPS signal reception. It is presently used in aviation for en-route and non-precision approach landing phases of flight. Precision-approach services, runway incursion, and ground traffic management are currently being developed. On our highways, GPS assists in vehicle guidance and monitoring; public safety and emergency response; resource management; collision avoidance; and transit command and control. Non-navigation applications are often grouped into geodesy and surveying; mapping, charting, and geographic information systems; geophysical measurement and monitoring; meteorological applications; and timing and frequency. Planned systems, such as Enhanced 911, personal location, and medical tracking devices are soon to be commercially available. Moreover, the U.S. telecommunications and power distribution systems are dependent upon GPS for network synchronization timing.

Measurement System

The test setup consisted of three segments – a GPS-source segment, a UWB-source segment, and a GPS-receive segment. The GPS-source segment was further divided into two components – a GPS satellite signal source and a noise source. The GPS satellite signals were generated by a simulator, allowing for repetition of the same satellite constellation over the same simulated date and time. The minimum number of satellites for a receiver to operate nominally, typically four, was chosen. The noise source, emulating the various sources of natural and man-made noise, was combined with the GPS signal to represent a GPS system operating under worst-case, real-world conditions.

GPS receivers were exposed to a broad range of single-source and aggregate UWB signals during the interference measurements. Each UWB signal was injected into the specific GPS receivers operating under worst-case, real-world noise conditions. Aggregate UWB measurements were conducted by combining independent UWB signals to create different multi-source UWB interference scenarios. Each of the individual UWB sources was generated using UWB devices with a pulse narrow enough to produce frequency components in the GPS band. Two types of pulse generators were used, one with a pulse width of 0.500 ns and the other with a pulse width of 0.245 ns. While the shape and width of the two generators are different, the characteristics of the two signals within the GPS band are identical.

The four GPS receivers tested were chosen from a range of different technologies and applications. The first device was a basic receiver used for ground mobile guidance systems. The second device was a high precision surveying receiver that utilizes multiple specialized techniques for improving accuracy. The third device was a reconfigurable receiver used for multiple applications and which employs many of the most modern techniques for signal processing. The fourth device was an enroute aviation receiver. Each of the signals were summed together and fed into an amplifier/filter combination used to emulate the bandwidth and gain of the antenna unit of the respective receiver. The power of the UWB signals was computer controlled, and the entire measurement process was automated for continuous, uninterrupted data acquisition.

UWB Signal Characteristics

Based on information provided by NTIA Report 01-383 [5], a range of signal types were chosen to best represent the range of UWB signal types used in the real world. Thirty-two different types of UWB signals were generated for the single-source measurements by varying the pulse repetition frequency (PRF), pulse spacing mode, and gating. PRF refers to the sequential rate at which the pulses are generated, gating refers to the process of distributing the pulses in bursts, and pulse-spacing-mode refers to the manner in which the pulses are spaced in time with respect to each other. For these measurements, there were four different

PRFs (0.1 MHz, 1 MHz, 5 MHz, and 20 MHz), two types of gating (either 20% duty cycle with a 4 ms pulsed on-time or pulsed on 100% of the time), and four types of pulse spacing (uniform pulse spacing, on-off-keying, absolute-referenced dithering, and relative-referenced dithering). Uniform pulse spacing (UPS), as the name implies, is a pulse train of equal spacing. On-off-keying (OOK) refers to the process of “turning off” certain pulses to represent a binary bit stream. Dithering refers to varying the spacing between pulses, either in relation to a clock reference (ARD) or in relation to the other pulses (RRD).

As an adjunct to the interference measurements, each of the single-source and aggregate UWB signals were characterized for frequency-spectrum and time-varying characteristics. Most noteworthy are the spectral characteristics of the different pulse spacing modes. UPS signals have power gathered up into discrete areas of the frequency spectrum (spectral lines) at intervals equal to the PRF. OOK signals have spectral lines, but they also have a continuous spectral component. Dithered signals can have an entirely smooth spectrum, which is characteristic of Gaussian noise. Gating has the additional effect of spreading the power of spectral lines across a wider area of the frequency spectrum. Time-varying characteristics of each of the UWB signals were summarized using amplitude probability statistics. In the end, UWB characteristics were correlated with GPS receiver performance metrics.

Performance Criteria

The two primary performance metrics for measuring GPS receiver performance were satellite break-lock (BL) and reacquisition time (RQT), where the former is defined as a break in satellite signal tracking and the latter is the time required to reestablish tracking of a satellite signal after BL. These two metrics bracket a region of reduced receiver performance. The associated performance criteria is the maximum UWB signal power below BL for which the GPS receiver can regain satellite signal tracking in a reasonable time, where the definition of “reasonable time” is left to GPS users. The performance criteria must, therefore, be defined by the user, taking into consideration the permissible reacquisition time for the specific application.

Measurement Procedures

BL measurements consist of turning off interference, establishing lock, turning on interference, and sampling the receiver’s loss-of-lock indicator once per second over the BL measurement duration (approximately 17 minutes). If the receiver never breaks lock, then the interference power is doubled for the next measurement. Measurements at increasing interference power are repeated until BL occurs. Once BL occurs, interference power is decreased by 1 dB (i.e. a factor of 1.26) until lock is maintained continuously over a measurement duration. The BL point is defined as a point 1 dB greater than the highest

interference power that did not cause BL. During BL measurements, the following observational parameters were sampled once per second in order to provide additional information about receiver degradation: pseudorange, observation time, clock offset, carrier phase, Doppler frequency shift, signal-to-noise ratio, potential cycle slip, position data, and receiver tracking status.

RQT measurements consist of turning off the satellite of interest, applying interference, delaying 10 seconds, turning on the satellite, and measuring the number of seconds until the receiver achieves lock. Reacquisition occurs when lock is achieved within 2 minutes and maintained for at least 1 minute. Ten RQT measurements are performed at each interference power level. If reacquisition occurs at least once, then interference power is increased by 2 dB (i.e. a factor of 1.58). Measurements at increasing interference power are repeated until the receiver never reacquires for all 10 RQT measurements.

Summary of Results

Based on analysis of the acquired data, the following trends were observed regarding UWB characteristics and the associated impact on GPS receiver performance:

1. Any time the UWB signal has a uniform pulse spacing, there are spectral lines, and when these spectral lines lie within the GPS band, there is potential for alignment with spectral lines of the GPS signal. This alignment is particularly invasive; impact is directly related to the magnitude of the specific GPS and UWB spectral lines for which alignment occurs.
2. On-off-keying, since it too has spectral lines, can have a significant impact on GPS receiver performance. However, the effects of OOK are less detrimental than the effects of UPS because the OOK spectral power is distributed between spectral lines and a noise component; hence, the power contained in each line is less.
3. Dithering can reduce the impact of UWB interference on a GPS receiver by reducing or eliminating spectral lines in the GPS band.
4. Higher PRFs have a greater interference effect for two reasons. One reason is that, for those cases with spectral lines, greater power is gathered into each spectral line. The other reason is that higher PRFs result in a greater percentage of time for which the pulses are present.
5. Gating reduces the interference impact on receivers for two reasons. One reason is that the power of individual spectral lines is spread out into multiple lines, thus reducing the power contained in any single line. The other reason is that, for signals of equal gate-on power density, the percentage of time the pulses are present is less with gating.

While there are variations in receiver responses, there are some consistent patterns and notable deviations between receivers. The second receiver deviates the most from the other

three since, unlike its counterparts, it is a high precision GPS receiver with a low tolerance for carrier phase discontinuities. The other three receivers show remarkably similar patterns with some slight variations. All three have the same basic BL response to the different UWB signal types. The fourth receiver, however, shows a greater sensitivity to dithered UWB interference which causes BL to occur at lower interference power levels relative to the first and third receivers.

There is a wide range of UWB signal types with a wide range of effects on GPS receivers. Depending upon the bandwidth of the receiver, the PRF, the pulse spacing mode, and the presence of gating, the UWB signal can be impulsive, Gaussian noise-like, or sinusoidal. With PRFs significantly less than the bandwidth of the receiver, UWB interference is impulsive and rarely causes loss of satellite lock. UWB signals with a high PRF and no dithering have strong spectral lines and are most invasive to the receivers. In some cases, the receivers showed significant performance degradation even if they never lost satellite lock. For instance, some gated UWB signals caused an elevated RQT for UWB signal power levels 10,000 times less than the highest interference level in the BL test, even though BL never occurred.

References

- [1] *Notice of Proposed Rulemaking*, ET Dkt. 98-153 (rel. May 11, 2000), Federal Register, June 14, 2000, vol. 65, No. 115, pp. 37332 - 37335.
- [2] J.R. Hoffman, M.G. Cotton, R.J. Achatz, R.N. Statz, and R.A. Dalke, "Measurements to determine potential interference to GPS receivers from ultrawideband transmission systems," NTIA Report 01-384, Feb. 2001.
- [3] J.R. Hoffman, M.G. Cotton, R.J. Achatz, and R.N. Statz, "Addendum to NTIA Report 01-384: measurements to determine potential interference to GPS receivers from ultrawideband transmission systems," NTIA Report 01-389, Sept. 2001.
- [4] D.S. Anderson, E.F. Drocella, S.K. Jones, M.A. Settle, "Assessment of compatibility between ultrawideband (UWB) systems and global positioning system (GPS) receivers," NTIA Special Publication 01-45, Feb. 2001.
- [5] W.A. Kissick, Ed., "The temporal and spectral characteristics of ultrawideband signals," NTIA Report 01-383, Jan. 2001.

This Page Intentionally Left Blank

This Page Intentionally Left Blank

**ADDENDUM TO NTIA REPORT 01-384:
MEASUREMENTS TO DETERMINE POTENTIAL INTERFERENCE TO GPS
RECEIVERS FROM ULTRAWIDEBAND TRANSMISSION SYSTEMS**

J. Randy Hoffman, Michael G. Cotton, Robert J. Achatz,
Richard N. Statz*

This addendum to NTIA Report 01-384 describes laboratory measurements on two additional Global Positioning System receivers to quantify the effects of ultrawideband interference on those receivers. The laboratory measurements were performed by inserting increased levels of UWB interference until an operating GPS receiver lost lock. At each interference level leading up to loss of lock, reacquisition time was determined. When possible, fundamental GPS measurements (e.g., pseudorange and carrier phase), status flags (e.g., potential cycle slips), and signal-to-noise ratio were also sampled.

Key words: global positioning system (GPS), ultrawideband (UWB), impulse radio, amplitude probability distribution (APD), interference measurement, noise, radio frequency interference (RFI)

1. INTRODUCTION

This addendum to NTIA Report 01-384 [1] further investigates potential interference to Global Positioning System (GPS) receivers by ultrawideband (UWB) signals. According to Part 15 of the Federal Communications Commission (FCC) rules, non-licensed operation of low-power transmitters is allowed if interference to licensed radio systems is negligible. On May 11, 2000, the FCC issued a Notice of Proposed Rulemaking (NPRM) [2] which proposed that UWB devices operate under Part 15 rules. This would exempt UWB systems from individual licensing and frequency coordination and allow them to operate under a new UWB section of Part 15, based on claims that UWB devices can operate on spectrum already occupied by existing radio services without causing interference. The NPRM calls for testing and analysis, so that risks of UWB interference are understood and critical radio services, particularly safety services such as GPS, are adequately protected.

Two receivers were tested to determine the performance degradation due to UWB interference. With only a few receiver-specific changes, the same basic test procedures described in NTIA Report 01-384 were utilized. For a full description of test methodologies, UWB signal characteristics, and data processing, the reader is referred to the parent report.

* The authors are with the Institute for Telecommunication Sciences, National Telecommunications and Information Administration, U.S. Department of Commerce, Boulder, CO 80305.

This addendum is organized as follows: Section 2 describes the features of the measurement system and procedures that are different from those described in the parent report, including a description of the GPS receivers and the types of parameters measured. Section 3 displays the experimental results and summarizes trends in performance degradation. Conclusions are drawn in Section 4.

2. MEASUREMENT SYSTEM AND PROCEDURES

The measurement test bed is comprised of three segments – GPS source, UWB source, and GPS receiver. The system configuration is illustrated in Figure 2.1 and hardware components and GPS receiver settings are specified in Appendix A. Each of the contributing signals (i.e., GPS, noise, and UWB) were filtered, amplified, and combined prior to input into the receiver. Signal powers were computer controlled using precision variable attenuators (VA). During GPS signal simulation, ionospheric, tropospheric, and multipath effects were turned off, and L2 was attenuated.

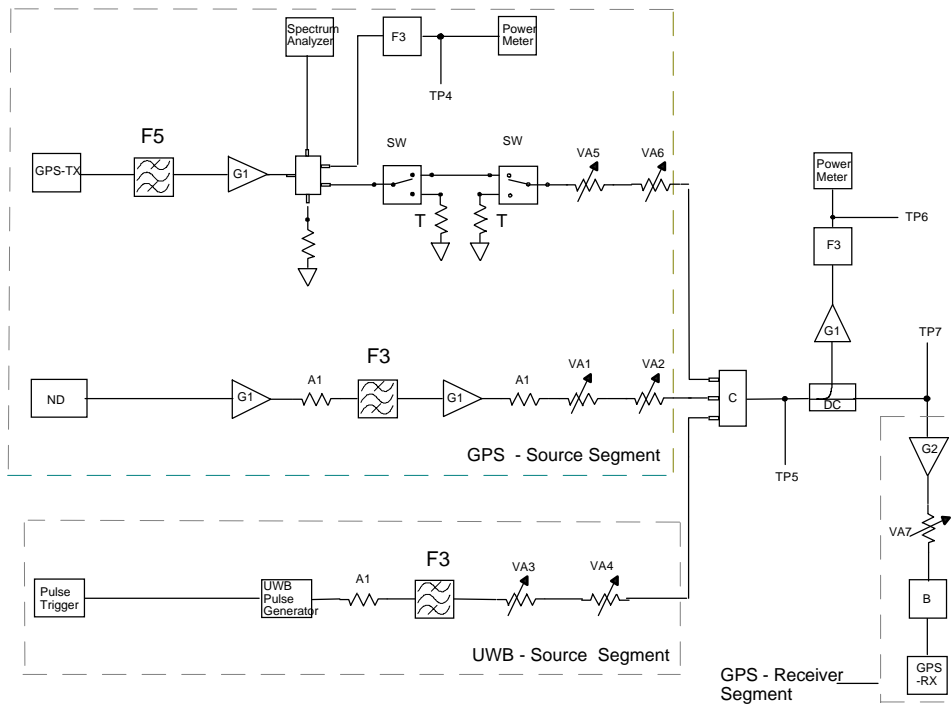

Figure 2.1. Block diagram.

A range of existing and potential UWB signals was created by varying three parameters – pulse repetition frequency (PRF), pulse spacing, and gating. For these measurements (as shown in Table 2.1) there are four PRFs (i.e., 0.1, 1, 5, and 20 MHz), four pulse spacing modes (i.e., uniform pulse spacing (UPS), on-off keying (OOK), 50% absolute referenced dithering (ARD), and 2% relative referenced dithering (RRD)), and two gating scenarios (i.e., no gating and 20% gating with a 4-ms on-time).

Table 2.1. UWB Signal Space

UWB Signal Parameter	Range
Average Power Density	As needed to induce effect on GPS receiver
Pulse Width	0.5 nanoseconds
Pulse Repetition Frequency	0.1, 1, 5, 20 MHz
Modulation, Dithering	UPS, OOK, 50% ARD, 2% RRD
Gating	100% (no gating) and 20% Duty Cycle with 4 ms gated on-time

Two different receivers, using different architectures, were tested. Receiver 3 (Rx 3) uses narrow correlator tracking technology; it also has L1/L2 cross correlator capabilities, but this was disabled by attenuating the L2 signal. Measurements confirmed that removing the L2 signal did not result in unexpected deleterious effects for the reported parameters. Carrier smoothing, for Rx 3, was also disabled. Receiver 4 (Rx 4) is a TSO-C129a aviation receiver without narrow correlator and cross correlating enhancements. Table 2.2 provides a comparison of the receivers tested thus far, including those in the parent report.

Table 2.2. Receiver Architectures

	Code Tracking	Carrier Tracking	Cross Correlator	Narrow-spaced Correlator
Rx 1	Yes	Yes	No	No
Rx 2	Yes	Yes	Yes	Yes
Rx 3	Yes	Yes	No	Yes
Rx 4	Yes	Yes	No	No

Rx 3 was tested using the four-satellite constellation described in the parent report. Rx 4, on the other hand, requires tracking of at least five satellites in order to use the least squares-residuals RAIM scheme [3]; therefore, satellite vehicle (SV) 11 was added to the constellation for this receiver. All five satellites were located above the horizon during the entire time for which data were acquired. SV 25 was chosen as the satellite for which all parameters were measured. The transmitted signal powers of the other satellites were set 5 dB greater than that of SV 25. Therefore, under the same interference conditions, the SV-25

signal-to-noise ratio is significantly less than the other satellites, and performance degradation is isolated to the SV-25 channel. Most importantly, as interference is increased the receiver loses lock on SV 25 first.

For UWB interference testing on both receivers, the simulated GPS signal level for SV 25 was set at the minimum guaranteed coarse acquisition (C/A) code signal power specification of -130 dBm. Gaussian noise was injected into the receiver at a level of -93 dBm/20 MHz for the purpose of simulating worst case cross-correlation noise from other GPS satellites. Based on a 2-dB implementation loss, this gave a carrier-to-noise ratio (C/N_o) of 34 dB-Hz upon which UWB interference was added (see section 4.2.1 in the parent report for further details). All power levels are referenced to point TP7 shown in Figure 2.1.

Multiple observables were recorded during BL testing for Rx 3 but reacquisition time (RQT) was measured only for the Gaussian noise case. Rx 4 has a limited output with very few observables. Carrier-to-noise ratio, position, and elevation information were available, but pseudorange and delta pseudorange were not. For Rx 4, both BL and RQT were measured.

Both receivers were tested for noise figure (NF) and linear compression by injecting increasing levels of Gaussian noise to the BL point while simultaneously recording the C/N_o reported by the receivers for the monitored satellite (SV 25). For this test, all interference sources and GPS signal power were referenced to TP7 (Figure 2.1), immediately prior to the low noise amplifier, and the power level of SV 25 was set at -130 dBm (the same as for the interference measurements). One can see from Figures 2.2 and 2.3 that because the curves are relatively linear for the 5 data points with the highest noise power, no compression occurred. NF is determined by finding the 3-dB point below the maximum achievable C/N_o and the corresponding noise power density (P) in dBm/Hz (denoted by the thick vertical line). NF is given by the approximation

$$NF = P - 10 \log_{10}(kT),$$

where k is Boltzman's constant and T is the temperature in Kelvin ($10 \log_{10}(kT) = -174$ dB at room temperature). Based on these calculations, the noise figures for Rx 3 and Rx 4 are 1.5 dB and 1.8 dB respectively.

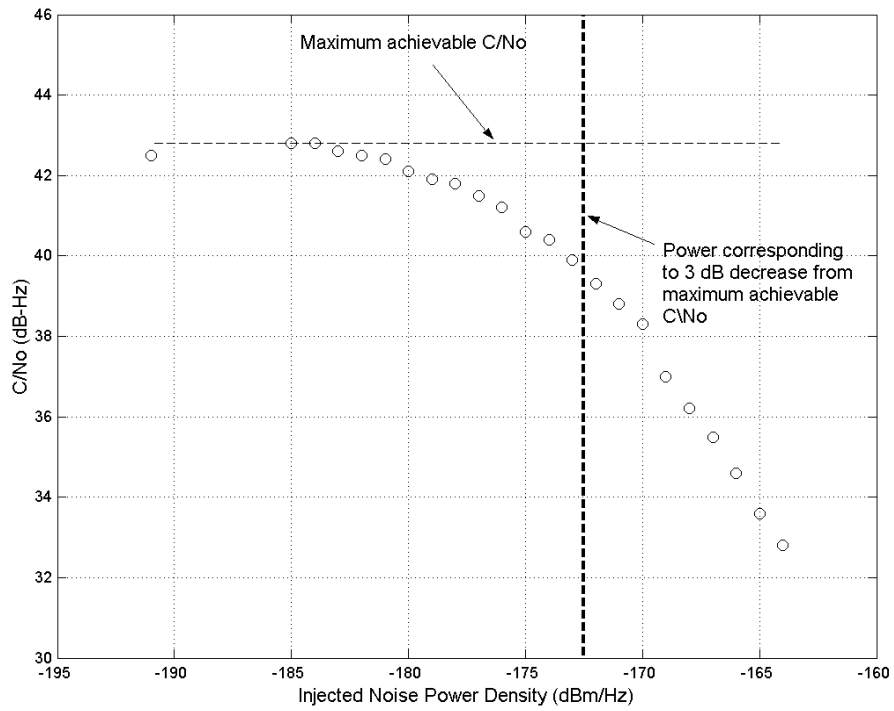

Figure 2.2. C/N_o receiver output versus injected noise power density for Rx 3.

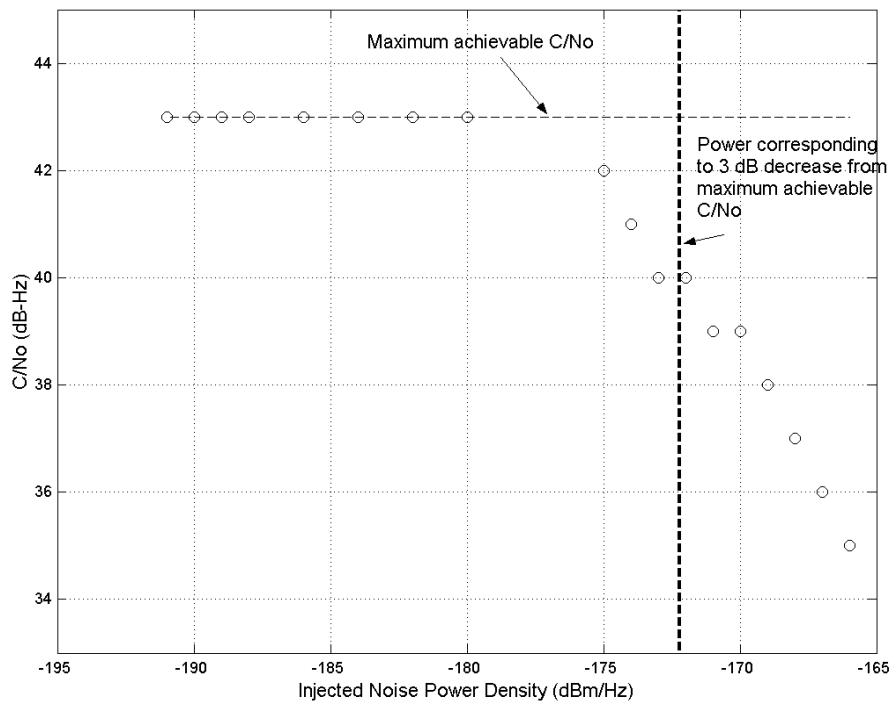

Figure 2.3. C/N_o receiver output versus injected noise power density for Rx 4.

3. RESULTS

This section discusses the GPS interference measurement results and summarizes trends.

3.1. Interference Measurement Results

Composite single-source results are provided to relate trends in GPS receiver performance degradation to UWB interference parameters (e.g., PRF, pulse spacing). Whenever relevant, gated UWB results are plotted directly below non-gated UWB results to demonstrate the effects of gating. The power of all gated signals is expressed as the average power during the on-time of the gated cycle. Table 3.1 gives a summary of the figures under discussion in this section.

Table 3.1. Composite Figure List

Interference	Rx 3			Rx 4		
	BL	CMC STD	RQT	BL	CMC STD	RQT
Noise	3.1, 3.2, 3.5	3.7	3.6	3.3, 3.4, 3.5	N/A	3.6
UPS	3.1, 3.2, 3.5	3.10	N/A	3.3, 3.4, 3.5	N/A	N/A
OOK	3.1, 3.2, 3.5	3.11	N/A	3.3, 3.4, 3.5	N/A	N/A
2% RRD	3.1, 3.2, 3.5	3.12	N/A	3.3, 3.4, 3.5	N/A	3.8
50% ARD	3.1, 3.2, 3.5	3.13	N/A	3.3, 3.4, 3.5	N/A	3.9

Composite plots comparing GPS performance metrics when exposed to various UWB signal types are provided in Figures 3.1 through 3.13. Figures 3.1 through 3.4 are composite graphs showing the BL point for each of the UWB permutations. For those cases where no BL point is displayed, the receiver never lost lock. Figure 3.5 compares BL for receivers 1, 3, and 4 in a bar graph. Rx 2 is not included because it has a fundamentally different architecture and mode of operation. For Figure 3.5, an absence of break lock is represented by bars at -60 dBm/20 MHz. Figures 3.6 and 3.7 show RQT and pseudorange (PSR) precision when each receiver is exposed only to Gaussian-noise interference. Comparison of the effects of PRF is shown in Figures 3.8 through 3.13, where RQT results for Rx 4 are given in Figures 3.8 and 3.9 and code-minus-carrier (CMC) residual-error standard deviation results for Rx 3 are given in Figures 3.10 through 3.13.

In addition to the composite plots, Appendix B provides a comprehensive set of plots – each set summarizing GPS performance degradation as a function of UWB interference type and UWB signal power. For Rx 3, each graph shows three measured parameters: BL point,

standard deviation of CMC error residual, and percentile plots for C/N_o . The percentiles represent the percentage of time the C/N_o was below the value represented on the ordinate. The BL point is represented by a thick vertical line on the right; if no vertical line is present, then BL did not occur. Only CMC standard deviation and C/N_o show correlation to interference power levels – unlike Rx 1 which also shows a correlation with the mean CMC. Because CMC data for Rx 3 is Gaussian in nature, percentile plots are not included.

For Rx 4, each graph shows, at most, three measured parameters: BL point, percentiles of C/N_o , and RQT (expressed as maximum and mean δ defined in section 5.2.2 of the parent report). UPS and OOK cases with a PRF greater than 100 kHz were not tested for RQT since reacquisition is highly dependent upon the position of the shifting GPS spectral lines. Because five satellites are required for this receiver (instead of the usual four), the specific satellites used for position and elevation determination are unknown; therefore, position precision information is not presented.

For both Rx 3 and Rx 4, the data shows periodic jumps in C/N_o (for example: Figures B.1.21 and B.2.32). For Rx 3 this occurs only with the dithered UWB signals, but for Rx 4 it appears to be independent of the interference type. These jumps are always discrete – 3 or 6 dB for Rx 3 and 8 dB for Rx 4. For Rx 3, there is a corresponding reduction in the CMC standard deviation. It is highly unlikely that these jumps in C/N_o are related to an attenuator malfunction since the variable attenuator consists of combinations of 1, 2, 4, 10, 20, and 40 dB attenuation. In Rx 4, these C/N_o anomalies are related to the level of the injected Gaussian noise but are independent of the UWB power level for both receivers. It was also noted that when the UWB interference is first applied to the receiver, the C/N_o is either elevated and remains elevated for the course of the measurement, or it is elevated for only about a minute and then returns to a lower C/N_o for the remainder of the testing. Thus, the values show discrete jumps despite the fact that they represent a mean.

3.2. Summary of Results

Trends in receiver response related to the characteristics of the UWB signals themselves, such as PRF, pulse spacing, and gating are discussed in Section 6.3.2 of the parent report and apply, as well, to the receivers measured for this report. These are summarized in the following statements:

1. UWB signals with uniform pulse spacing have spectral lines, and when these spectral lines lie within the GPS band, there is potential for alignment with spectral lines of the GPS signal. This alignment is particularly invasive; impact is directly related to the magnitude of the specific GPS and UWB spectral lines for which alignment occurs.
2. On-off-keying, since it too has spectral lines, can have a significant impact on GPS receiver degradation. However, the effects of OOK are less detrimental than the

effects of UPS because the OOK spectral power is distributed between spectral lines and a noise component; hence the power contained in each line is less.

3. Dithering can reduce the impact of UWB interference on a GPS receiver by reducing or eliminating spectral lines in the GPS band.
4. Higher PRFs have a greater interference effect for two reasons. One reason is that, for those cases with spectral lines, greater power is gathered into each spectral line. The other reason is that higher PRFs result in a greater percentage of time for which the pulses are present.
5. Gating reduces the interference impact on receivers for two reasons. One reason is that the power of individual spectral lines is spread out into multiple lines, thus reducing the power contained in any single line. The other reason is that, for signals of equal gated-on power density, the percentage of time the pulses are present is less with gating.

There are several other trends worth noting in addition to those reported in the parent report.

1. Because Gaussian noise and UWB signals combine to make up the total contribution of interference, the lower the BL point for the noise only case, the lower the UWB power level required to affect receiver performance in these measurements.
2. Figure 3.5 shows that Rx 1 and Rx 3 are very similar with regard to BL points. Rx 4, however, shows a greater vulnerability than either Rx 1 or Rx 3 with regard to gated and non-gated dithered pulses with a PRF of 1 MHz or greater. Rx 4 is also less vulnerable to non-gated lined interference (UPS and OOK) than Rx 1 and Rx 3.
3. As shown in Figures B.1.2 through B.1.17, Rx 3 shows very little variation in CMC standard deviation prior to BL for the pulsed signals with spectral lines. However, for dithered UWB signals (1-MHz PRF or greater) and noise there is a significant increase in standard deviation with increasing interference power levels.
4. While Rx 1 and Rx 2 have shown elevations in RQT when UWB power levels are as much as 10 to 20 dB below the BL point, Rx 4 shows an elevation in RQT no greater than 6 dB below the BL point and on some occasions, no more than 1 dB below the BL point (see Figures B.2.18 through B.2.33).

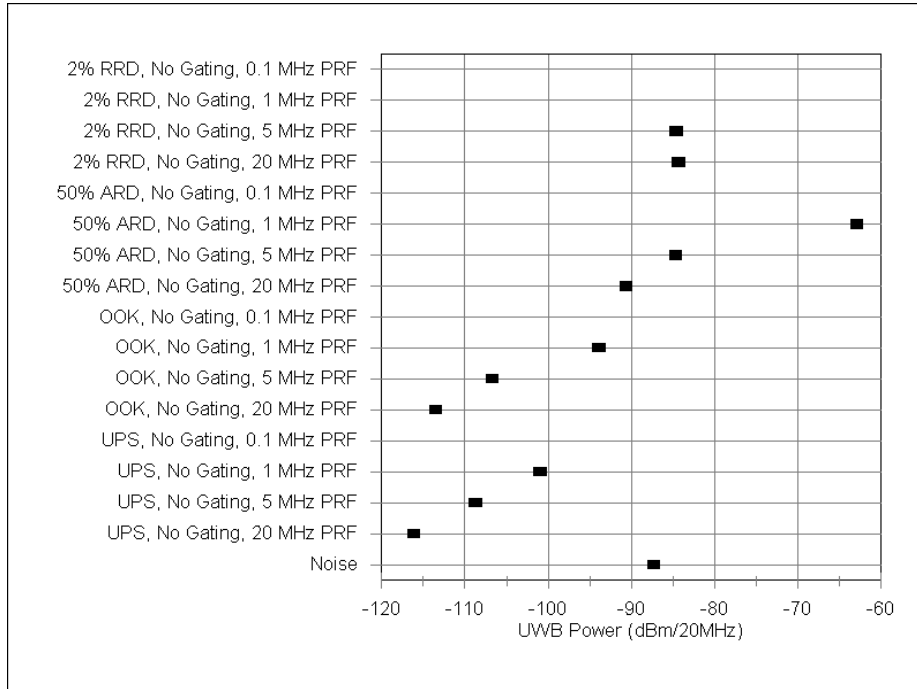

Figure 3.1. Non-gated UWB signal vs. signal power at BL (Rx 3).

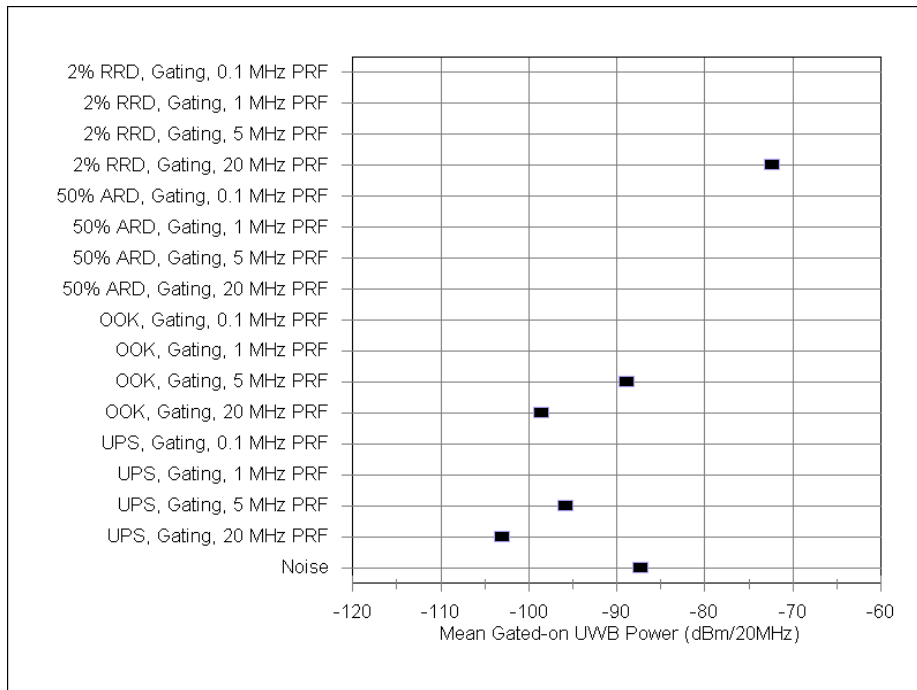

Figure 3.2. Gated UWB signal vs. signal power at BL (Rx 3).

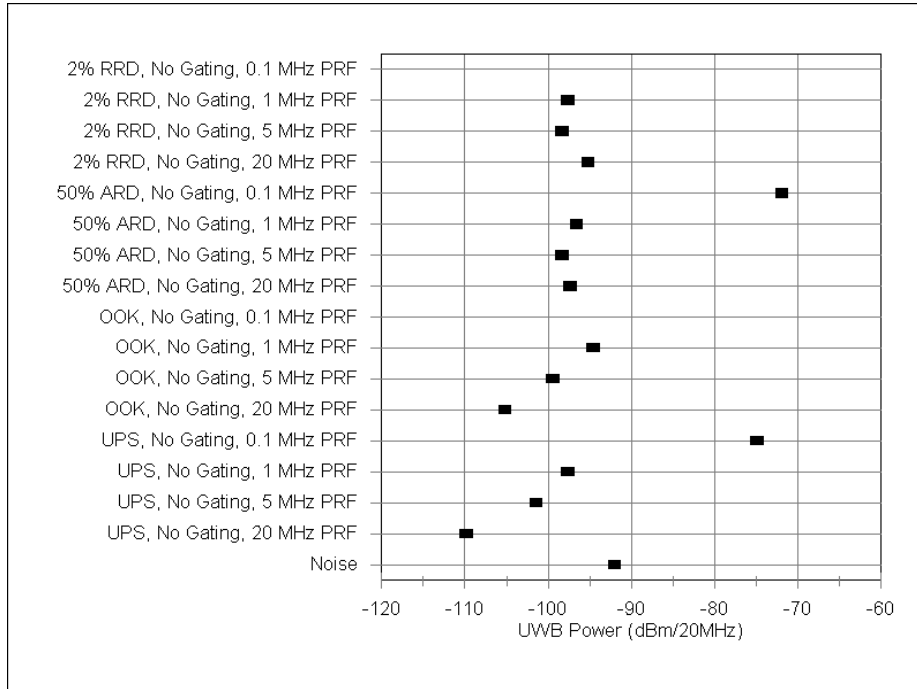

Figure 3.3. Non-gated UWB signal vs. signal power at BL (Rx 4).

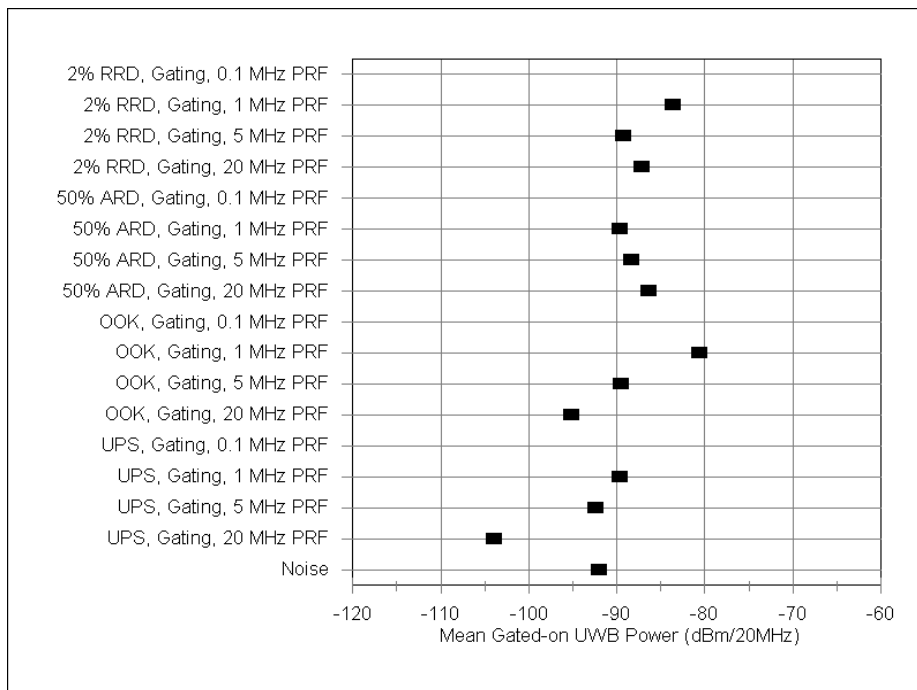

Figure 3.4. Gated UWB signal vs. signal power at BL (Rx 4).

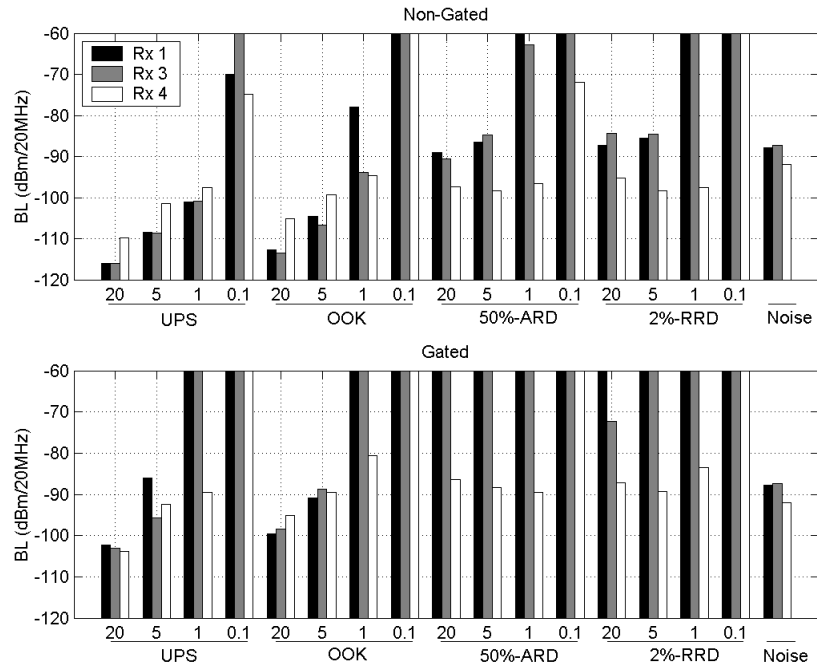

Figure 3.5. UWB signal vs. signal power at BL, comparing Rx 1, Rx 3, and Rx 4.

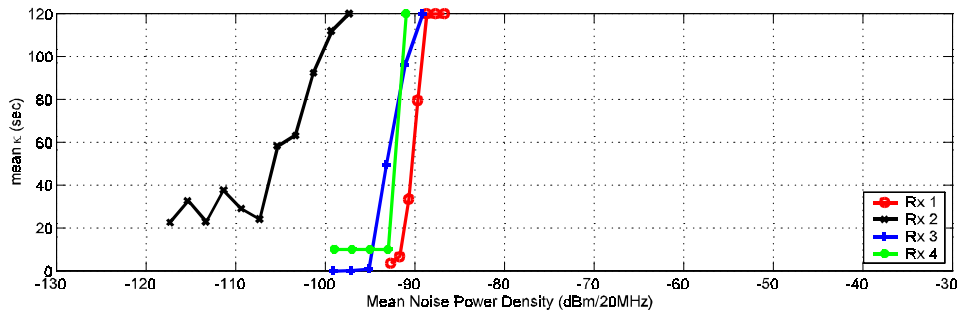

Figure 3.6. RQT of GPS receivers when exposed to Gaussian-noise interference.

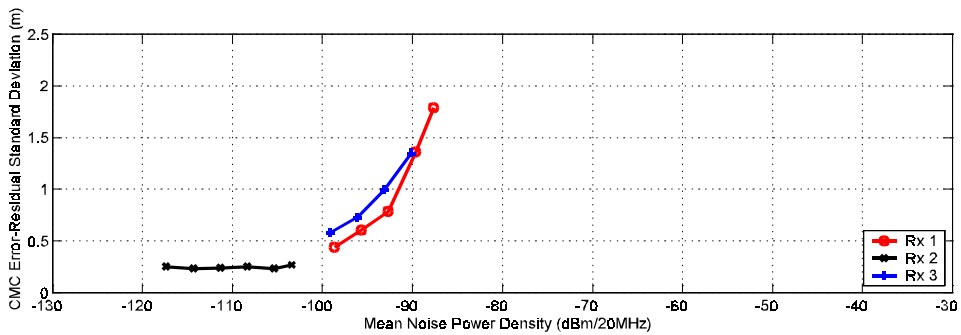

Figure 3.7. PSR precision of GPS receivers when exposed to Gaussian-noise interference.

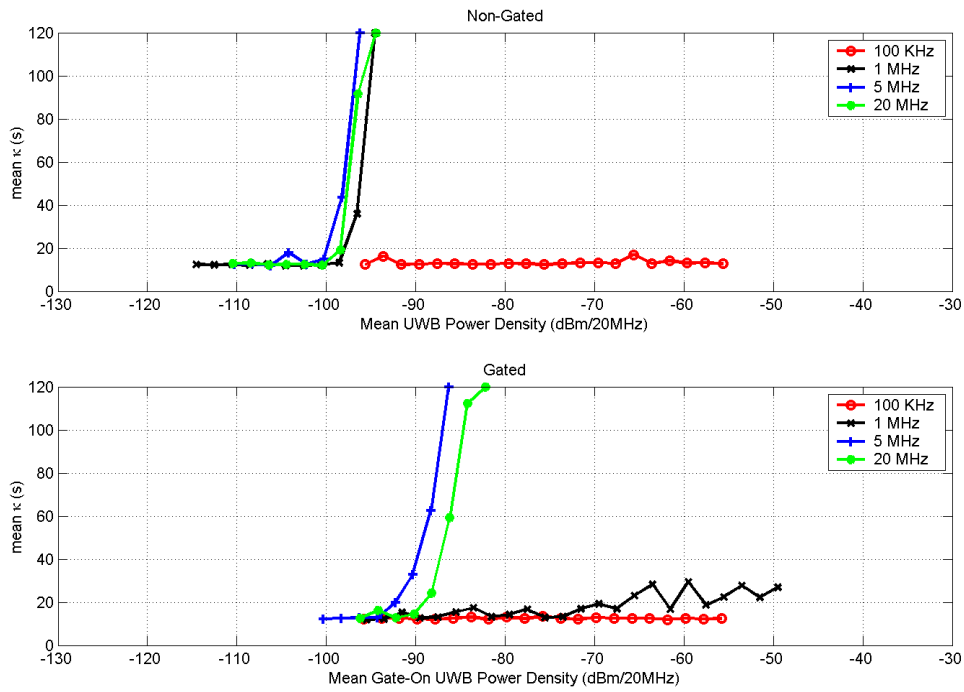

Figure 3.8. RQT of Rx 4 when exposed to 2%-RRD UWB interference.

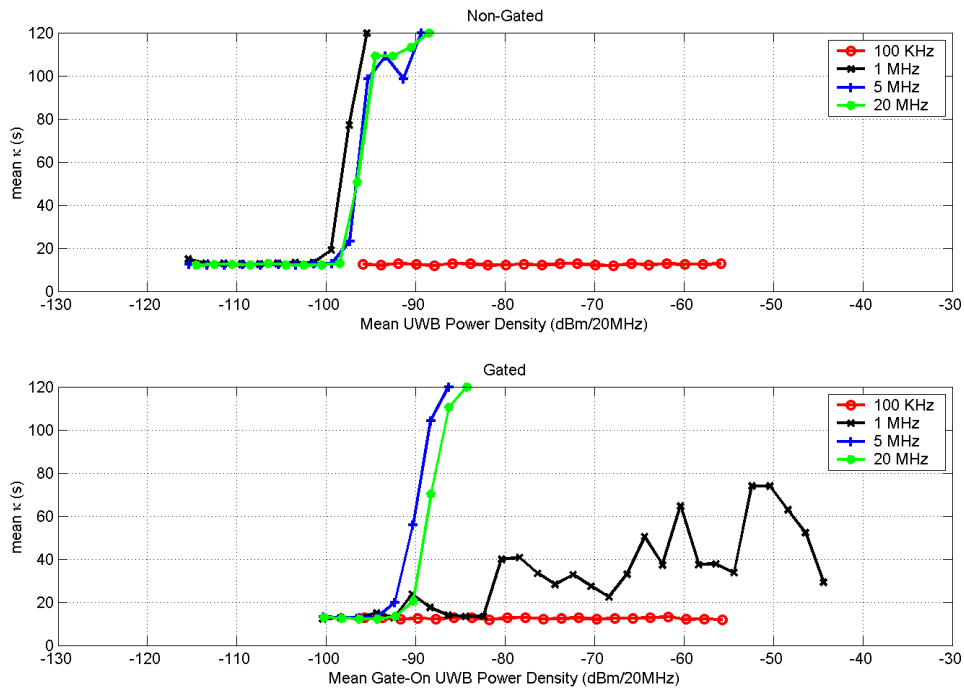

Figure 3.9. RQT of Rx 4 when exposed to 50%-ARD UWB interference.

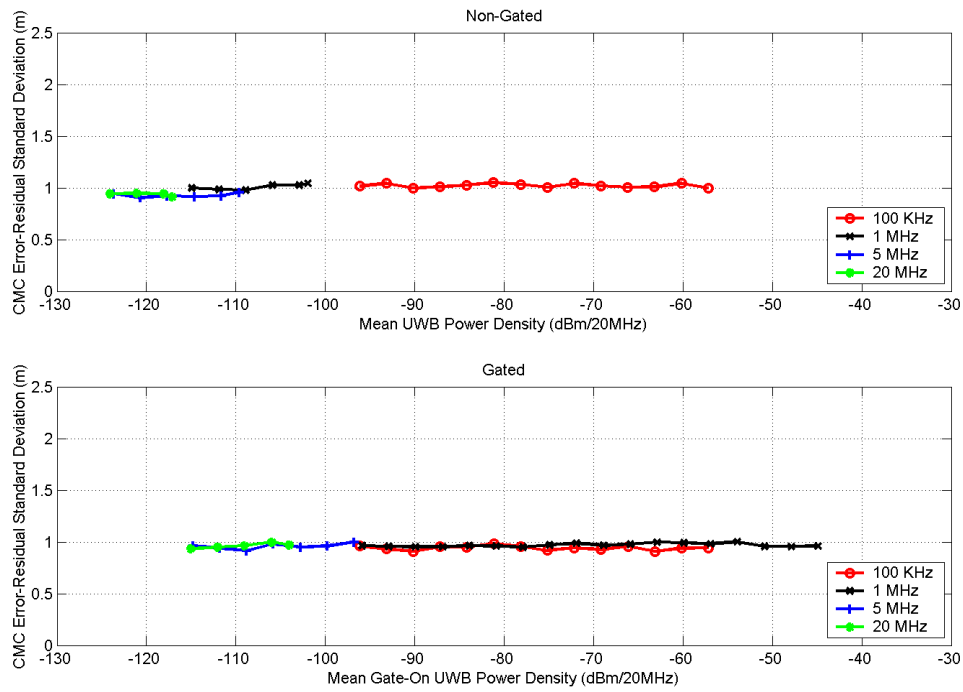

Figure 3.10. PSR precision of Rx 3 when exposed to UPS UWB interference.

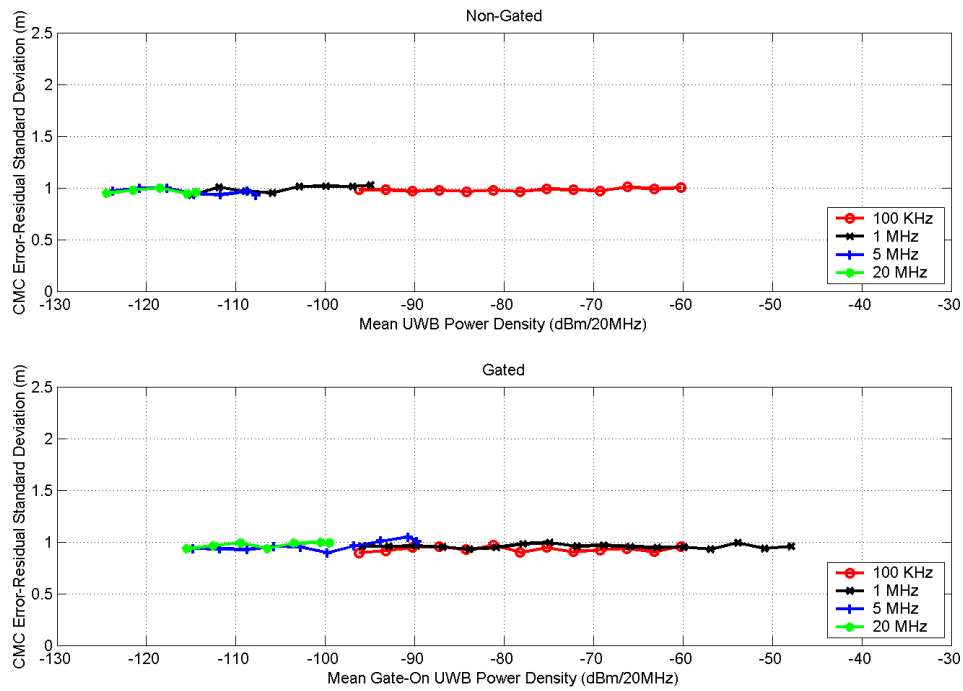

Figure 3.11. PSR precision of Rx 3 when exposed to OOK UWB interference.

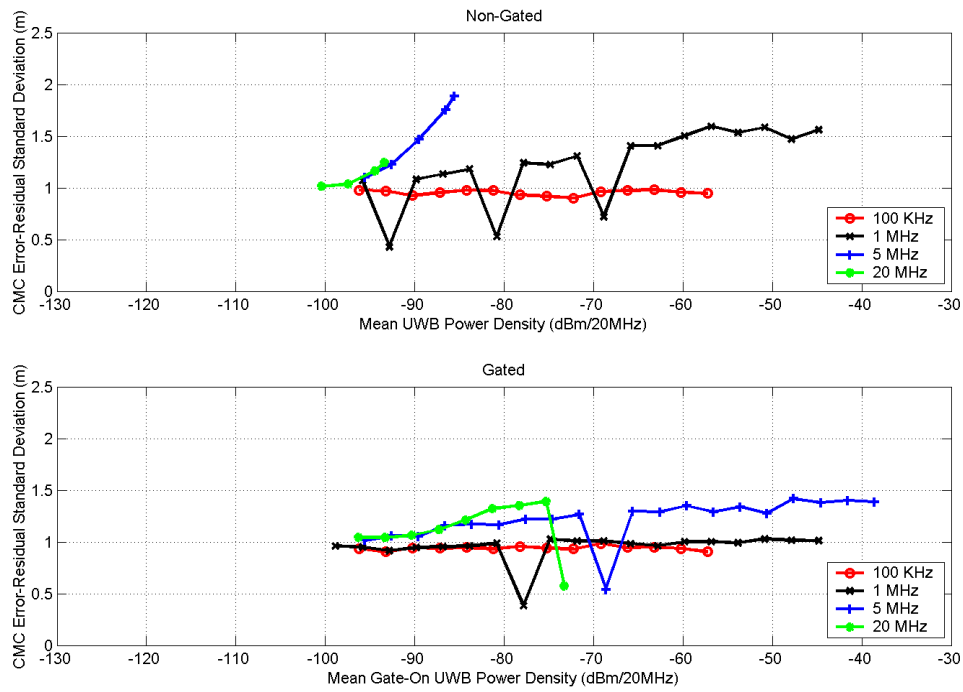

Figure 3.12. PSR precision of Rx 3 when exposed to 2%-RRD UWB interference.

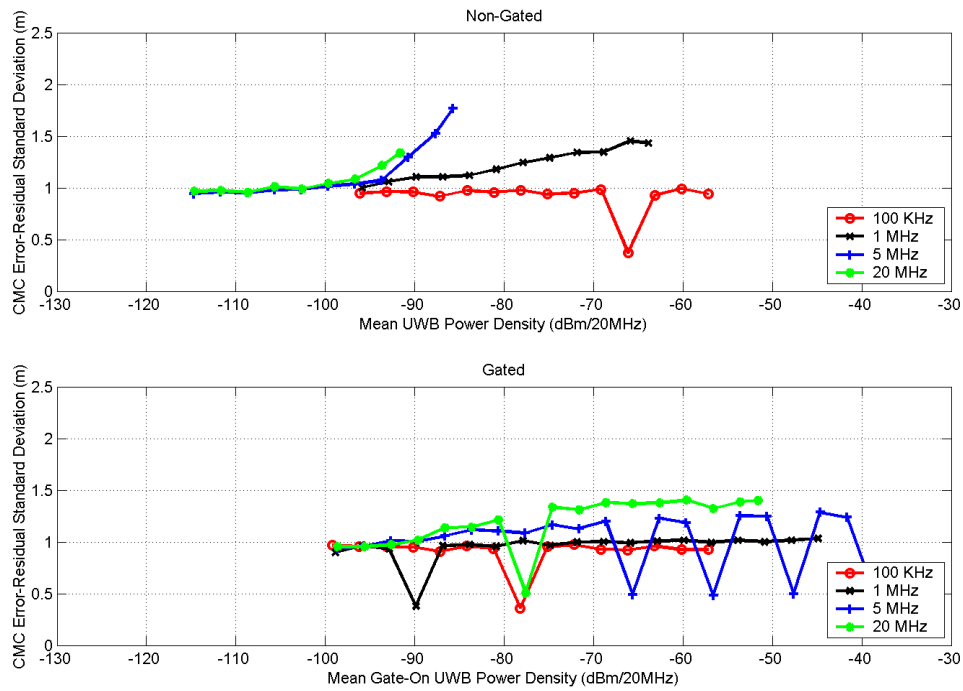

Figure 3.13. PSR precision of Rx 3 when exposed to 50%-ARD UWB interference.

4. CONCLUSIONS

This addendum to NTIA Report 01-384 further investigates potential interference to GPS. Two additional receivers were tested, one a narrow-correlator (Rx 3) and the other a TSO-C129a aviation receiver (Rx 4).

The GPS signal was generated by a GPS constellation simulator. A select group of UWB signals were generated with a programmable arbitrary waveform generator and custom hardware which triggered a sequence of UWB pulses. Signals with uniform pulse spacing (UPS), on-off-keying (OOK), 2% relative reference dithering (RRD), and 50% absolute reference dithering (ARD) at 0.1, 1.0, 5.0, and 20.0 MHz pulse repetition frequencies (PRF) were used. These signals were also gated at 100% and 20% duty cycles.

Two independent operational tests, break lock (BL) and reacquisition time (RQT), measure the receiver's ability to maintain and reacquire lock over a range of UWB signal powers. The BL and RQT metrics bracket a region of GPS receiver performance degradation. The RQT determines the lower bound where the interference begins to have a detrimental effect on the operation of the receiver. The BL point sets the upper bound where operation is impossible. Rx 4 was tested for both of these parameters; however, Rx 3 was not tested for RQT.

Observables were retrieved from the GPS receiver during the BL tests to further demonstrate GPS performance degradation. For Rx 3, pseudorange and carrier phase measurements were used to evaluate the effects of UWB interference on CMC standard deviation. C/N_o as determined by the receiver was retrieved from both Rx 3 and Rx 4.

While there are variations in receiver responses, there are some consistent patterns between receivers that can be noted. Rx 2 deviates the most from the other three since, unlike its counterparts, it is a high precision GPS receiver with a low tolerance for cycle slip. The other three receivers show remarkably similar patterns with some slight variations. All three have the same basic BL response to the different UWB signal types (e.g., UWB signals with spectral lines cause BL at lower interference power levels, as do signals with higher PRFs; gating increases the required gated on-time power required for BL). Rx 4, however, shows a greater sensitivity to dithered UWB interference which causes BL to occur at lower interference power levels relative to Rx 1 or Rx 3.

There is a wide range of UWB signal types with a wide range of effects on GPS receivers. Depending upon the bandwidth of the receiver, the PRF, the pulse spacing mode, and the presence of gating, the UWB signal can be impulsive, or Gaussian noise-like, or even sinusoidal. With 100-kHz PRF, UWB interference limited to any practical GPS receiver bandwidth is impulsive and rarely caused loss of satellite lock. UWB signals with a 20-MHz PRF and no dithering have strong spectral lines and were most invasive to the receivers. These spectral lines caused receivers to lose lock at UWB power levels as low as 20 dB

below the Gaussian noise power (both measured in a 20-MHz bandwidth). In some cases, the receivers showed significant performance degradation even if they never lost satellite lock. For instance, some gated UWB signals caused an elevated RQT for UWB signal power as low as 40 dB below the highest setting in the BL test, even though BL never occurred.

5. REFERENCES

- [1] J.R. Hoffman, M.G. Cotton, R.J. Achatz, R.N. Statz, and R.A. Dalke, "Measurements to determine potential interference to GPS receivers from ultrawideband transmission systems," NTIA Report 01-384, Feb. 2001.
- [2] *Notice of Proposed Rulemaking*, ET Dkt. 98-153 (rel. May 11, 2000), Federal Register, June 14, 2000, vol. 65, No. 115), pp. 37332 - 37335.
- [3] Minimum Operational Performance Standards for Airborne Supplemental Navigation Equipment Using Global Positioning System (*GPS*), RTCA DO-208, July 1991, Appendix F, p. 1.

This Page Intentionally Left Blank

This Page Intentionally Left Blank

APPENDIX A: HARDWARE SPECIFICATION

A.1 RF Components

A1 - Fixed Coaxial Attenuator

Manufacturer: Midwest Microwave
Model: ATT-0444-03-SMA-02
Frequency range: 0 - 18 GHz
Attenuation: 3 dB

A2 - Fixed Coaxial Attenuator (3x)

Manufacturer: Midwest Microwave
Model: ATT-0444-10-SMA-02
Frequency range: 0 - 18 GHz
Attenuation: 10 dB

B - DC Blocking Capacitor

Manufacturer: Picosecond Pulse Labs
Model: 5502C
BW(-3dB): 14 GHz
Rise time: 24 ps
Delay: 154 ps
Insertion loss: < 0.5 dB @ 2 GHz

C - 3 way (0 degree) Power Combiner

Manufacturer: Midwest Microwave
Model: PWD-5520-03-SMA-79
Frequency range: 0.5 - 2.0 GHz
Isolation: 15-dB minimum
Amplitude balanced: 0.5 dB
Phase balanced: 5 degrees
Insertion loss: 5 dB @ 1575 MHz

DC - Directional Coupler

Manufacturer: Mini-Circuits
Model: ZFDC-10-5
Frequency range: 1 - 2000 MHz
Coupling: 10.8 dB
Main line loss: 1.8-dB max
Directivity: 30 dB

F3 - Band Pass Filter

Manufacturer: TTE
Type: 315-1575.42M-24M-50-SMA
Center frequency (f_0): 1575.42 MHz
Passband bandwidth: $0.015 f_0$, minimum
Insertion loss at f_0 : < -2 dB

F5 - Band Pass Filter

Manufacturer: TTE
Type: 305-1575.42M-50M-50-SMA
Center frequency (f_0): 1575.42 MHz
Passband bandwidth: $0.043 f_0$
Insertion loss at f_0 : < -0.3 dB

G1 - Medium Power Amplifier

Manufacturer: Mini-Circuits
Model: ZFL-2000
Frequency range: 10 - 2000 MHz
Gain at 1575.42MHz : 27 dB
Noise figure: 7 dB
Maximum power: +16dBm

G2 - Low Noise Amplifier

Manufacturer: Mini-Circuits
Model: ZHL-1217HLN
Frequency range: 1200 - 1700 MHz
Gain at 1575.42MHz : 39 dB (measured)
Noise figure: 1.5 dB
Maximum power: +26 dBm

ND2 - Noise Diode

Manufacturer: Noise / Com, Inc
Model: NC3108A
Serial No. E574
ENR: 27.02 dB @ 1.0 GHz
ENR: 26.65 dB @ 2.0 GHz

S - 4 way, 0 deg Power Splitter

Manufacturer: Mini-Circuits
Model: ZA4PD-2
Frequency range: 1 - 2 GHz
Isolation: 25 dB
Insertion loss: 6 dB

SW - Coaxial Switch

Manufacturer: Dow-Key Microwave

Model: 401-2308

RF circuit: SPDT

Frequency range: 0 - 26.5 GHz

T - Termination, SMA, 50 Ohm, 1 Watt

Manufacturer: Inmet

Model: TS180M

Frequency range: 0 - 18 GHz

VA1 - Step Attenuator (Programmable)

Manufacturer: Hewlett Packard

Model: HP8495G

Frequency range: 0 - 4 GHz

Attenuation range: 0 - 70 dB, 10-dB step

VA2 - Step Attenuator (Programmable)

Manufacturer: Hewlett Packard

Model: HP8494H

Frequency range: 0 - 18 GHz

Attenuation range: 0 - 11 dB, 1-dB step

VA3 - Step Attenuator (Programmable)

Manufacturer: Hewlett Packard

Model: HP8496G

Frequency range: 0 - 4 GHz

Attenuation range: 0 - 110 dB, 10-dB step

VA4 - Step Attenuator (Programmable)

Manufacturer: Hewlett Packard

Model: HP8494G

Frequency range: 0 - 4 GHz

Attenuation range: 0 - 11 dB, 1-dB step

VA5 - Step Attenuator (Manual)

Manufacturer: Hewlett Packard

Model: HP8494B

Frequency range: 0 - 18 GHz

Attenuation range: 0 - 11 dB, 1-dB step

VA6 - Step Attenuator (Manual)

Manufacturer: Hewlett Packard
Model: HP8496B
Frequency range: 0 - 18 GHz
Attenuation range: 0 - 110 dB, 10-dB step

VA7 - Step Attenuator (Manual)

Manufacturer: Midwest Microwave
Model: 1044
Frequency range: 0 - 12 GHz
Attenuation range: 0 - 60 dB, 10-dB step and 0 - 10 dB, 1-dB step

A.2 Arbitrary Waveform Generator and Pulse Generator

AWG - Arbitrary Waveform Generator

Manufacturer: Sony / Tektronix
Model: AWG520
Rise time (10 - 90%): # 2.5 ns (amplitude > 1.0 V)
1.5 ns (amplitude # 1.0 V)
Fall time (10 - 90%): # 2.5 ns (amplitude > 1.0 V)
1.7 ns (amplitude # 1.0 V)
Bandwidth: 500 MHz
Phase noise: # -90 dBc/Hz (10-kHz offset)
Pulse width: 10-ns minimum

PG1 - UWB Pulse Generators

Manufacturer: Time Domain
Model: Pulser PG-2000
Unit serial number: NTIA-004
Impulse amplitude (50- Ω load): 5.8V
Impulse rise time (10 - 90%): 200 ps
Impulse fall time (90 - 10%): 416 ps
Impulse width (50%): 521 ps
Max. trigger rate: 40 Mpps

A.3 GPS Receivers

Rx 3 - Dynamics (sets carrier tracking bandwidth) = air
Carrier smoothing = 2s
External clock = disabled
Elevation mask = 0°
Clock adjust (clock drift model) = disabled

Position averaging = disabled
GPS channel configuration = L1/L2
Differential GPS protocol = disabled

Rx 4 - Settings fixed and compliant with TSO-C129a aviation receiver specifications.

This Page Intentionally Left Blank

This Page Intentionally Left Blank

APPENDIX B: GPS PERFORMANCE MEASUREMENT RESULTS

Each figure in this appendix illustrates a comprehensive summary of measured GPS performance degradation for a given receiver exposed to a UWB signal permutation. Not all scenarios were measured, as summarized in Table B.1.

Table B.1. Single-Source UWB Interference Measurement Figure List

Interference Spacing / PRF (MHz) / DC (%)	Rx 3		Rx 4	
	BL	RQT	BL	RQT
Gaussian noise	B.1.1	3.6 (Section 3)	B.2.1	B.2.1
UPS / 20 / 100, 20	B.1.2, 3	N/A	B.2.2, 3	N/A
UPS / 5 / 100, 20	B.1.4, 5	N/A	B.2.4, 5	N/A
UPS / 1 / 100, 20	B.1.6, 7	N/A	B.2.6, 7	N/A
UPS / 0.1 / 100, 20	B.1.8, 9	N/A	B.2.8, 9	B.2.8, 9
OOK / 20 / 100, 20	B.1.10, 11	N/A	B.2.10, 11	N/A
OOK / 5 / 100, 20	B.1.12, 13	N/A	B.2.12, 13	N/A
OOK / 1 / 100, 20	B.1.14, 15	N/A	B.2.14, 15	N/A
OOK / 0.1 / 100, 20	B.1.16, 17	N/A	B.2.16, 17	B.2.16, 17
50% ARD / 20 / 100, 20	B.1.18, 19	N/A	B.2.18, 19	B.2.18, 19
50% ARD / 5 / 100, 20	B.1.20, 21	N/A	B.2.20, 21	B.2.20, 21
50% ARD / 1 / 100, 20	B.1.22, 23	N/A	B.2.22, 23	B.2.22, 23
50% ARD / 0.1 / 100, 20	B.1.24, 25	N/A	B.2.24, 25	B.2.24, 25
2% RRD / 20 / 100, 20	B.1.26, 27	N/A	B.2.26, 27	B.2.26, 27
2% RRD / 5 / 100, 20	B.1.28, 29	N/A	B.2.28, 29	B.2.28, 29
2% RRD / 1 / 100, 20	B.1.30, 31	N/A	B.2.30, 31	B.2.30, 31
2% RRD / 0.1 / 100, 20	B.1.32, 33	N/A	B.2.32, 33	B.2.32, 33

B.1. Narrow Correlator Receiver (Rx 3) Results

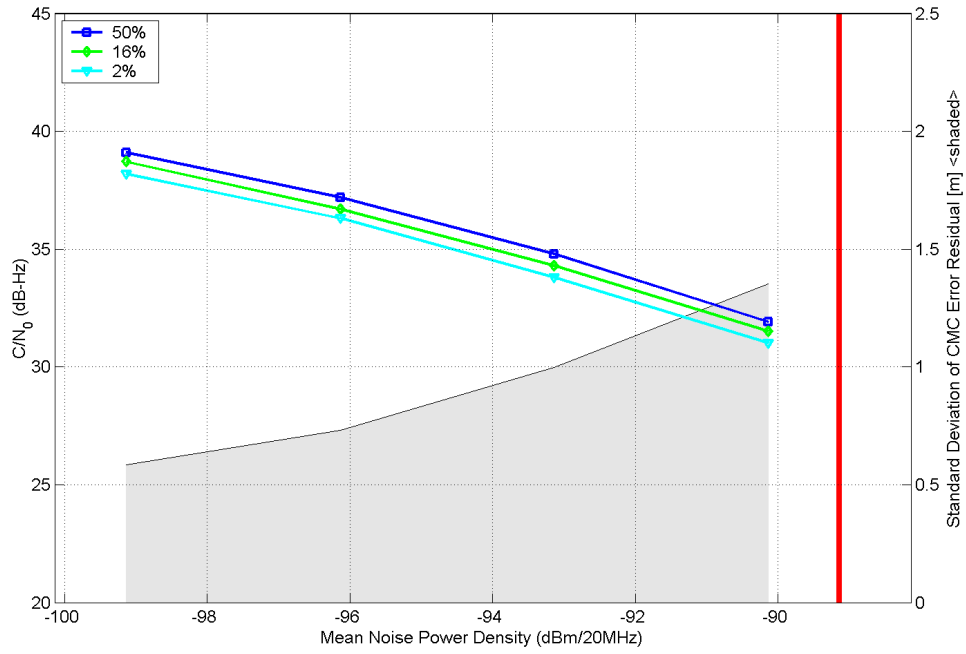

Figure B.1.1. Measured GPS parameters (Rx 3) as a function of Gaussian-noise interference.

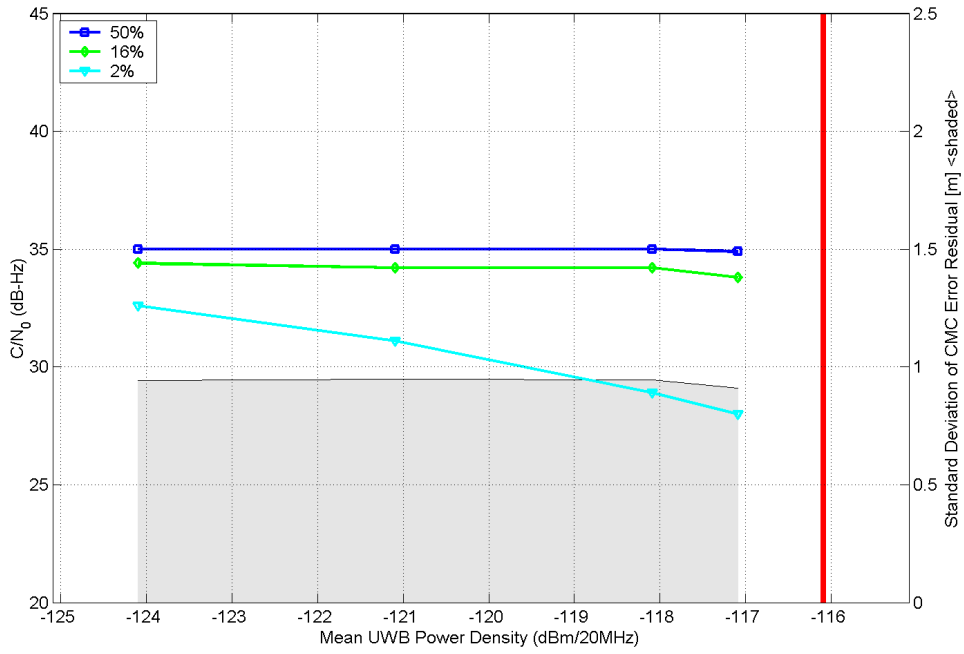

Figure B.1.2. Measured GPS parameters (Rx 3) as a function of 20-MHz PRF, UPS, non-gated UWB interference.

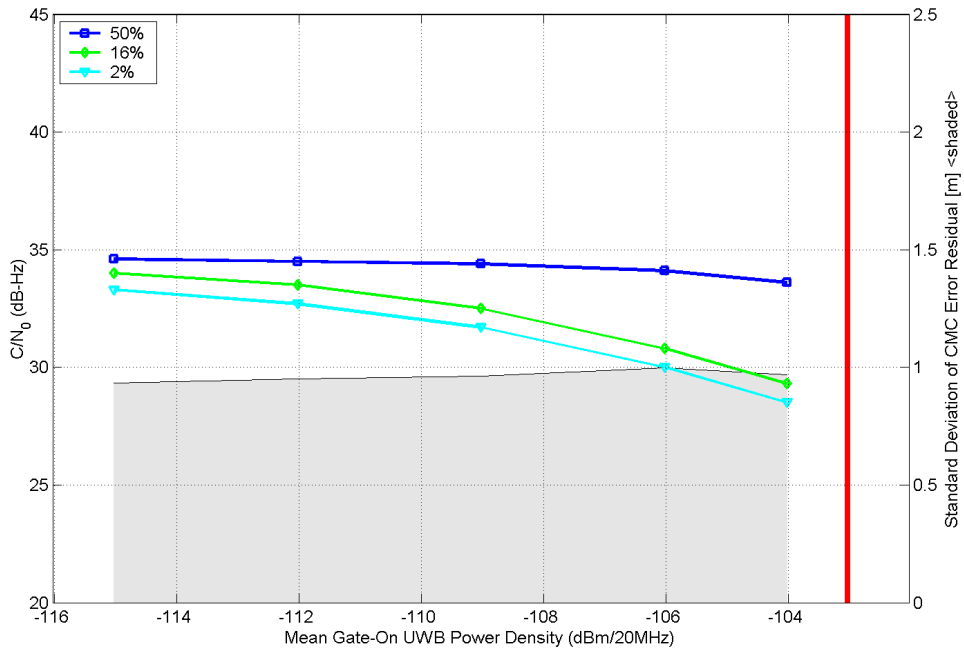

Figure B.1.3. Measured GPS parameters (Rx 3) as a function of 20-MHz PRF, UPS, gated (20% duty cycle) UWB interference.

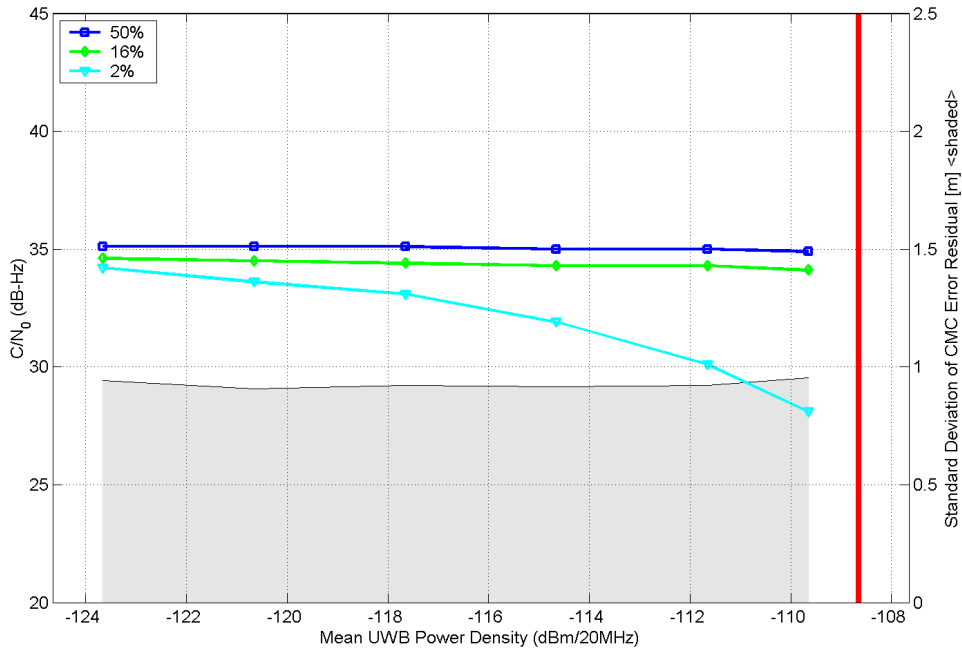

Figure B.1.4. Measured GPS parameters (Rx 3) as a function of 5-MHz PRF, UPS, non-gated UWB interference.

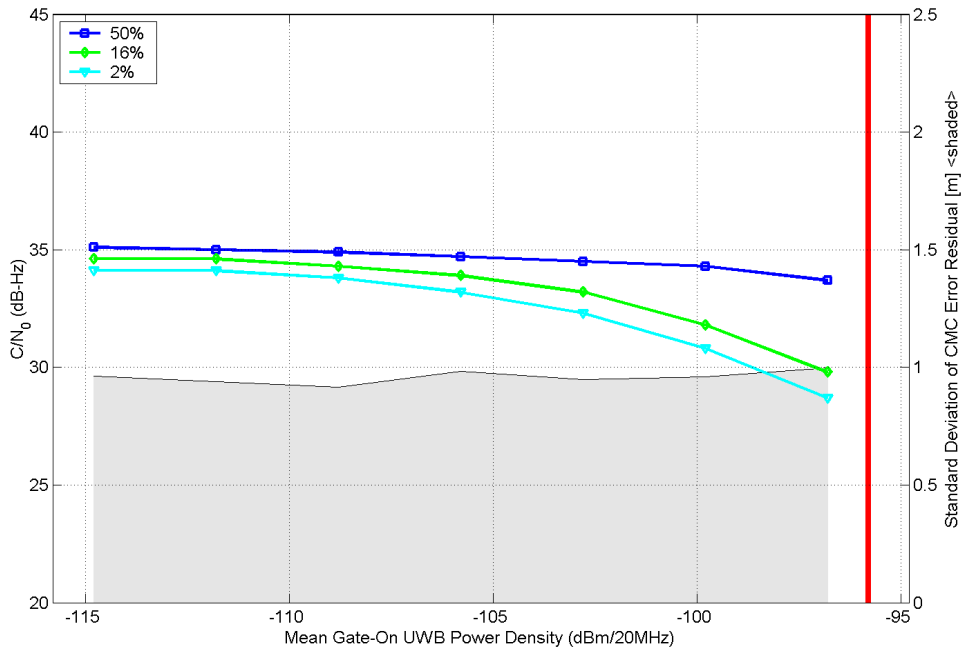

Figure B.1.5. Measured GPS parameters (Rx 3) as a function of 5-MHz PRF, UPS, gated (20% duty cycle) UWB interference.

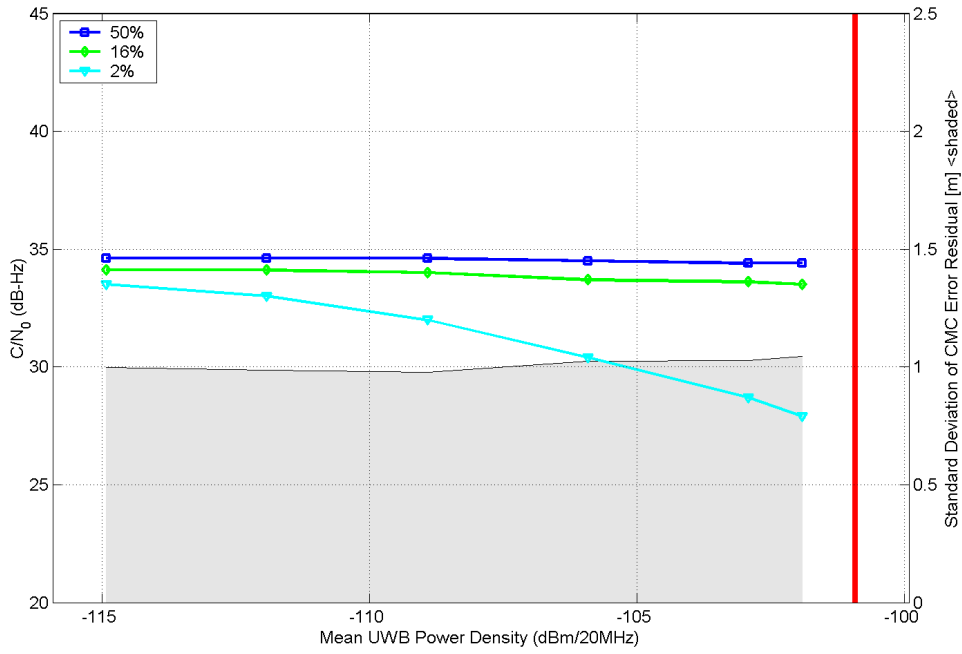

Figure B.1.6. Measured GPS parameters (Rx 3) as a function of 1-MHz PRF, UPS, non-gated UWB interference.

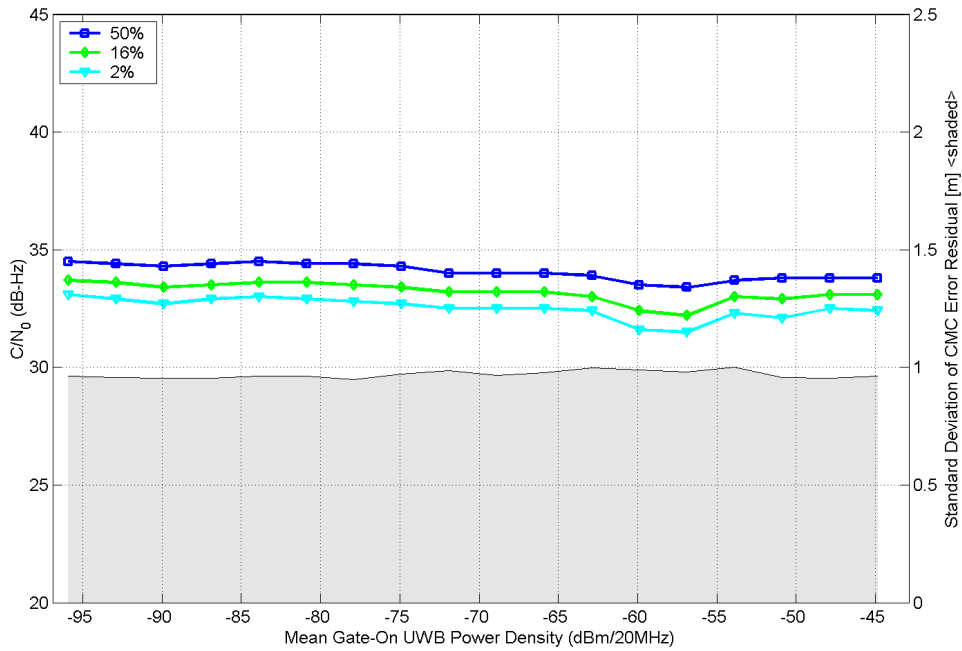

Figure B.1.7. Measured GPS parameters (Rx 3) as a function of 1-MHz PRF, UPS, gated (20% duty cycle) UWB interference.

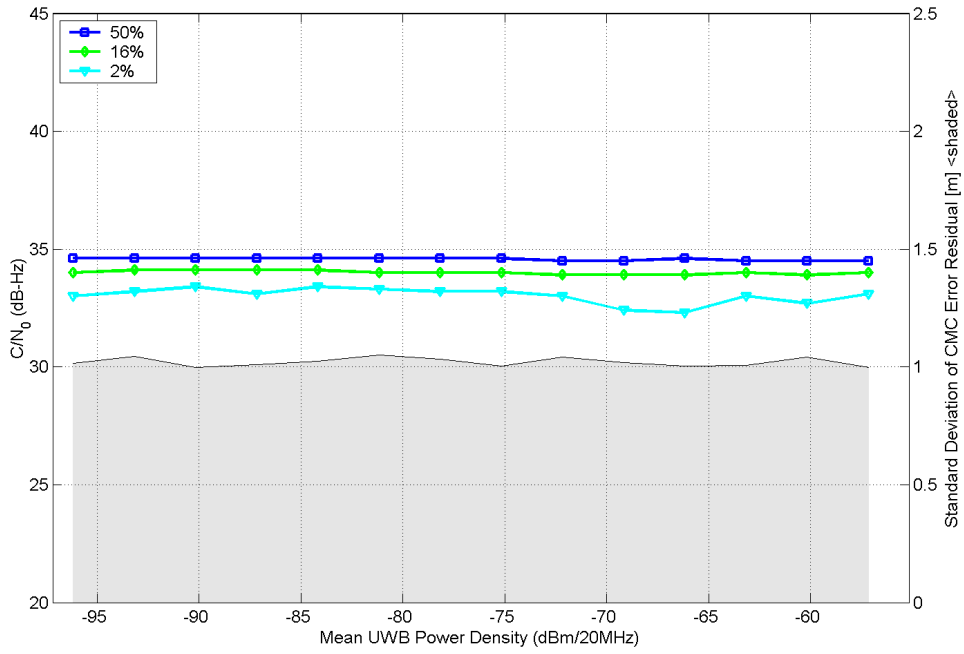

Figure B.1.8. Measured GPS parameters (Rx 3) as a function of 0.1-MHz PRF, UPS, non-gated UWB interference.

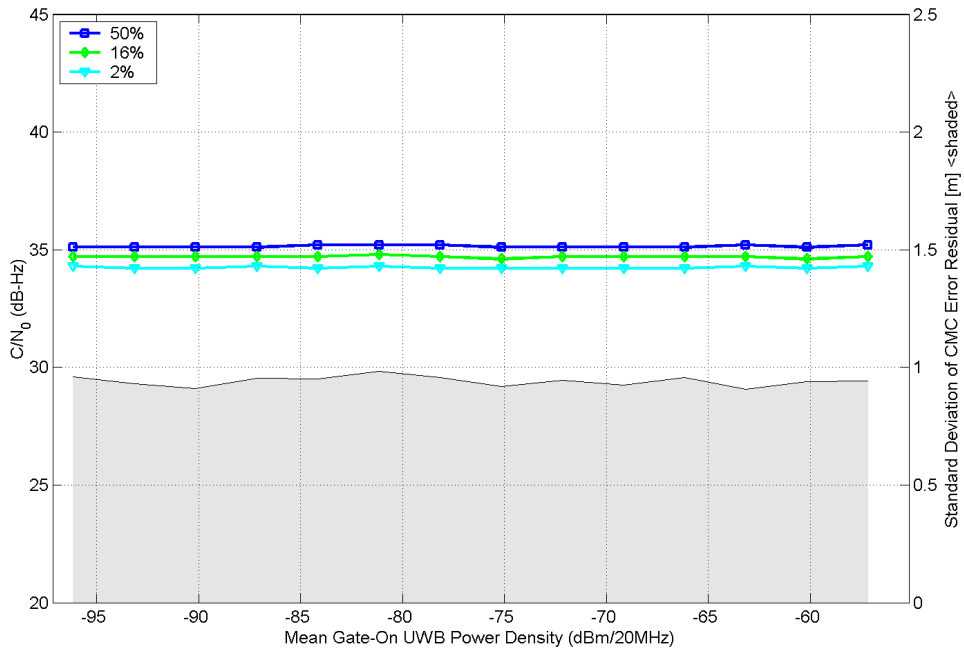

Figure B.1.9. Measured GPS parameters (Rx 3) as a function of 0.1-MHz PRF, UPS, gated (20% duty cycle) UWB interference.

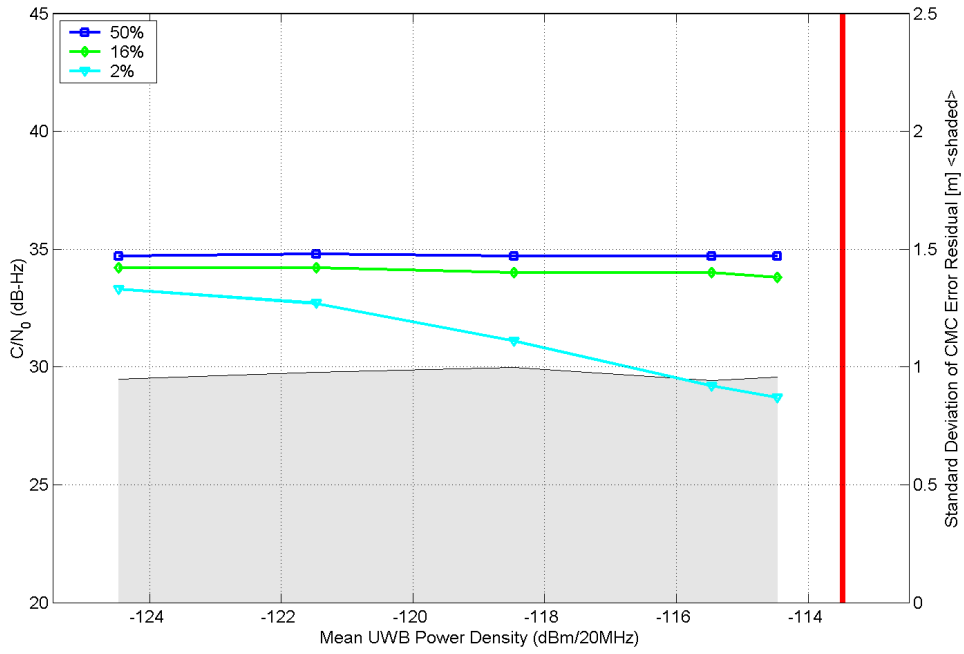

Figure B.1.10. Measured GPS parameters (Rx 3) as a function of 20-MHz PRF, OOK, non-gated UWB interference.

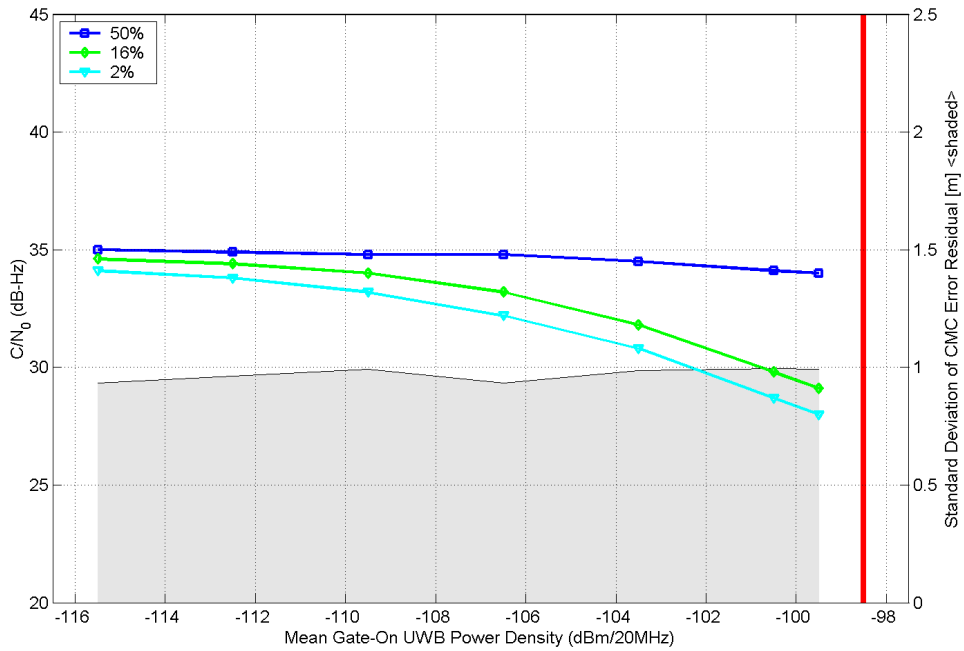

Figure B.1.11. Measured GPS parameters (Rx 3) as a function of 20-MHz PRF, OOK, gated (20% duty cycle) UWB interference.

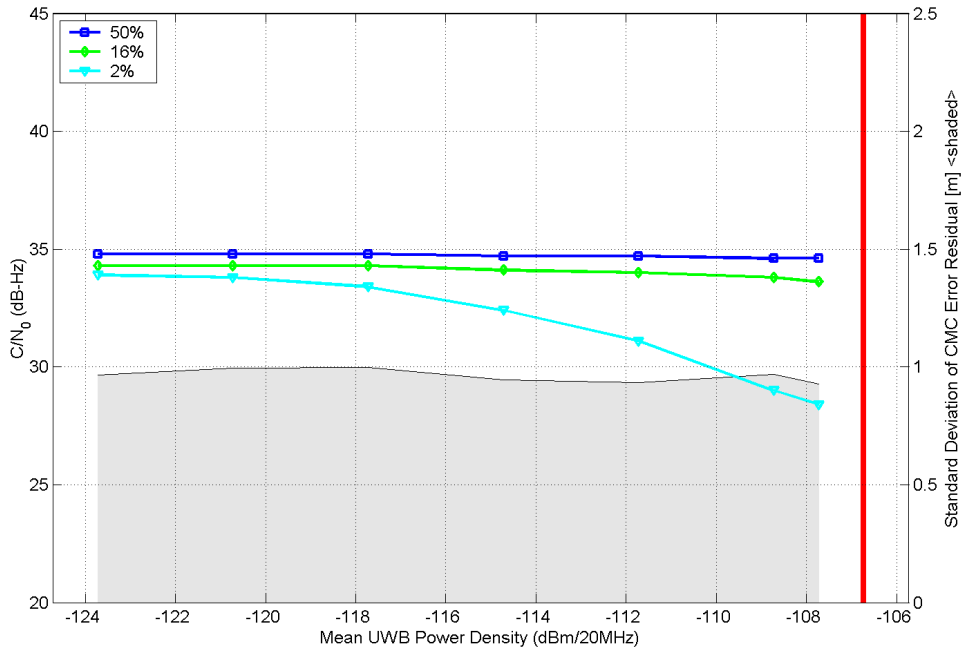

Figure B.1.12. Measured GPS parameters (Rx 3) as a function of 5-MHz PRF, OOK, non-gated UWB interference.

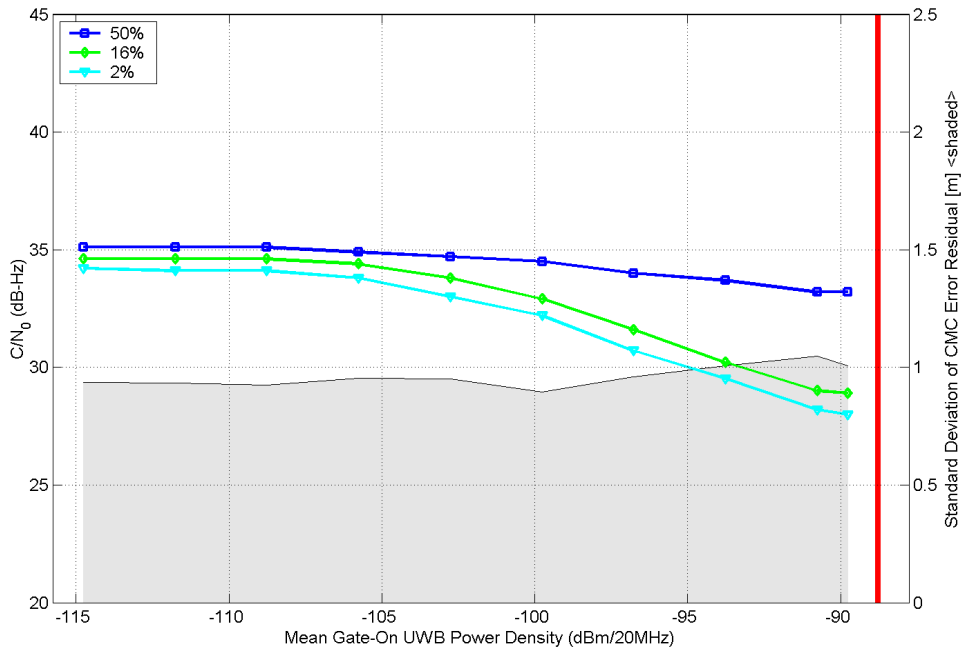

Figure B.1.13. Measured GPS parameters (Rx 3) as a function of 5-MHz PRF, OOK, gated (20% duty cycle) UWB interference.

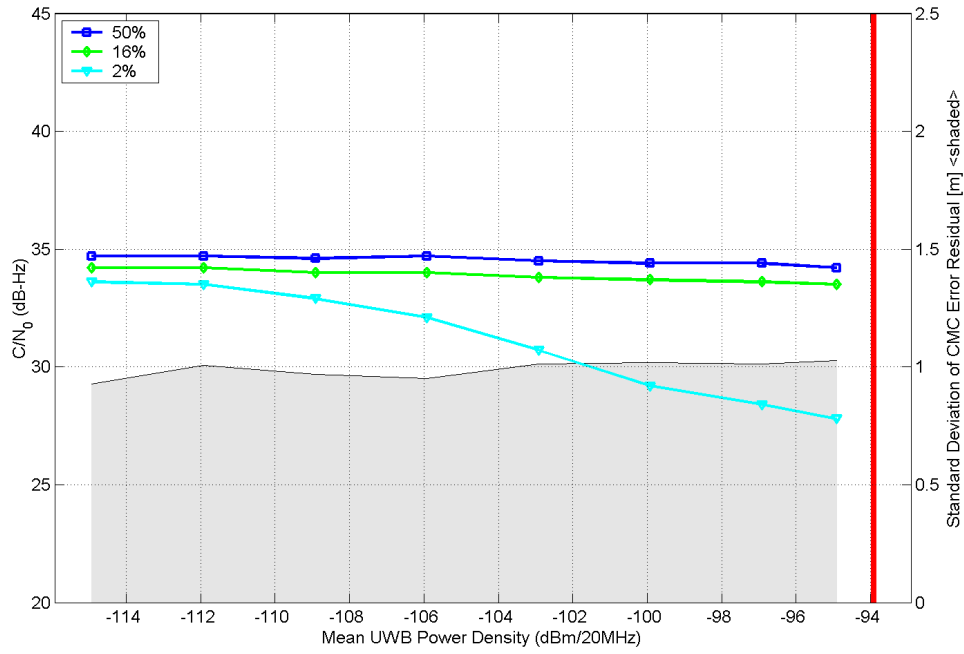

Figure B.1.14. Measured GPS parameters (Rx 3) as a function of 1-MHz PRF, OOK, non-gated UWB interference.

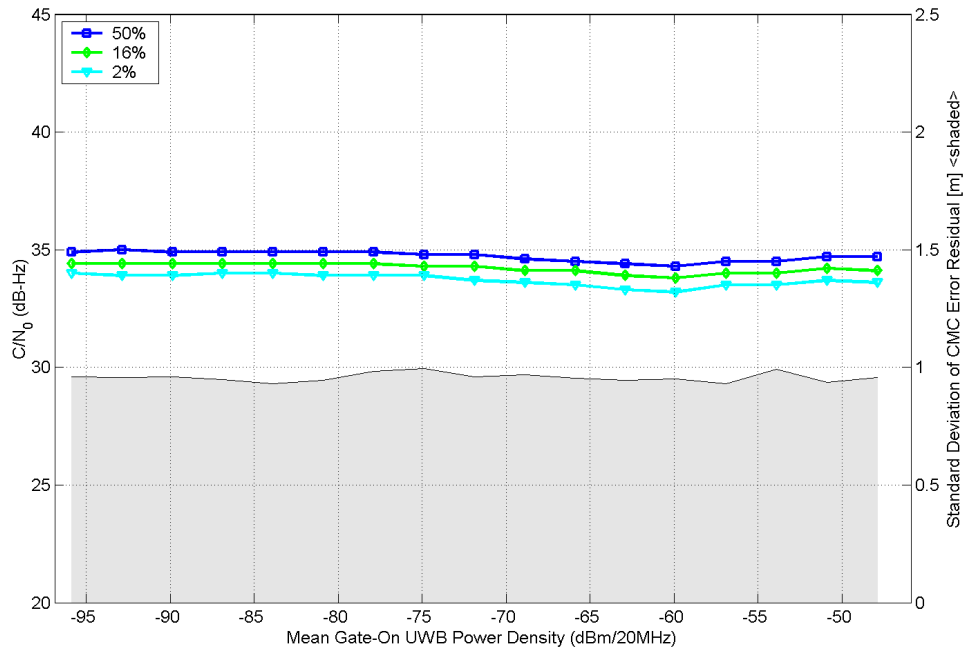

Figure B.1.15. Measured GPS parameters (Rx 3) as a function of 1-MHz PRF, OOK, gated (20% duty cycle) UWB interference.

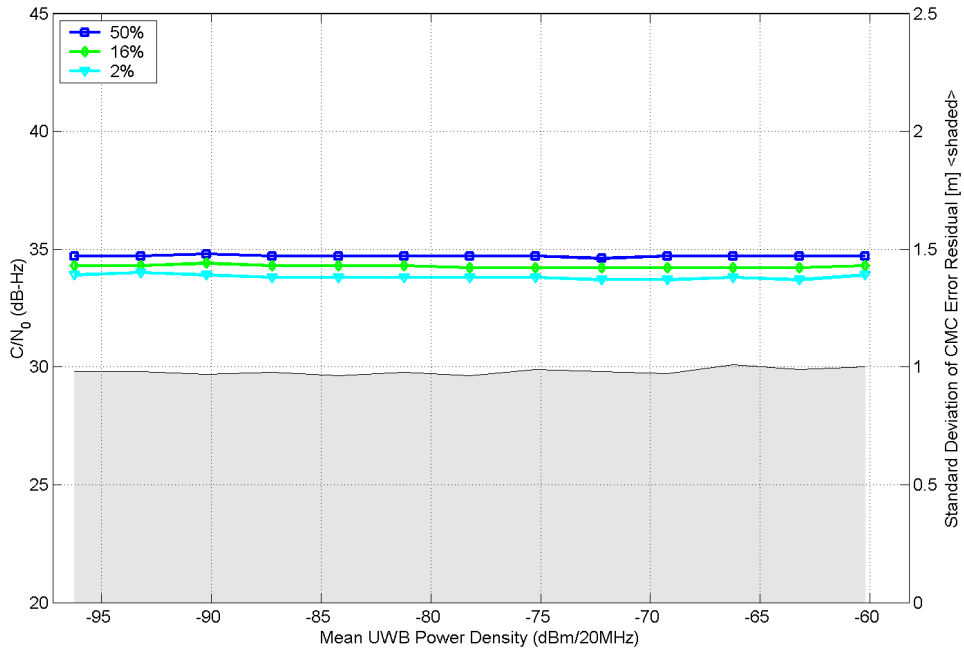

Figure B.1.16. Measured GPS parameters (Rx 3) as a function of 0.1-MHz PRF, OOK, non-gated UWB interference.

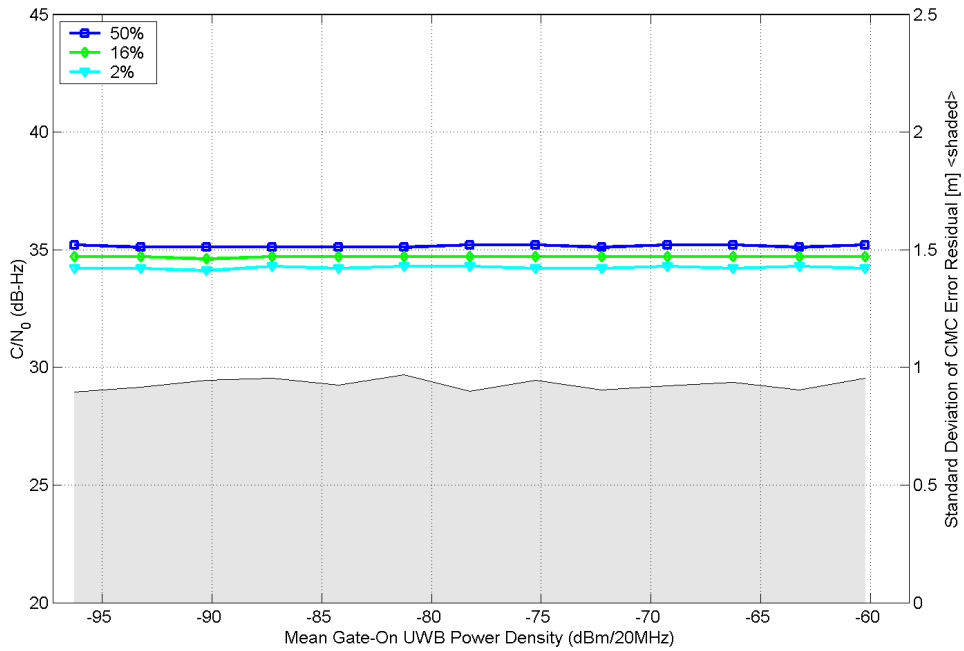

Figure B.1.17. Measured GPS parameters (Rx 3) as a function of 0.1-MHz PRF, OOK, gated (20% duty cycle) UWB interference.

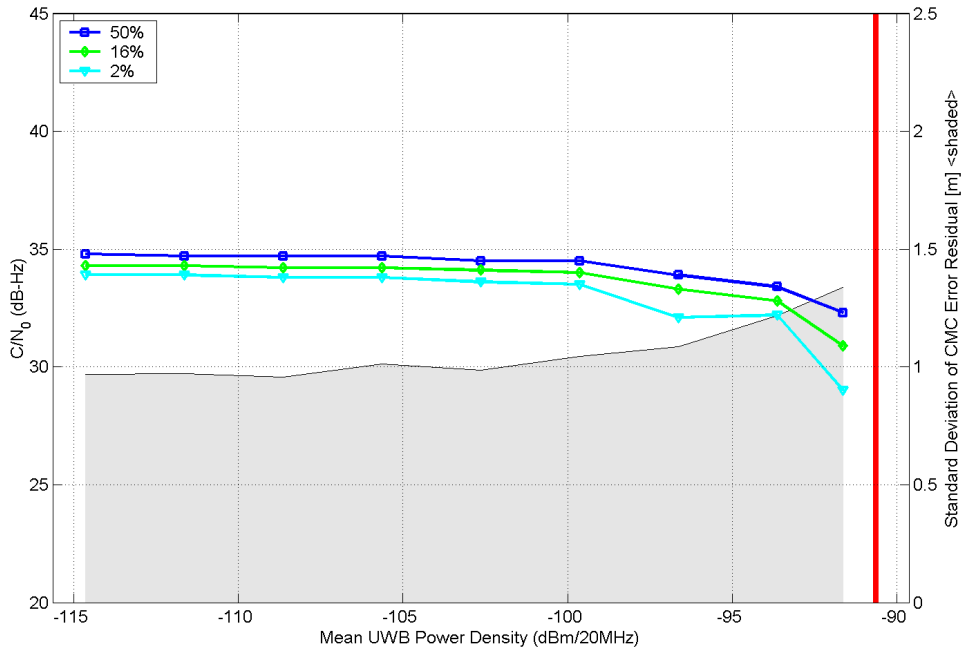

Figure B.1.18. Measured GPS parameters (Rx 3) as a function of 20-MHz PRF, 50%-ARD, non-gated UWB interference.

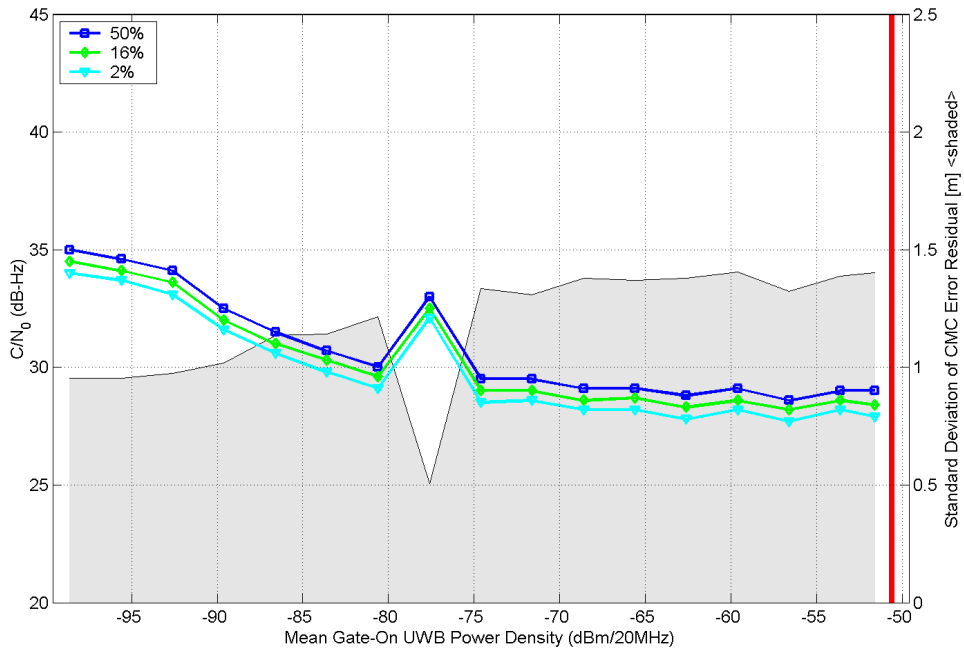

Figure B.1.19. Measured GPS parameters (Rx 3) as a function of 20-MHz PRF, 50%-ARD, gated (20% duty cycle) UWB interference.

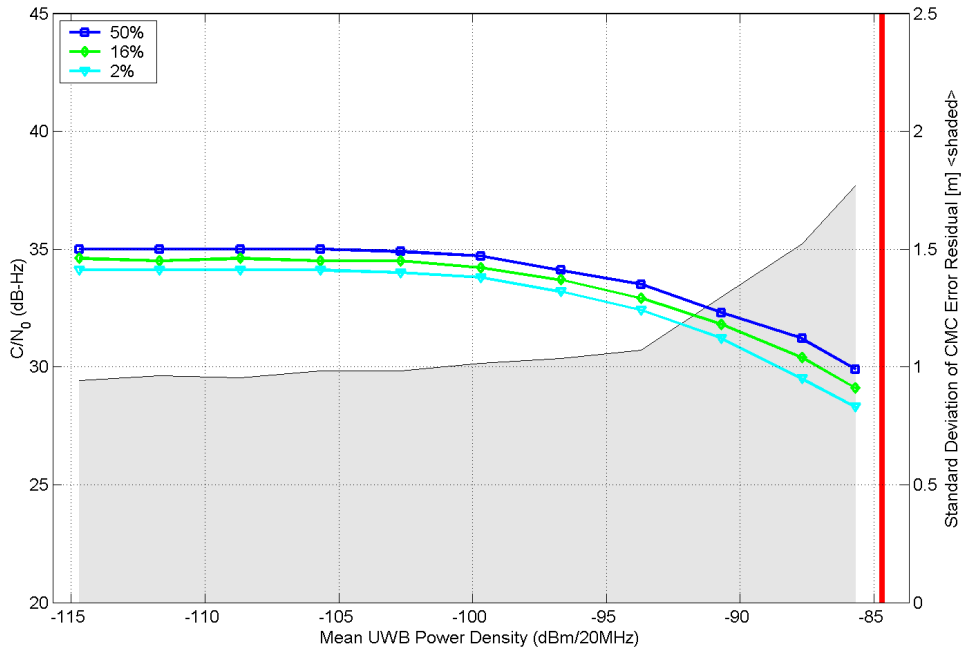

Figure B.1.20. Measured GPS parameters (Rx 3) as a function of 5-MHz PRF, 50%-ARD, non-gated UWB interference.

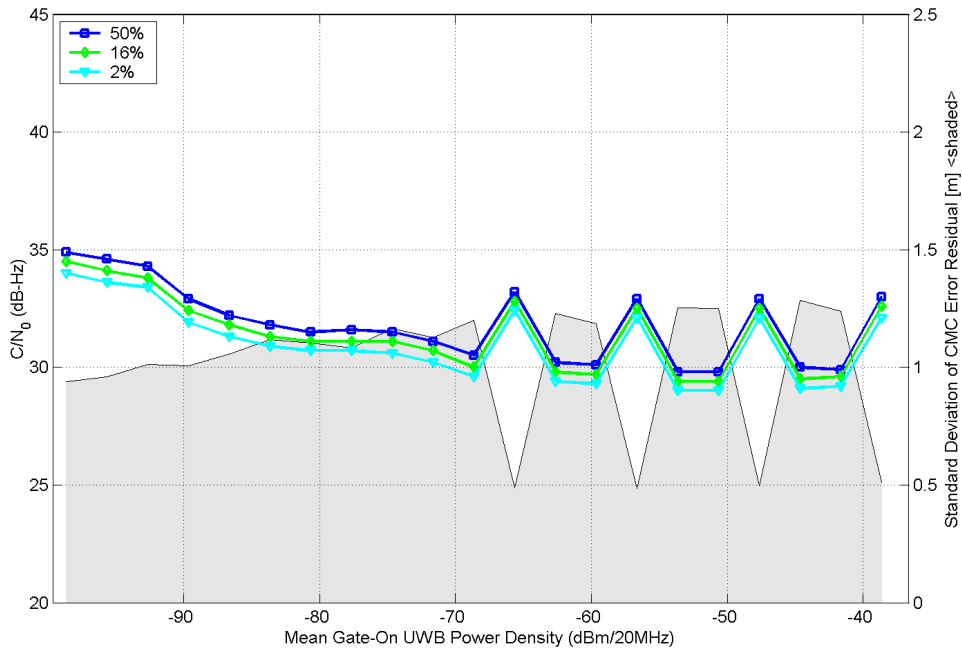

Figure B.1.21. Measured GPS parameters (Rx 3) as a function of 5-MHz PRF, 50%-ARD, gated (20% duty cycle) UWB interference.

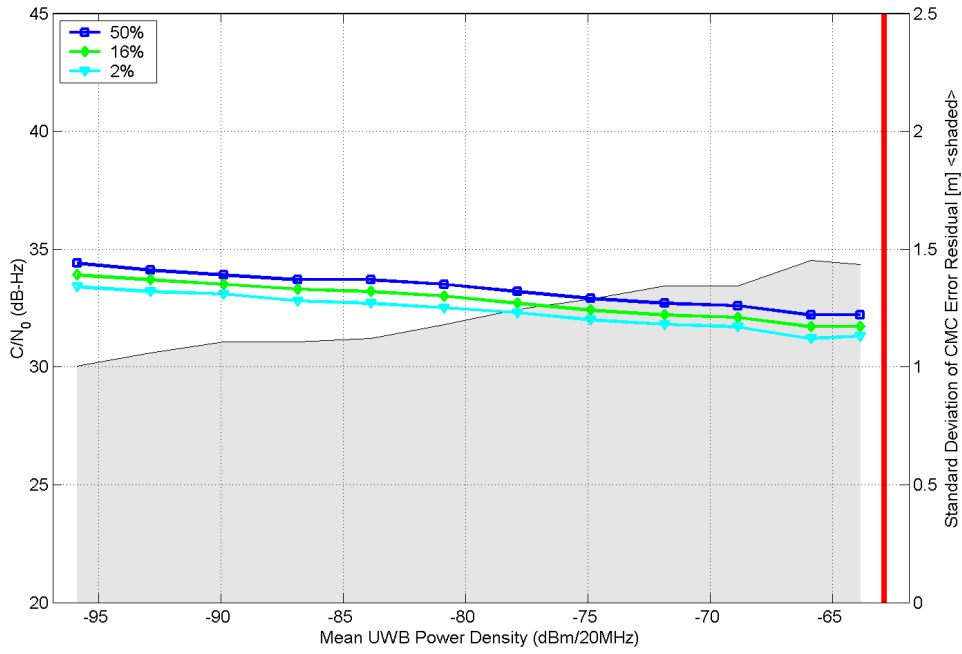

Figure B.1.22. Measured GPS parameters (Rx 3) as a function of 1-MHz PRF, 50% ARD, non-gated UWB interference.

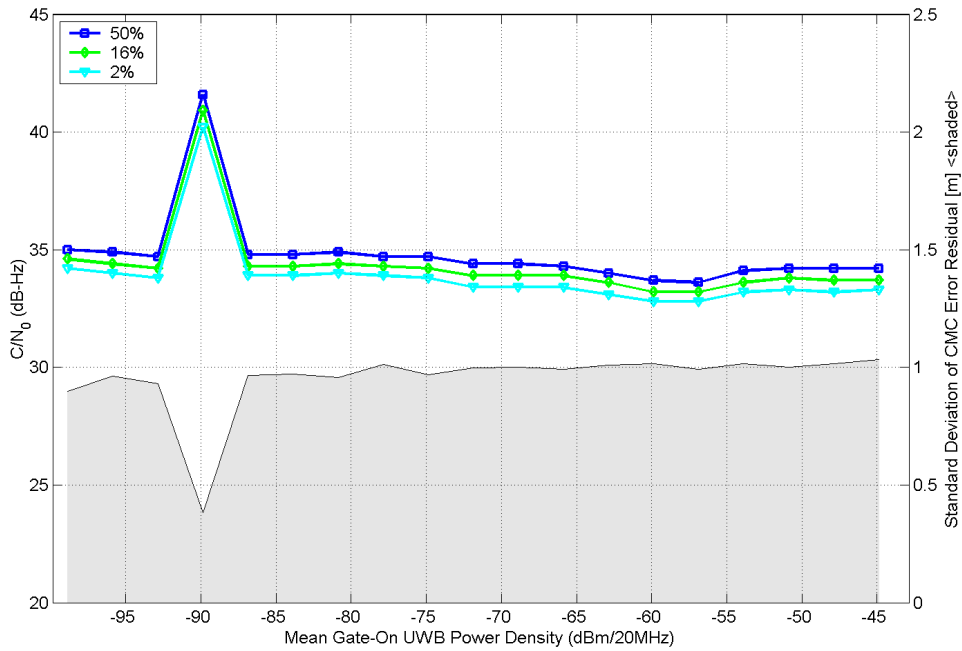

Figure B.1.23. Measured GPS parameters (Rx 3) as a function of 1-MHz PRF, 50% ARD, gated (20% duty cycle) UWB interference.

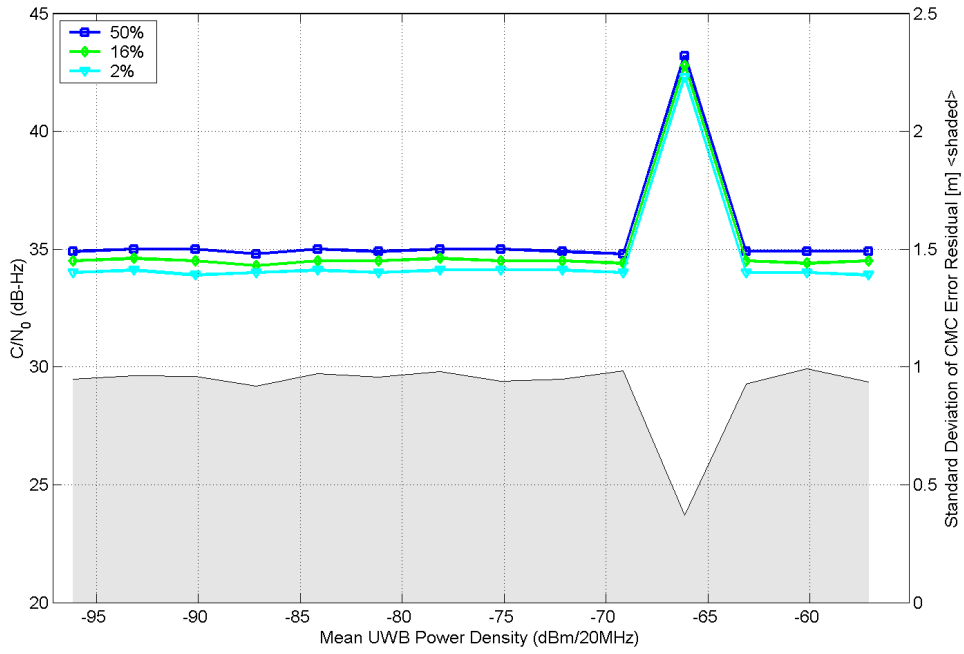

Figure B.1.24. Measured GPS parameters (Rx 3) as a function of 0.1-MHz PRF, 50% ARD, non-gated UWB interference.

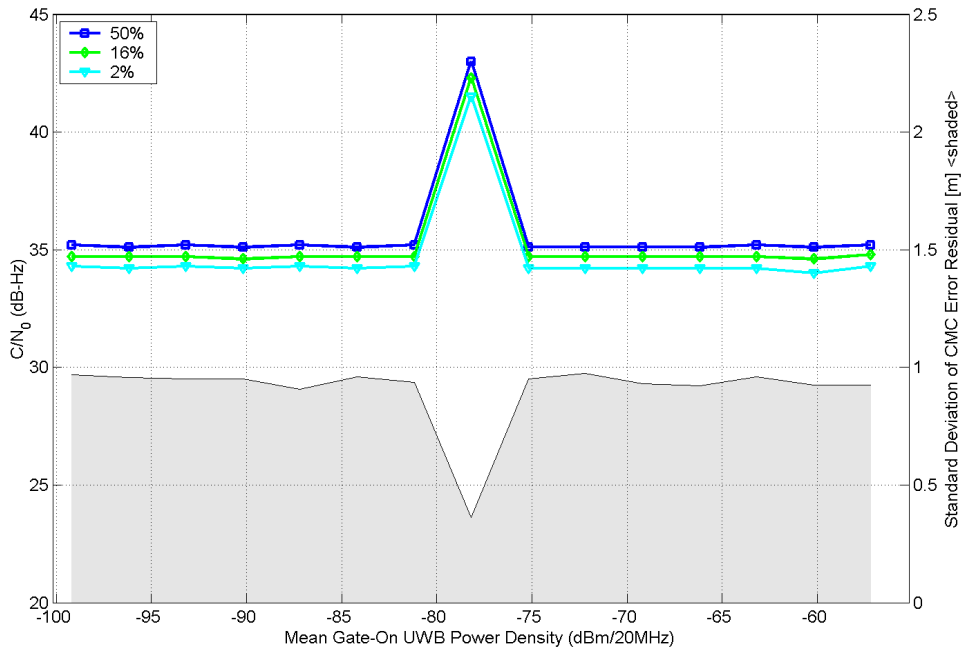

Figure B.1.25. Measured GPS parameters (Rx 3) as a function of 0.1-MHz PRF, 50% ARD, gated (20% duty cycle) UWB interference.

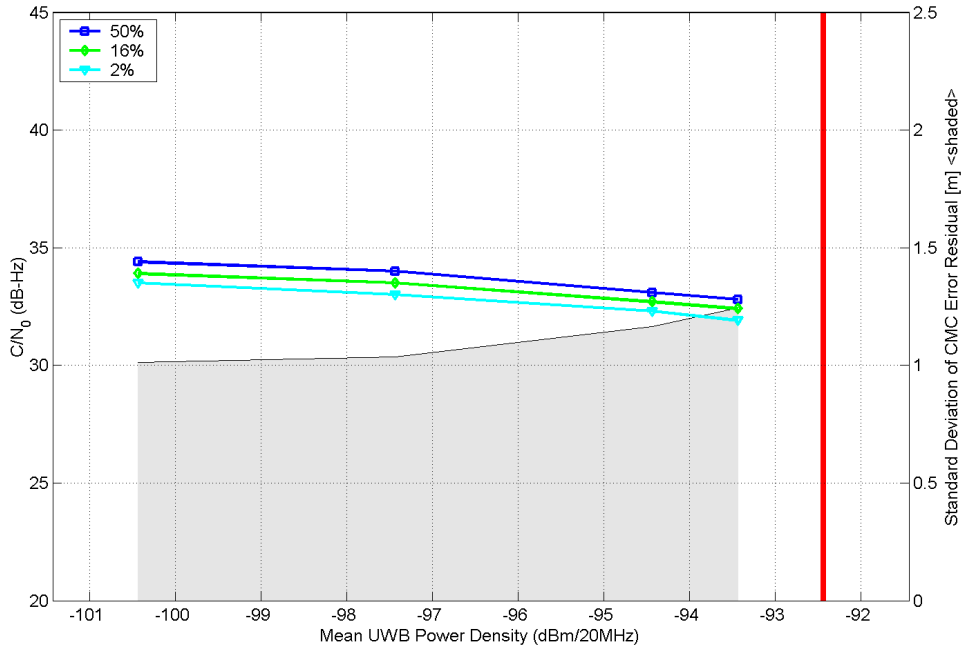

Figure B.1.26. Measured GPS parameters (Rx 3) as a function of 20-MHz PRF, 2% RRD, non-gated UWB interference.

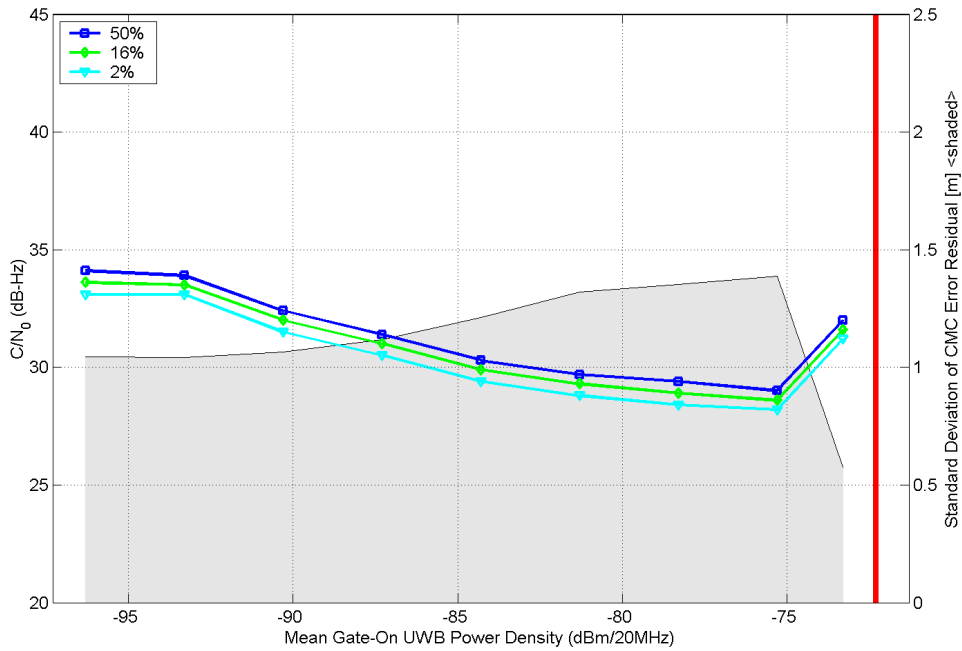

Figure B.1.27. Measured GPS parameters (Rx 3) as a function of 20-MHz PRF, 2% RRD, gated (20% duty cycle) UWB interference.

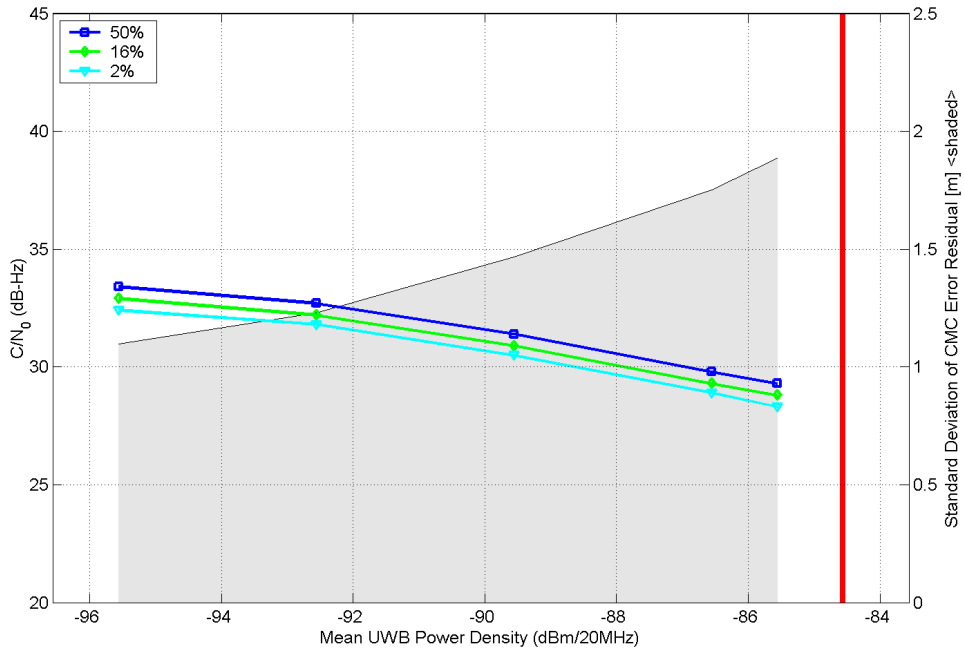

Figure B.1.28. Measured GPS parameters (Rx 3) as a function of 5-MHz PRF, 2% RRD, non-gated UWB interference.

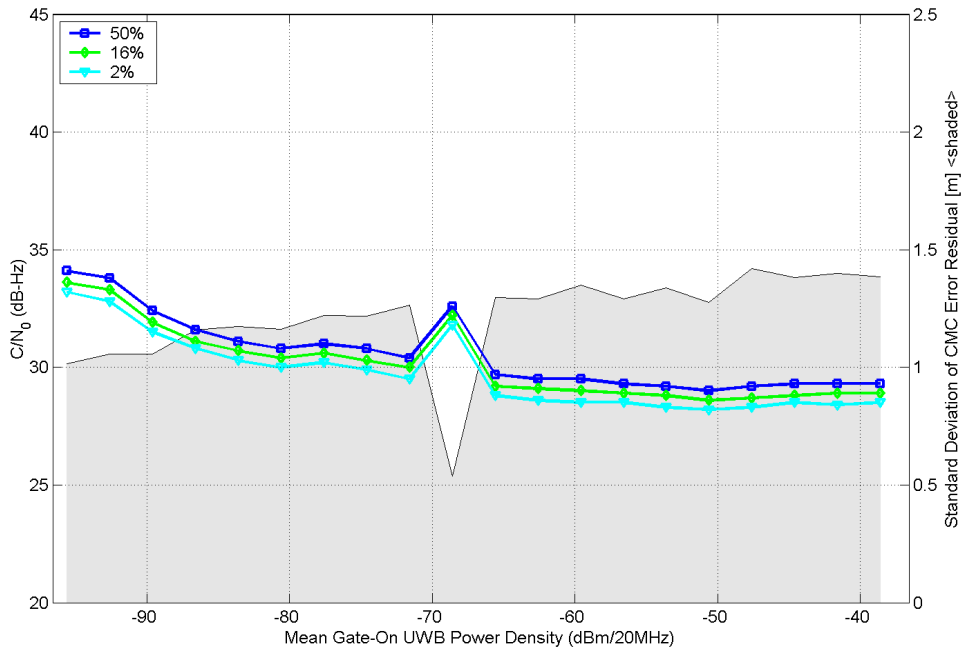

Figure B.1.29. Measured GPS parameters (Rx 3) as a function of 5-MHz PRF, 2% RRD, gated (20% duty cycle) UWB interference.

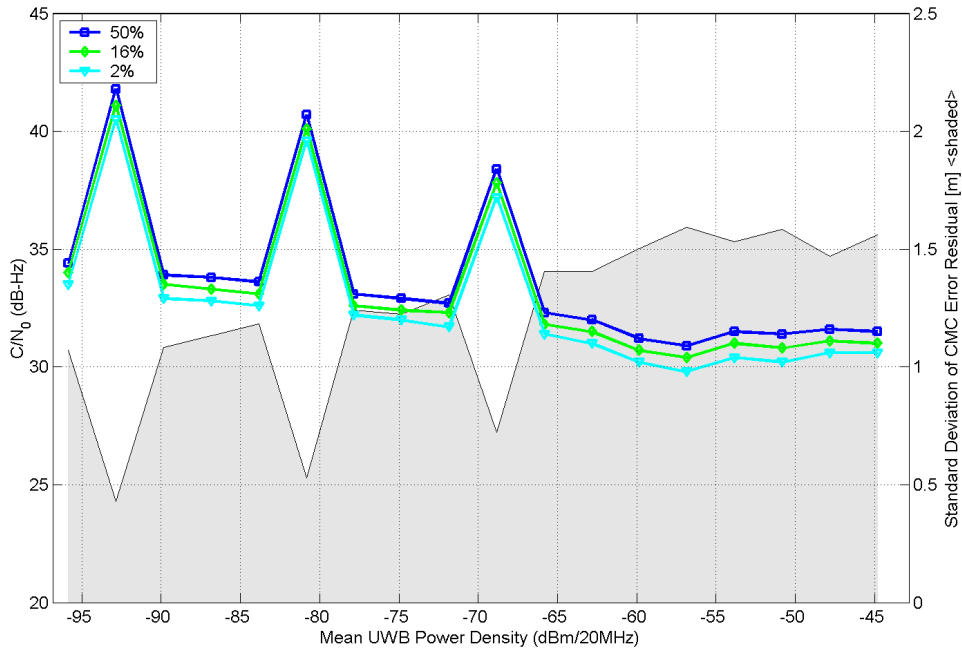

Figure B.1.30. Measured GPS parameters (Rx 3) as a function of 1-MHz PRF, 2% RRD, non-gated UWB interference.

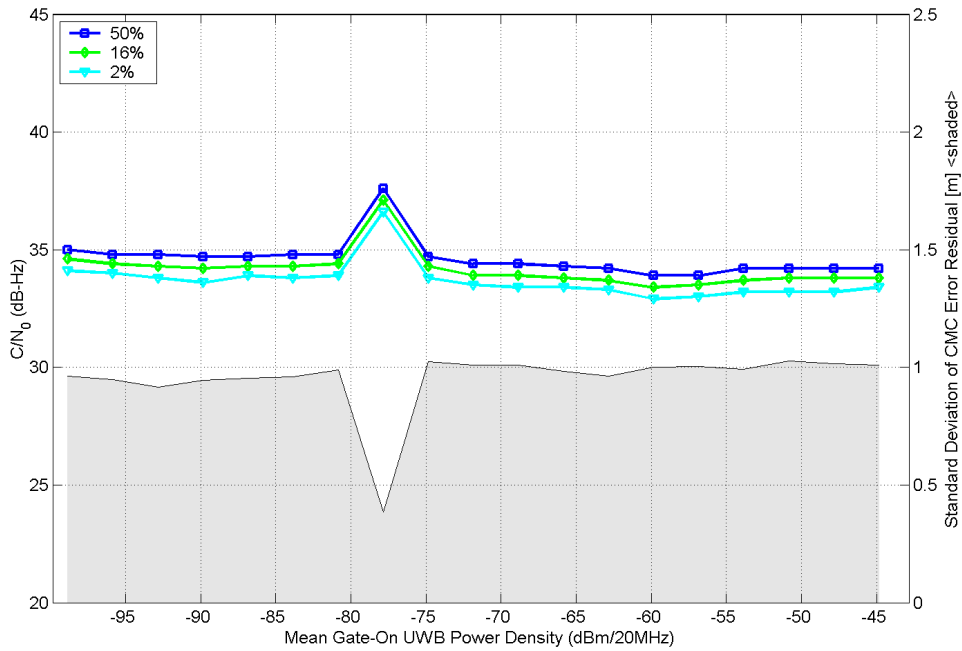

Figure B.1.31. Measured GPS parameters (Rx 3) as a function of 1-MHz PRF, 2% RRD, gated (20% duty cycle) UWB interference.

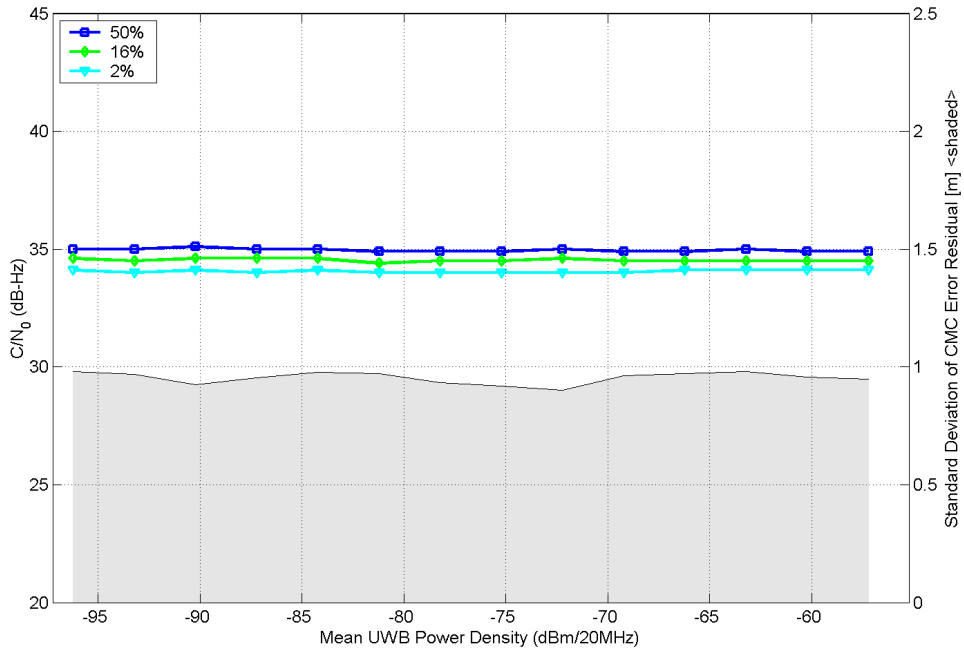

Figure B.1.32. Measured GPS parameters (Rx 3) as a function of 0.1-MHz PRF, 2% RRD, non-gated UWB interference.

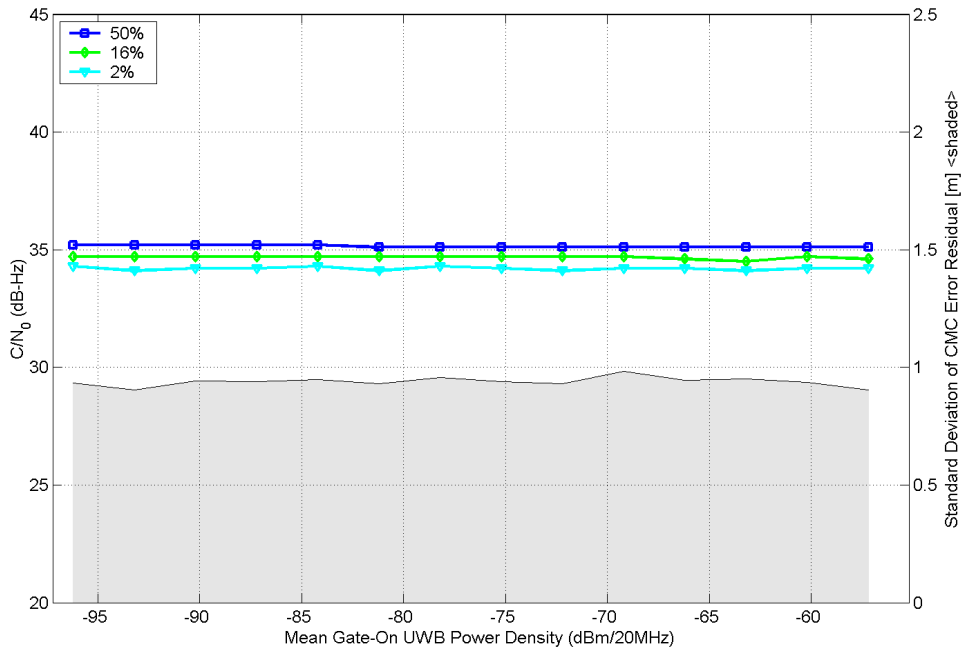

Figure B.1.33. Measured GPS parameters (Rx 3) as a function of 0.1-MHz PRF, 2% RRD, gated (20% duty cycle) UWB interference.

B.2. TSO-C129a Aviation Receiver (Rx 4) Results

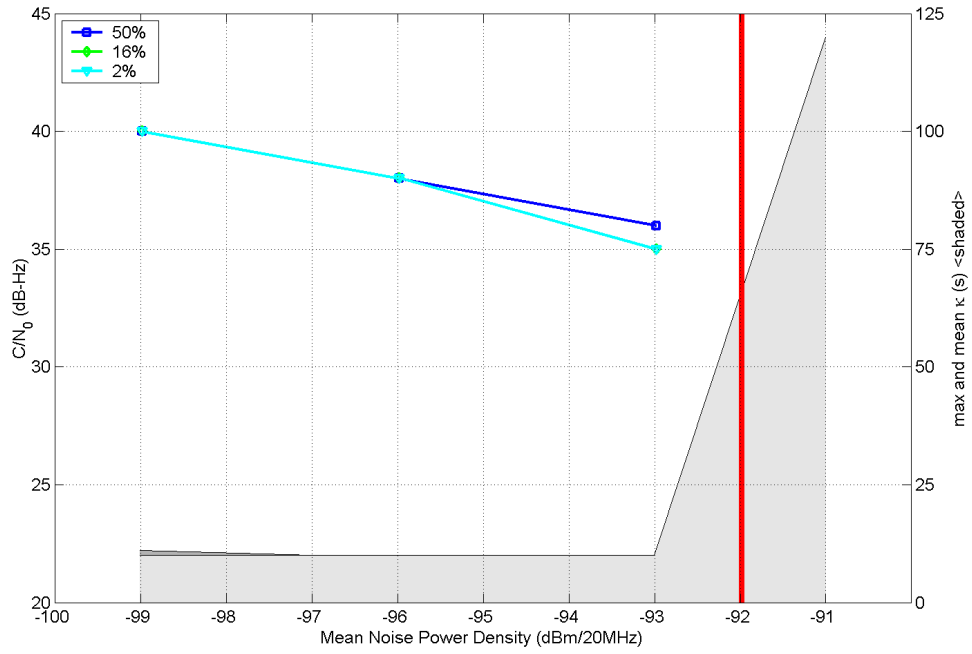

Figure B.2.1. Measured GPS parameters (Rx 4) as a function of Gaussian-noise interference.

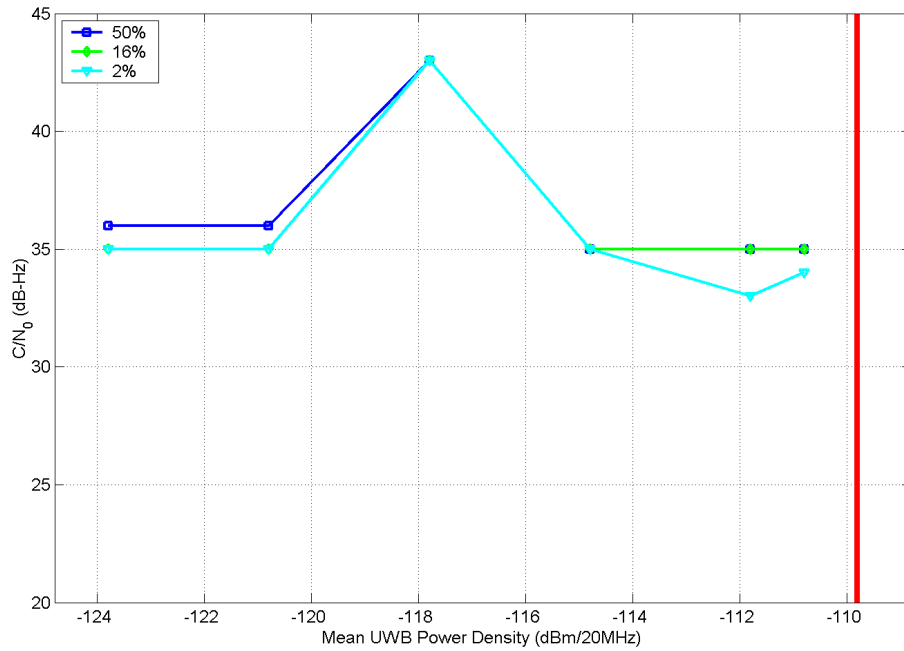

Figure B.2.2. Measured GPS parameters (Rx 4) as a function of 20-MHz PRF, UPS, non-gated UWB interference.

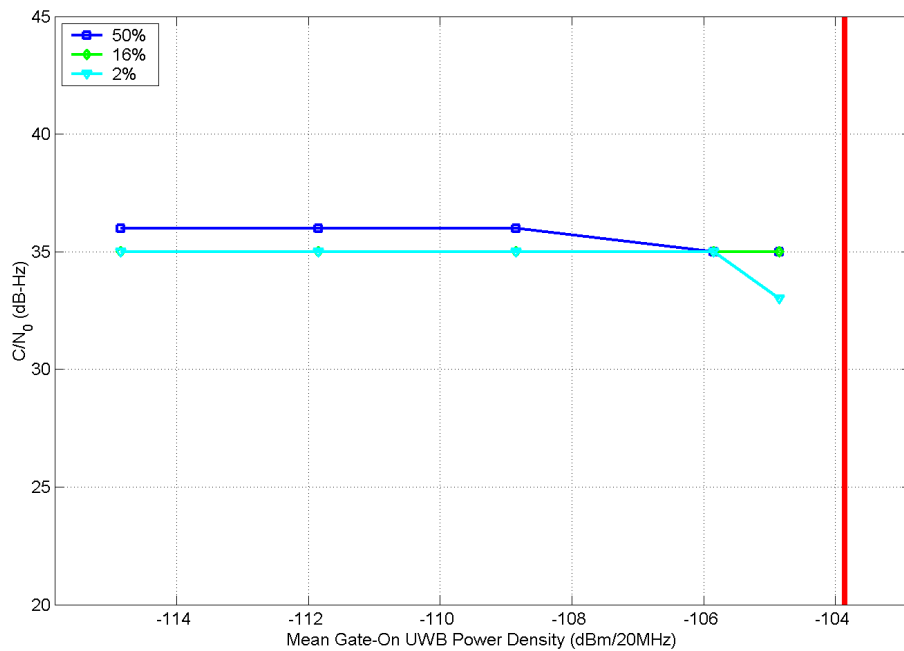

Figure B.2.3. Measured GPS parameters (Rx 4) as a function of 20-MHz PRF, UPS, gated (20% duty cycle) UWB interference.

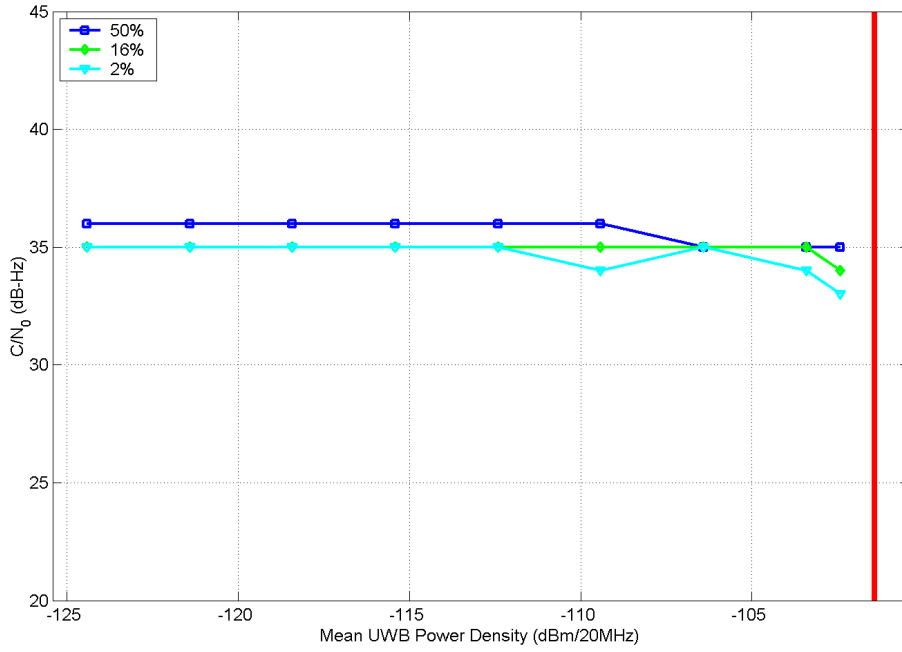

Figure B.2.4. Measured GPS parameters (Rx 4) as a function of 5-MHz PRF, UPS, non-gated UWB interference.

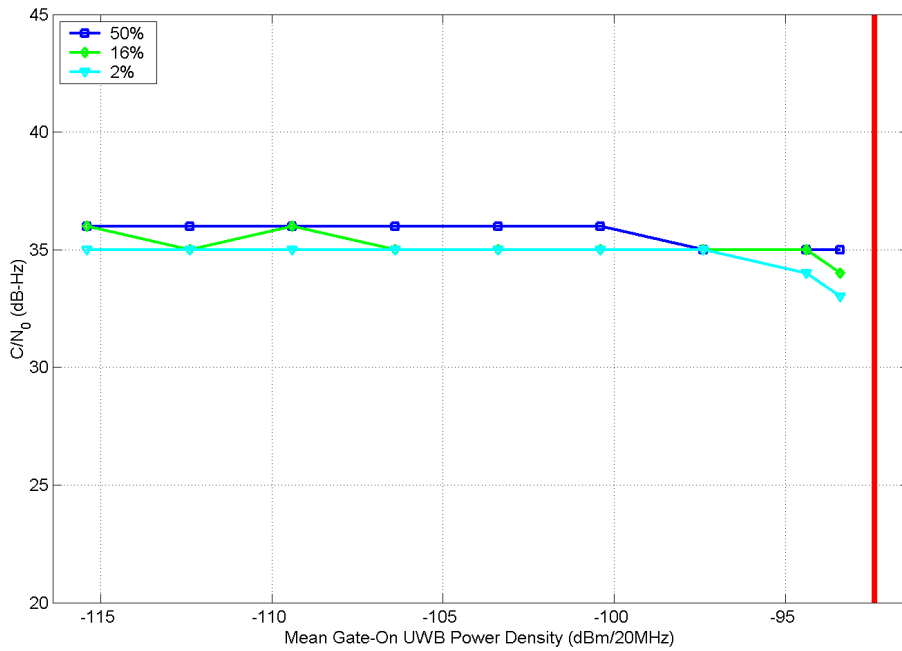

Figure B.2.5. Measured GPS parameters (Rx 4) as a function of 5-MHz PRF, UPS, gated (20% duty cycle) UWB interference.

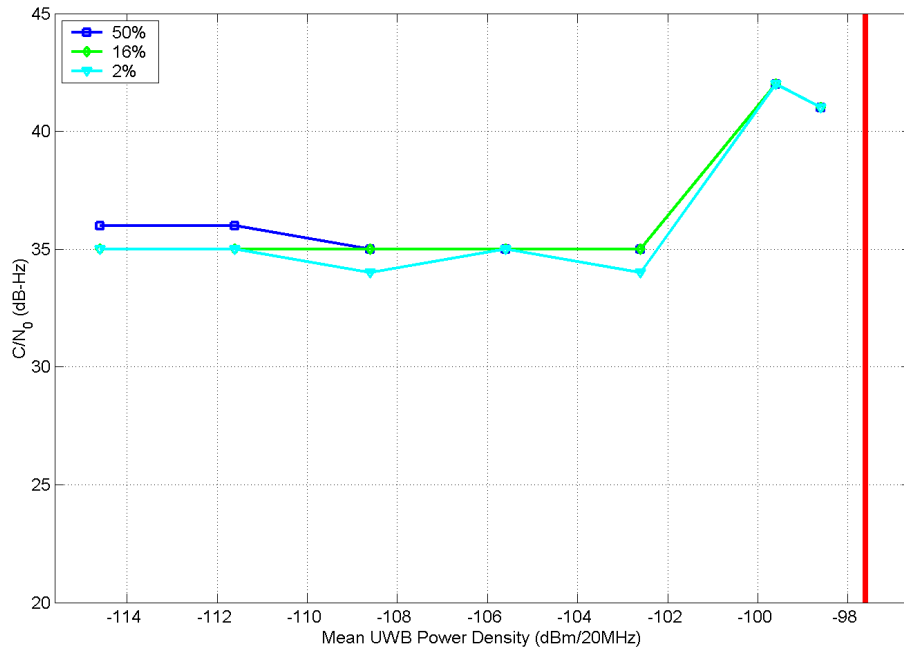

Figure B.2.6. Measured GPS parameters (Rx 4) as a function of 1-MHz PRF, UPS, non-gated UWB interference.

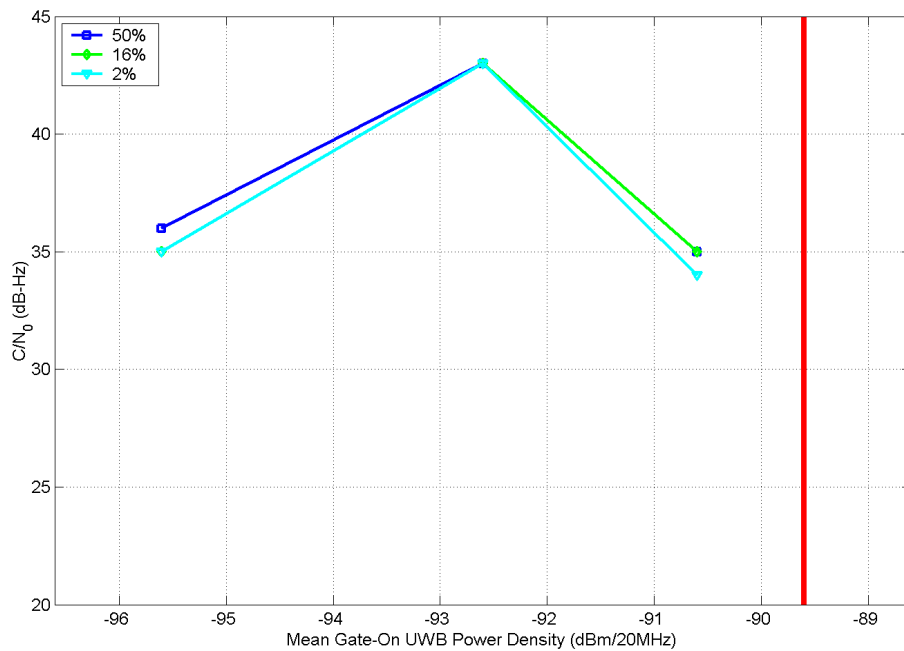

Figure B.2.7. Measured GPS parameters (Rx 4) as a function of 1-MHz PRF, UPS, gated (20% duty cycle) UWB interference.

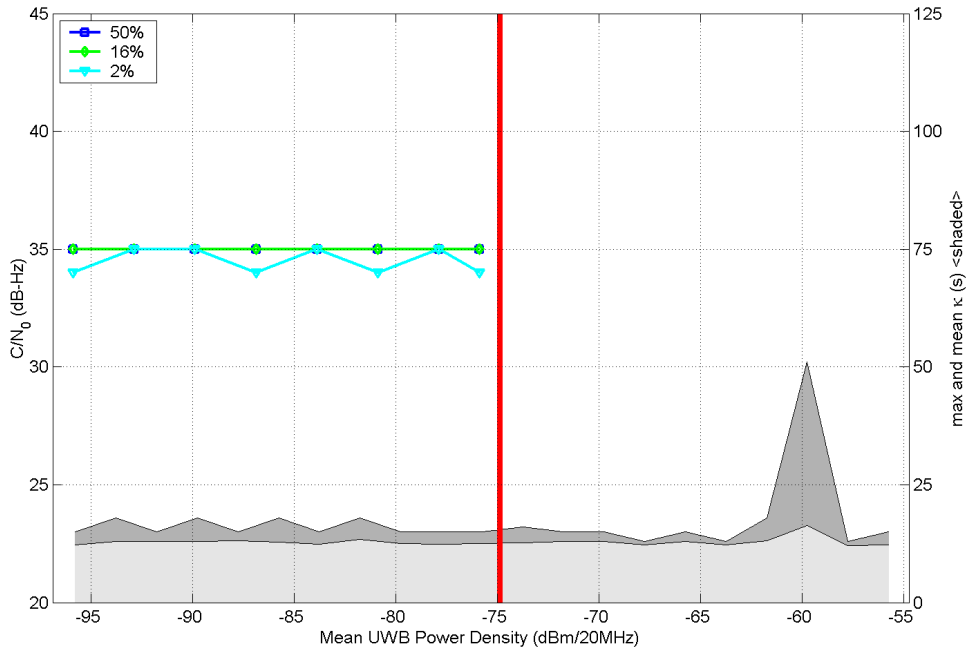

Figure B.2.8. Measured GPS parameters (Rx 4) as a function of 0.1-MHz PRF, UPS, non-gated UWB interference.

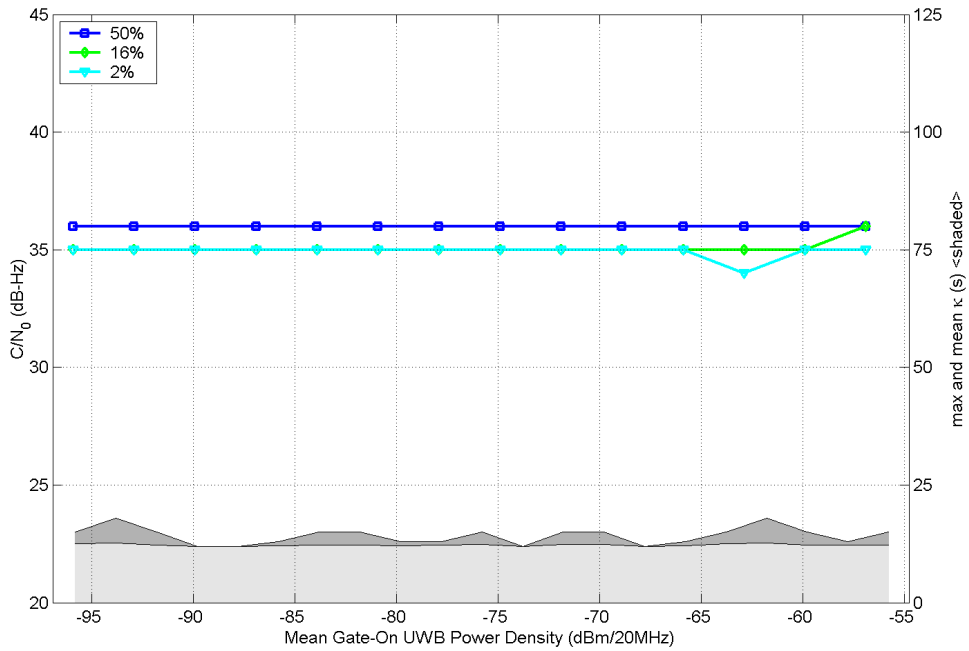

Figure B.2.9. Measured GPS parameters (Rx 4) as a function of 0.1-MHz PRF, UPS, gated (20% duty cycle) UWB interference.

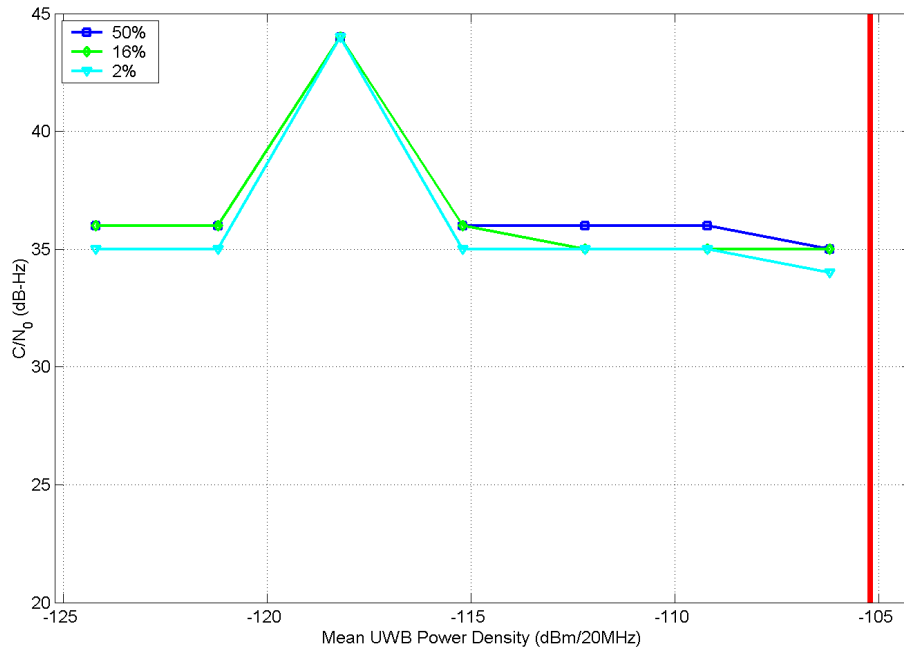

Figure B.2.10. Measured GPS parameters (Rx 4) as a function of 20-MHz PRF, OOK, non-gated UWB interference.

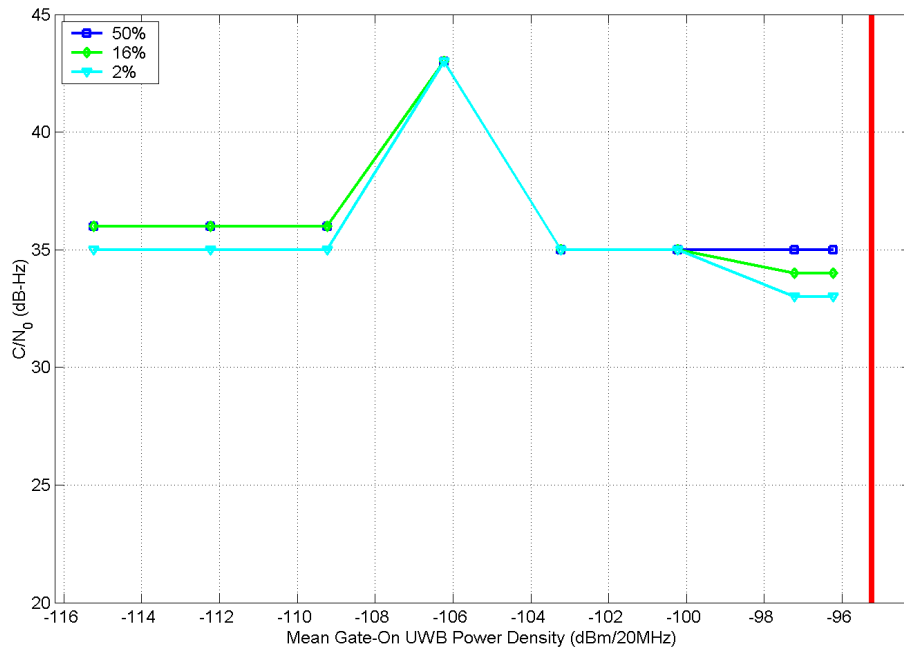

Figure B.2.11. Measured GPS parameters (Rx 4) as a function of 20-MHz PRF, OOK, gated (20% duty cycle) UWB interference.

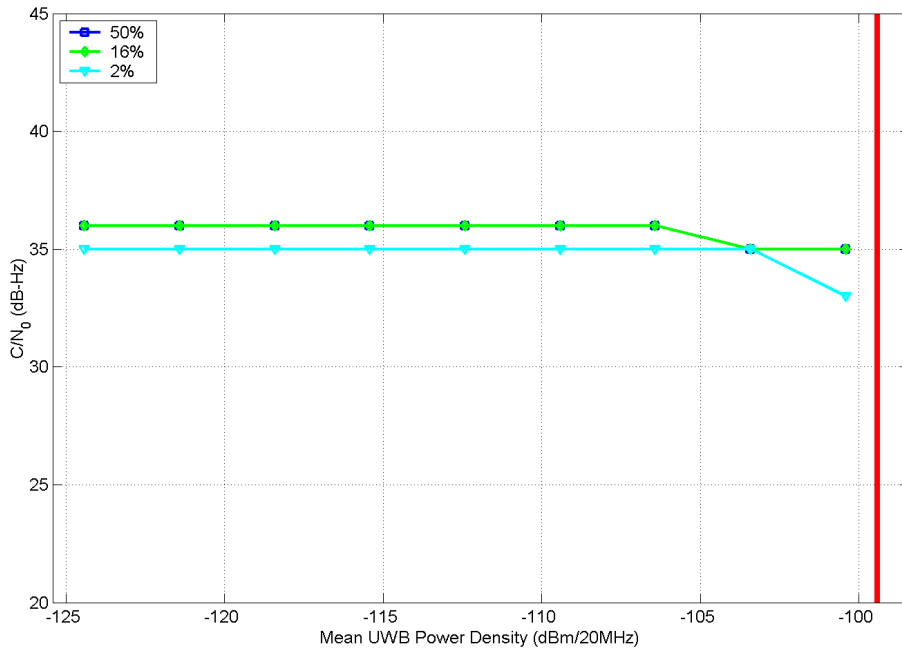

Figure B.2.12. Measured GPS parameters (Rx 4) as a function of 5-MHz PRF, OOK, non-gated UWB interference.

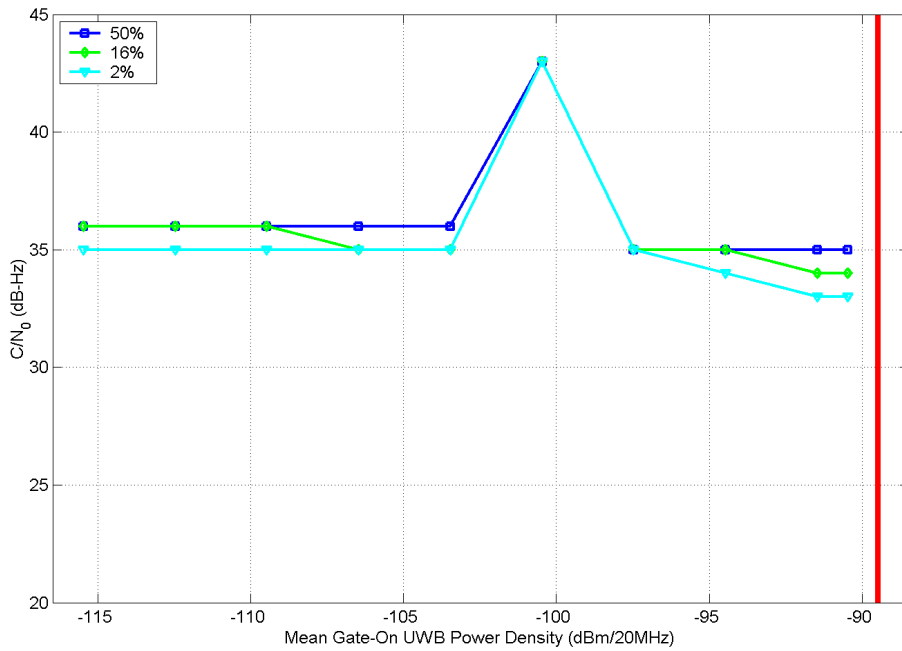

Figure B.2.13. Measured GPS parameters (Rx 4) as a function of 5-MHz PRF, OOK, gated (20% duty cycle) UWB interference.

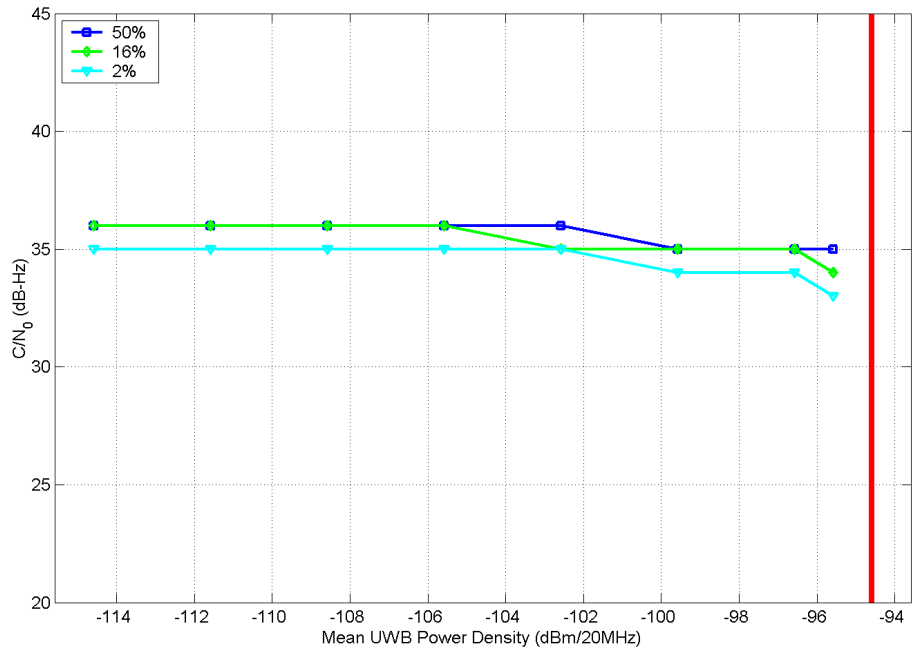

Figure B.2.14. Measured GPS parameters (Rx 4) as a function of 1-MHz PRF, OOK, non-gated UWB interference.

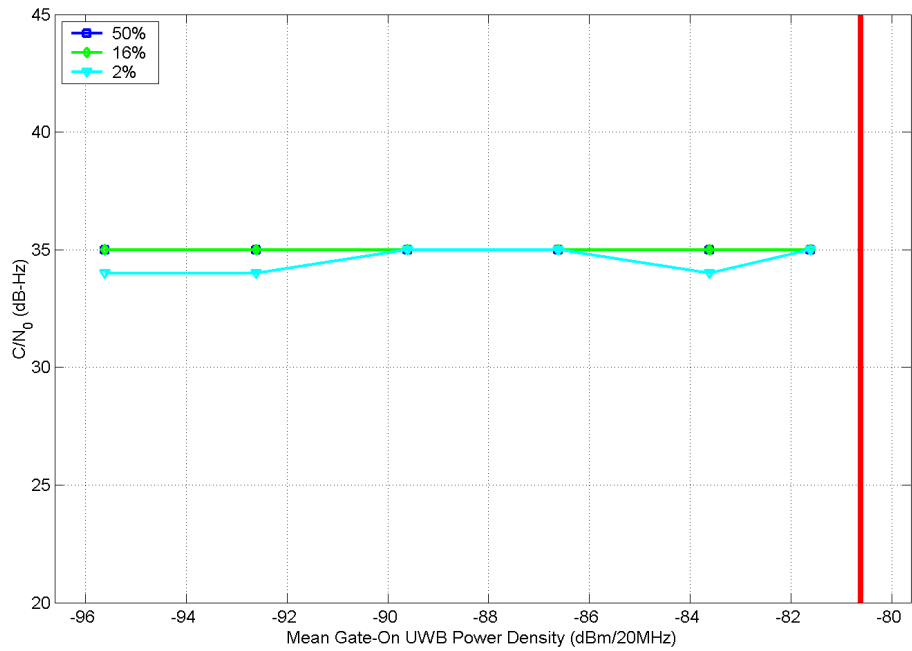

Figure B.2.15. Measured GPS parameters (Rx 4) as a function of 1-MHz PRF, OOK, gated (20% duty cycle) UWB interference.

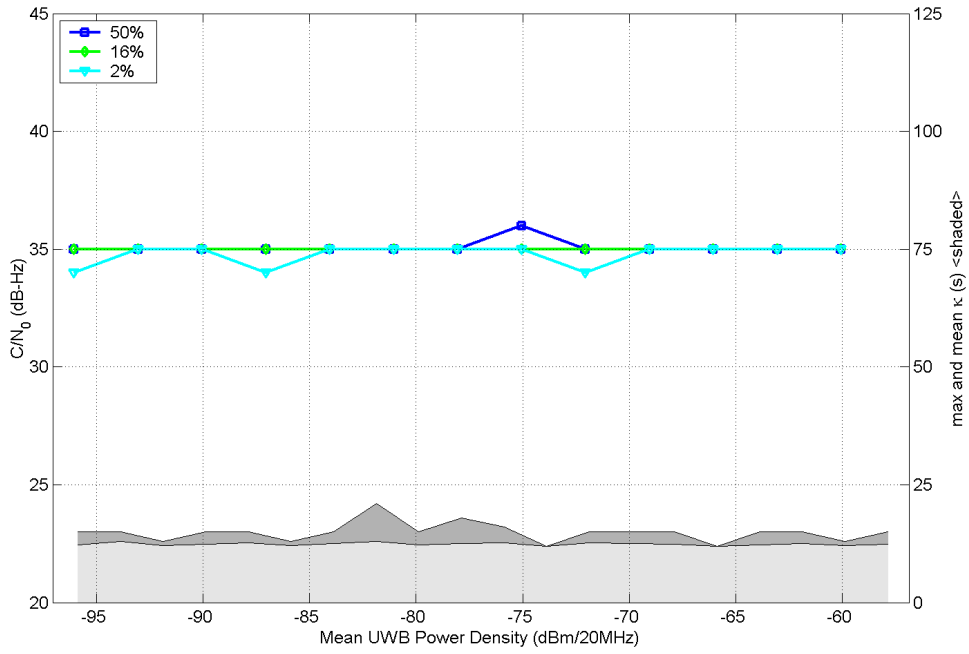

Figure B.2.16. Measured GPS parameters (Rx 4) as a function of 0.1-MHz PRF, OOK, non-gated UWB interference.

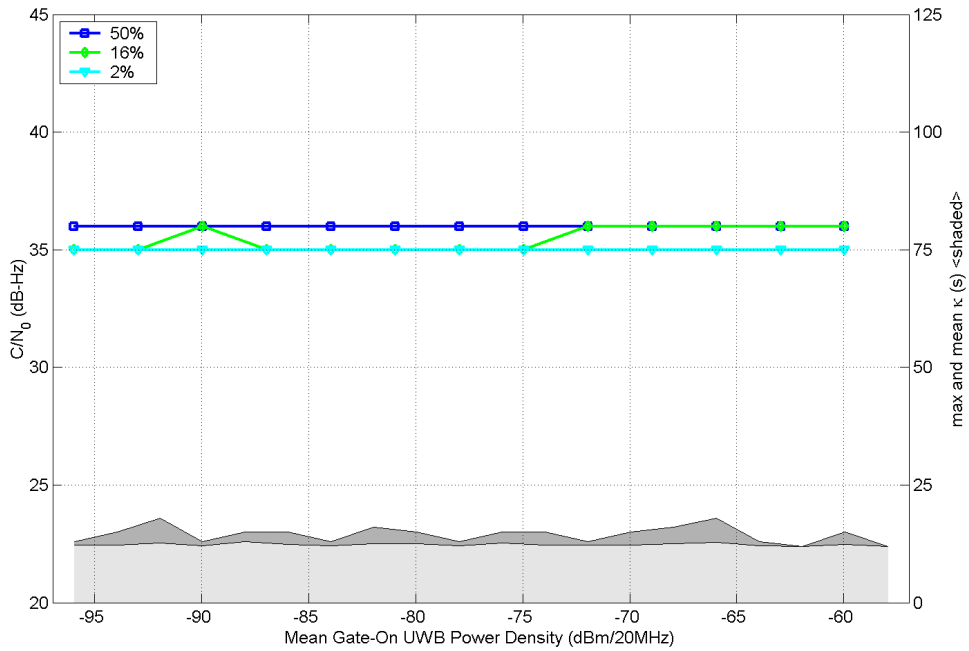

Figure B.2.17. Measured GPS parameters (Rx 4) as a function of 0.1-MHz PRF, OOK, gated (20% duty cycle) UWB interference.

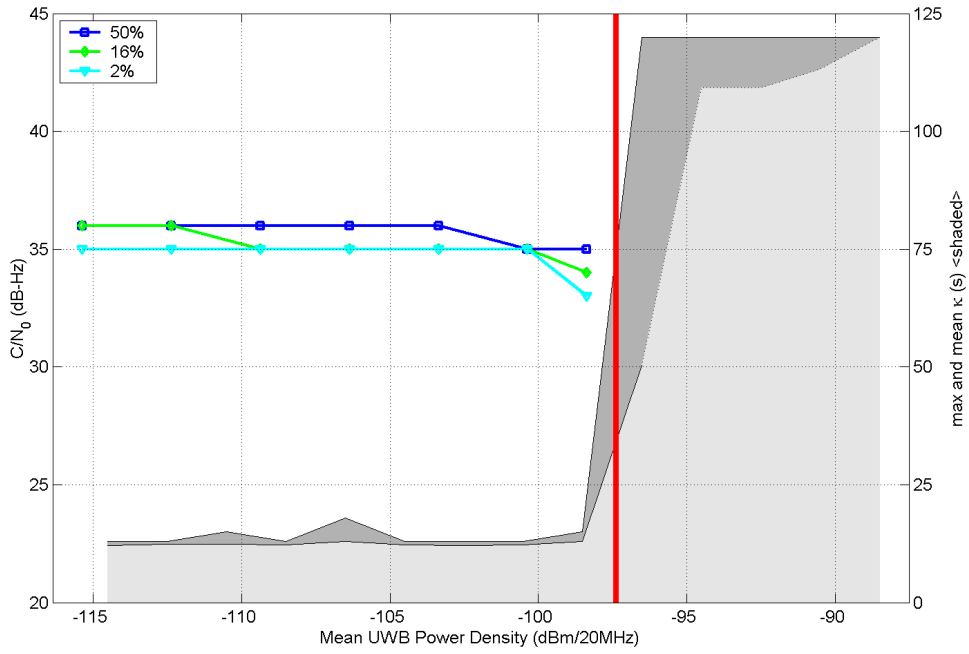

Figure B.2.18. Measured GPS parameters (Rx 4) as a function of 20-MHz PRF, 50% ARD, non-gated UWB interference.

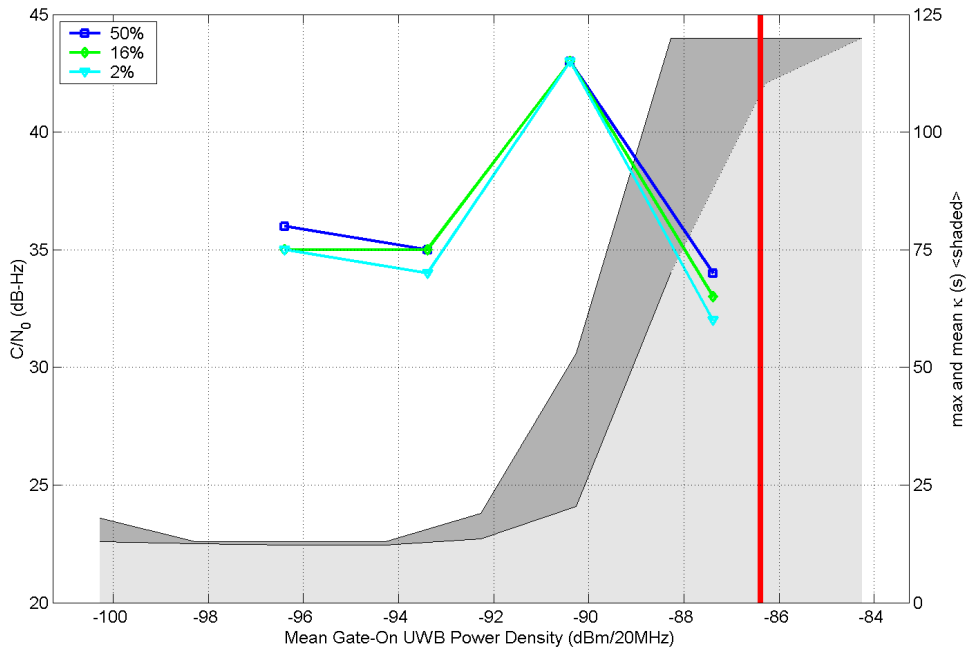

Figure B.2.19. Measured GPS parameters (Rx 4) as a function of 20-MHz PRF, 50% ARD, gated (20% duty cycle) UWB interference.

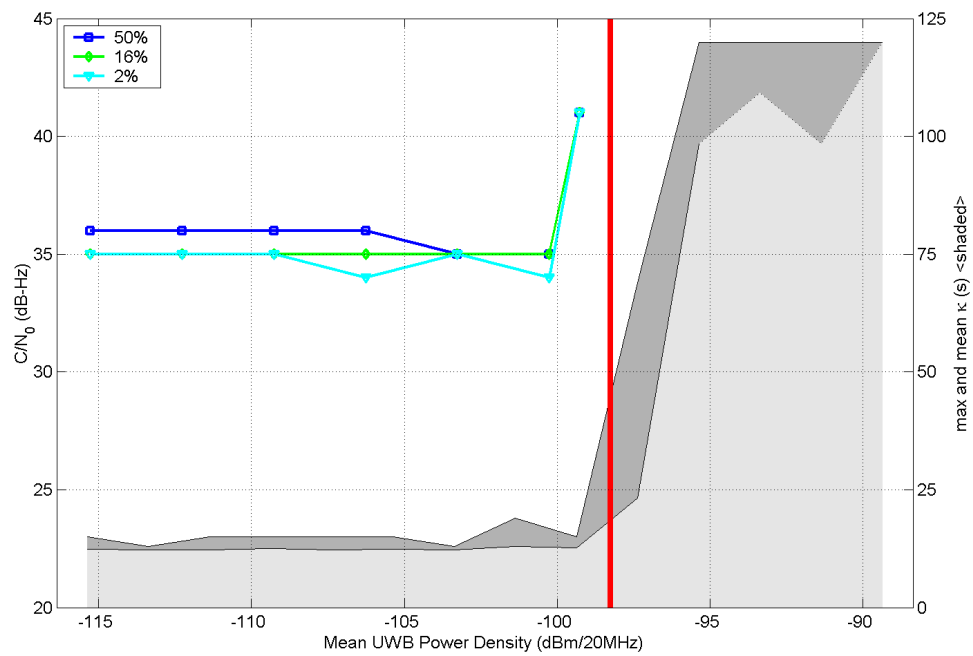

Figure B.2.20. Measured GPS parameters (Rx 4) as a function of 5-MHz PRF, 50% ARD, non-gated UWB interference.

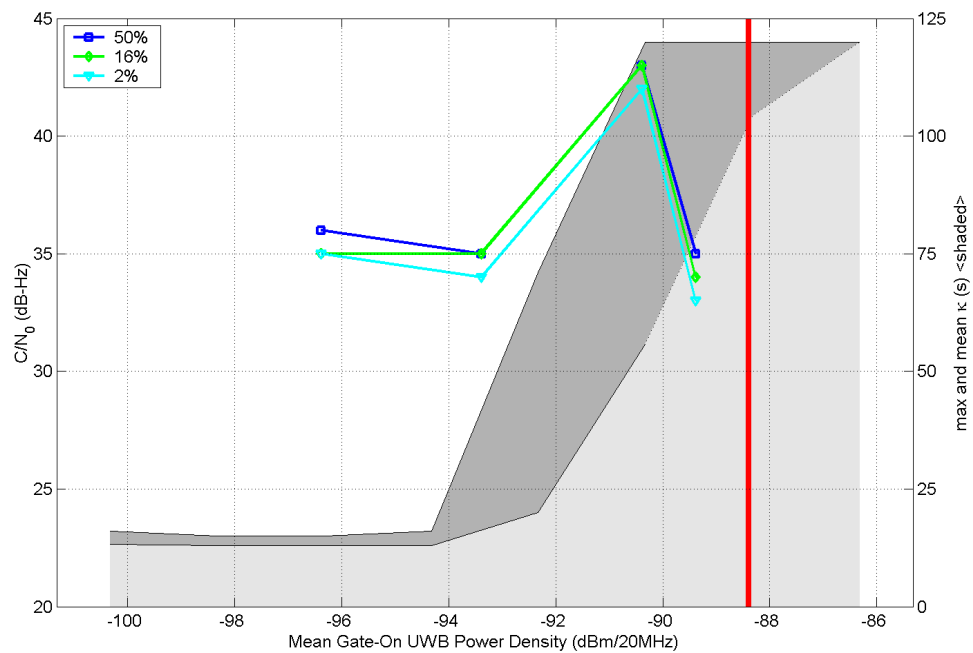

Figure B.2.21. Measured GPS parameters (Rx 4) as a function of 5-MHz PRF, 50% ARD, gated (20% duty cycle) UWB interference.

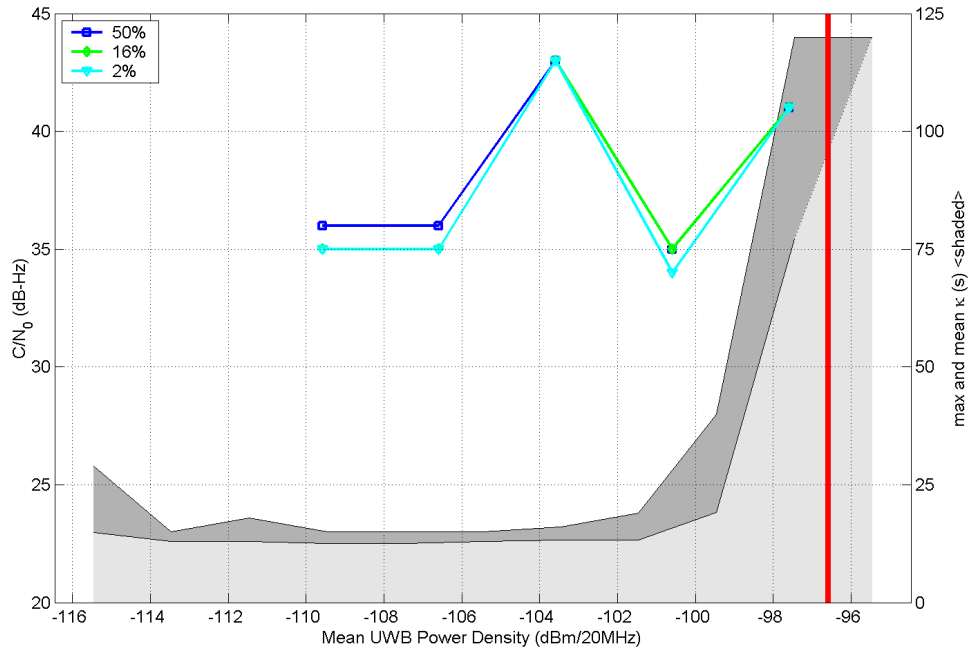

Figure B.2.22. Measured GPS parameters (Rx 4) as a function of 1-MHz PRF, 50% ARD, non-gated UWB interference.

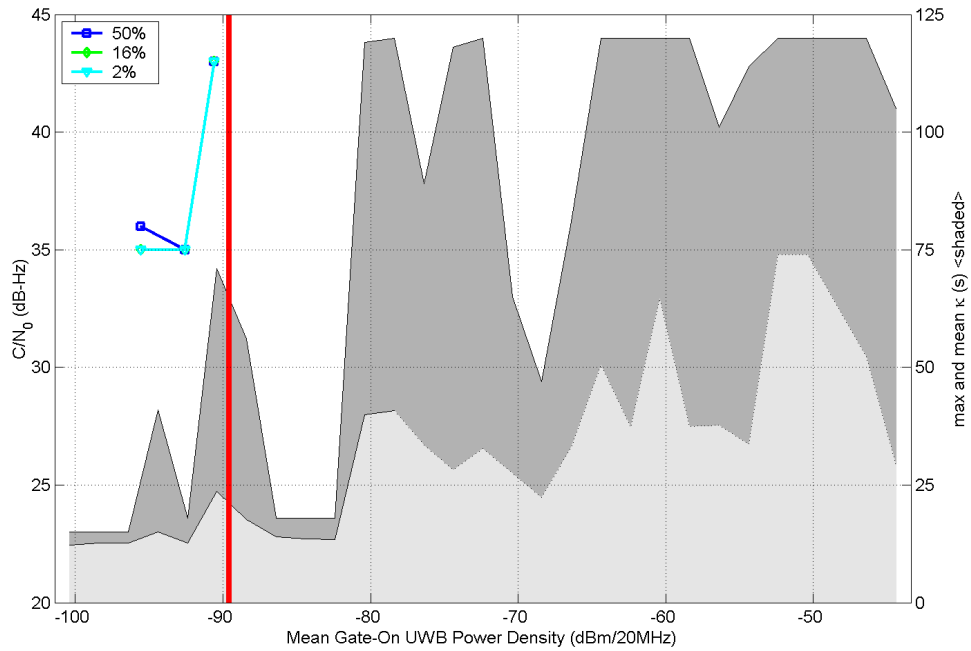

Figure B.2.23. Measured GPS parameters (Rx 4) as a function of 1-MHz PRF, 50% ARD, gated (20% duty cycle) UWB interference.

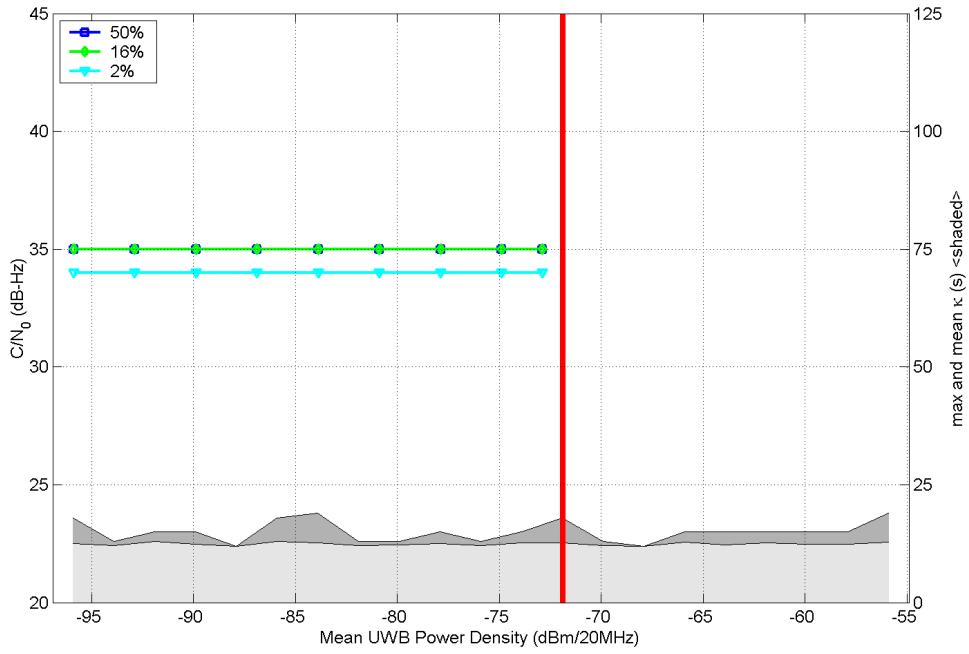

Figure B.2.24. Measured GPS parameters (Rx 4) as a function of 0.1-MHz PRF, 50% ARD, non-gated UWB interference.

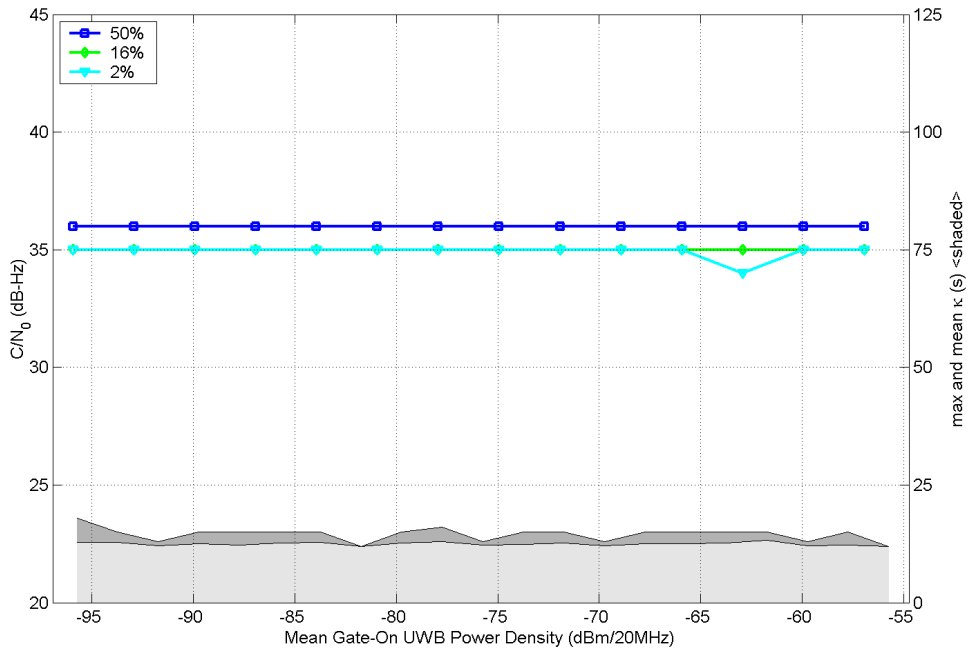

Figure B.2.25. Measured GPS parameters (Rx 4) as a function of 0.1-MHz PRF, 50% ARD, gated (20% duty cycle) UWB interference.

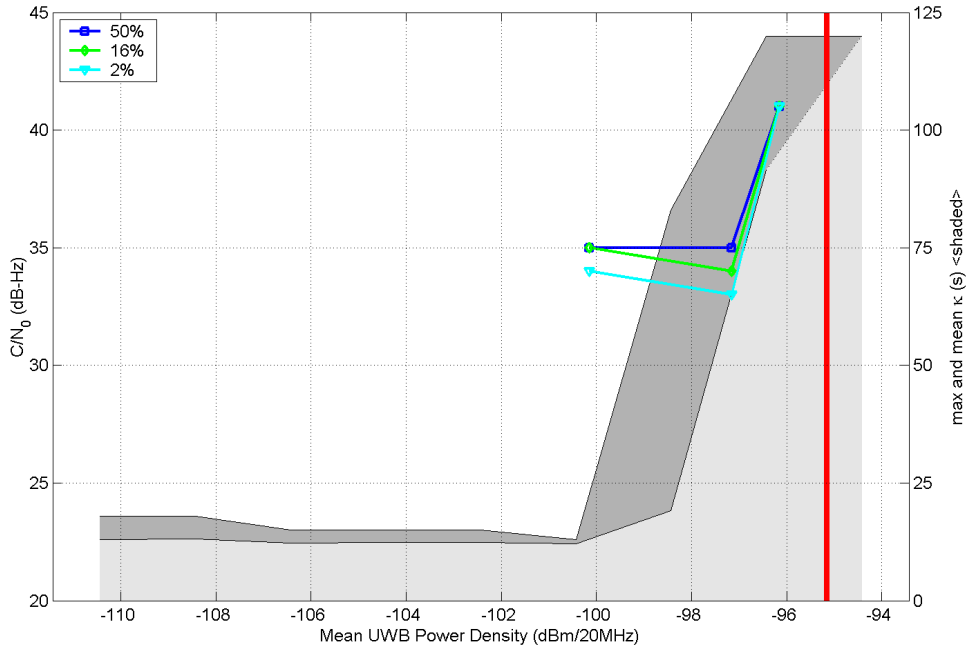

Figure B.2.26. Measured GPS parameters (Rx 4) as a function of 20-MHz PRF, 2% RRD, non-gated UWB interference.

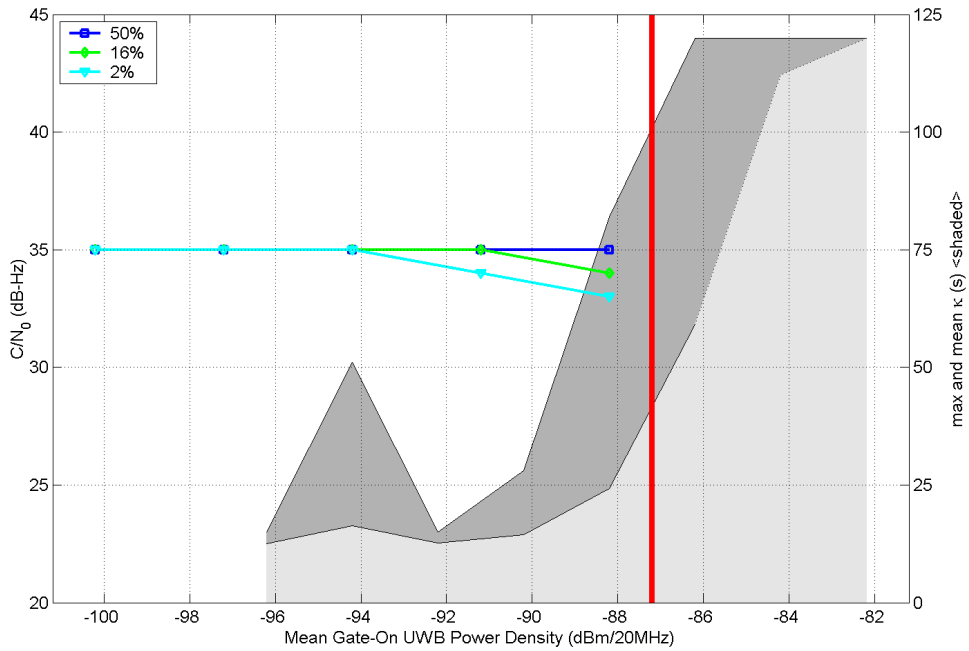

Figure B.2.27. Measured GPS parameters (Rx 4) as a function of 20-MHz PRF, 2% RRD, gated (20% duty cycle) UWB interference.

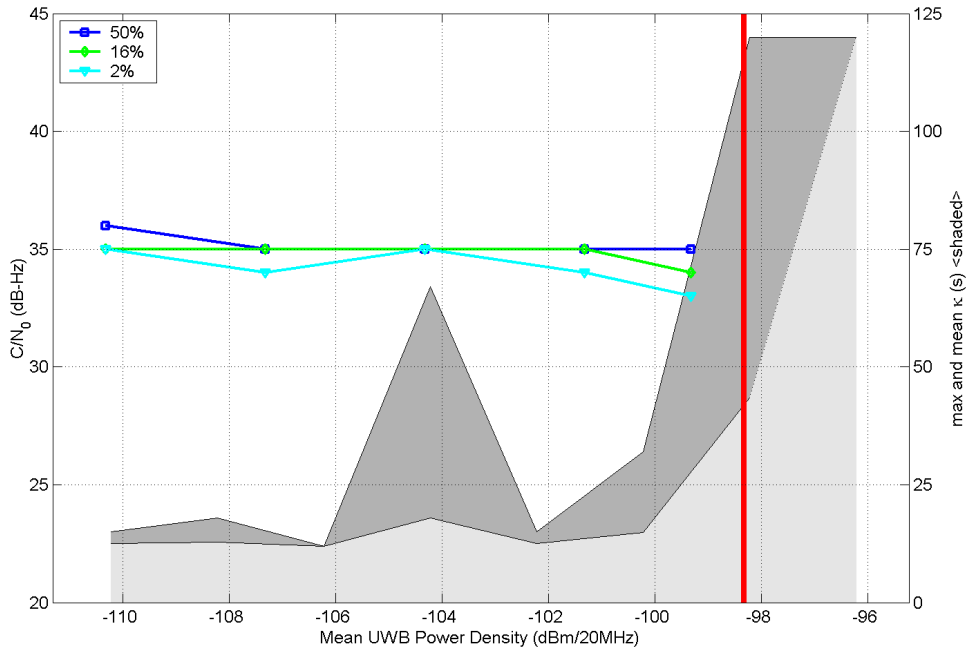

Figure B.2.28. Measured GPS parameters (Rx 4) as a function of 5-MHz PRF, 2% RRD, non-gated UWB interference.

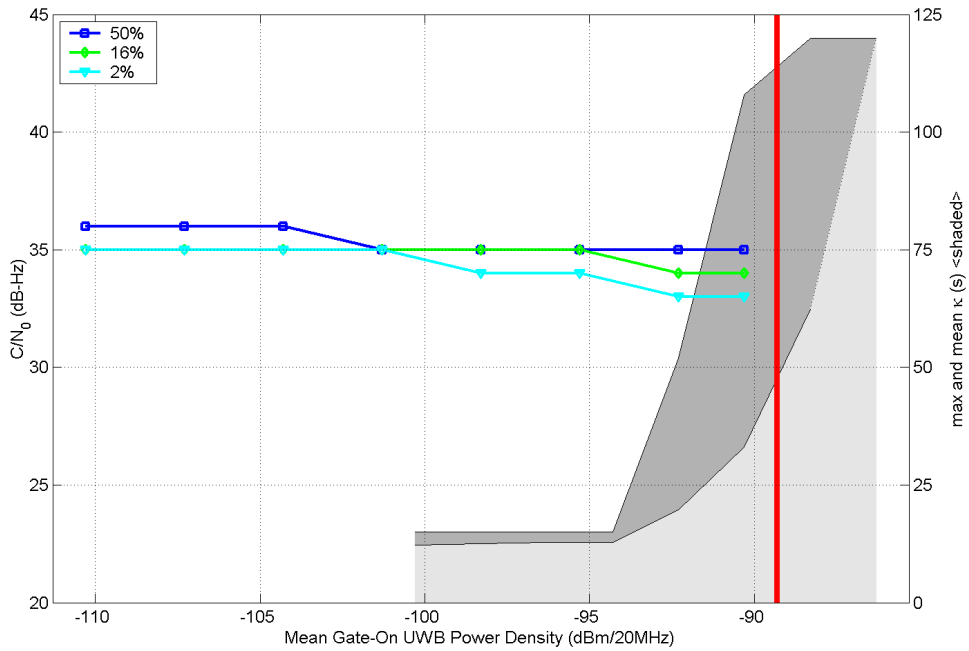

Figure B.2.29. Measured GPS parameters (Rx 4) as a function of 5-MHz PRF, 2% RRD, gated (20% duty cycle) UWB interference.

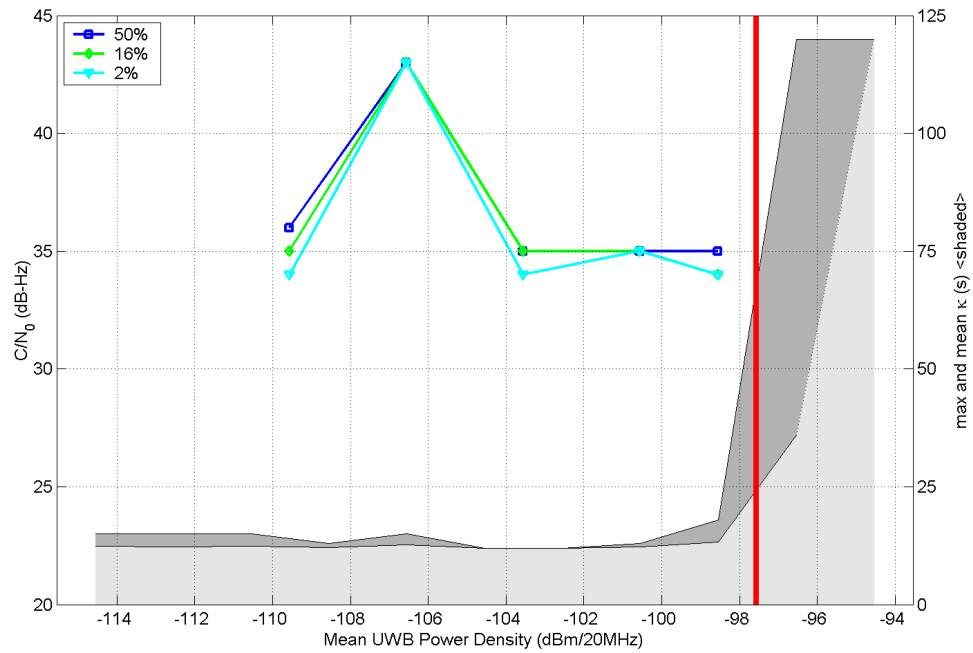

Figure B.2.30. Measured GPS parameters (Rx 4) as a function of 1-MHz PRF, 2% RRD, non-gated UWB interference.

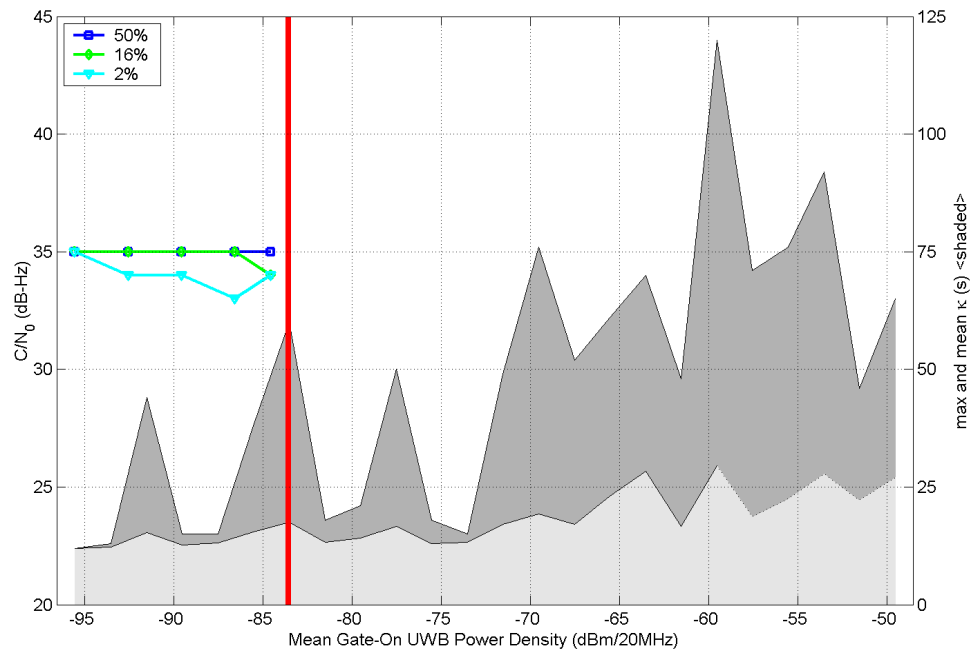

Figure B.2.31. Measured GPS parameters (Rx 4) as a function of 1-MHz PRF, 2% RRD, gated (20% duty cycle) UWB interference.

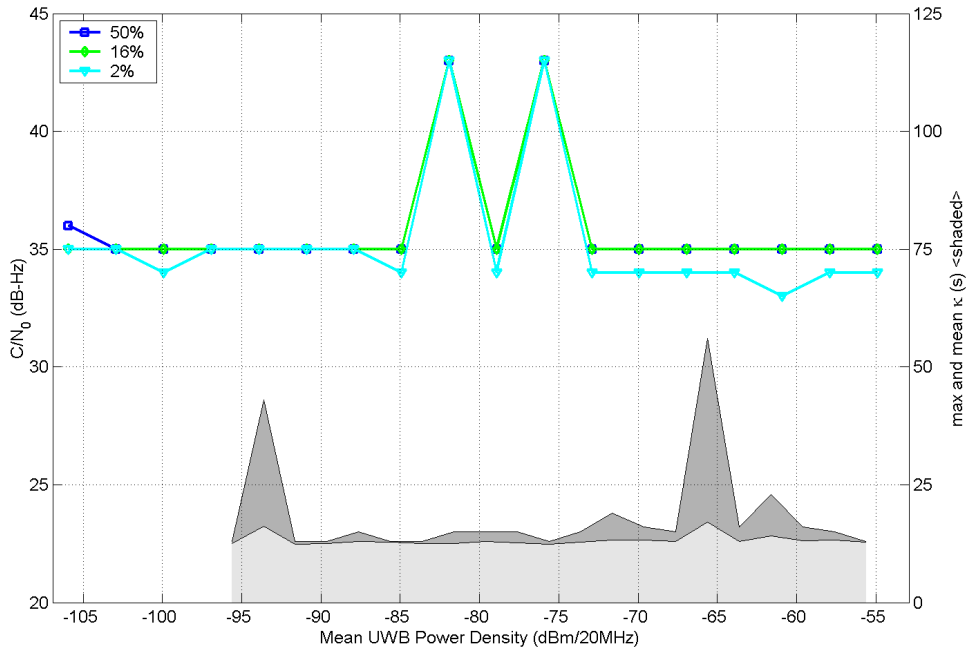

Figure B.2.32. Measured GPS parameters (Rx 4) as a function of 0.1-MHz PRF, 2% RRD, non-gated UWB interference.

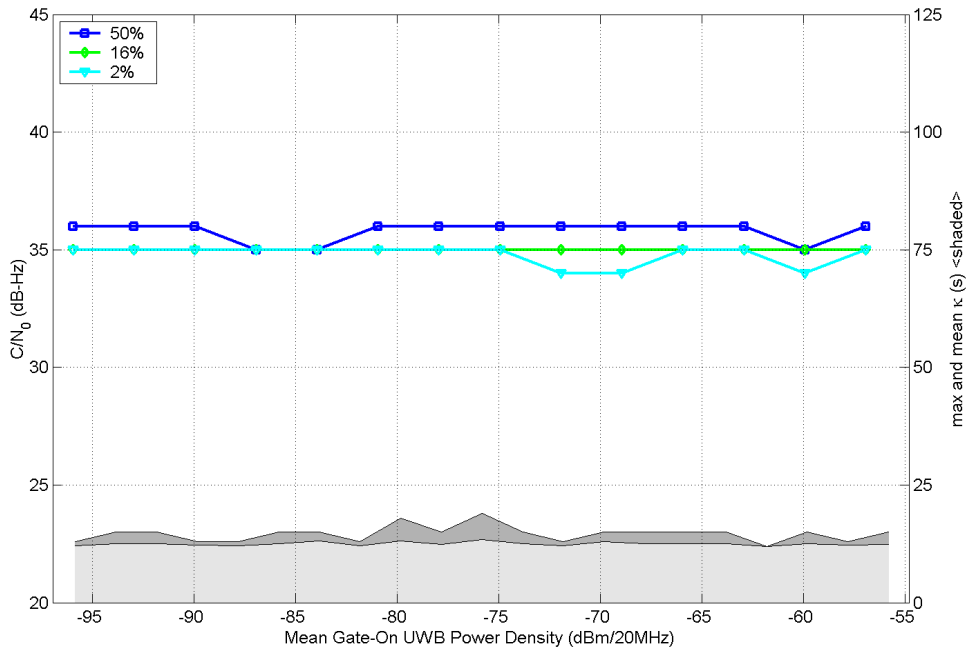

Figure B.2.33. Measured GPS parameters (Rx 4) as a function of 0.1-MHz PRF, 2% RRD, gated (20% duty cycle) UWB interference.