

Broadband Spectrum Survey at San Diego, California

**Frank H. Sanders
Bradley J. Ramsey
Vincent S. Lawrence**



**U.S. DEPARTMENT OF COMMERCE
Mickey Kantor, Secretary**

Larry Irving, Assistant Secretary
for Communications and Information

December 1996

PREFACE

A spectrum survey often depends upon significant efforts by personnel not directly involved in the measurements. We wish to thank the following people who made the spectrum survey at San Diego, California a success: Commander H. Hugo of the Naval Command, Control and Ocean Surveillance Center (**NCCOSC**), who granted us permission to use the Battery **Ashburn** area on Pt. Loma for the survey; T. **DiMattio** of the **Cabrillo** National Monument, who granted us access to Monument property; F. Kirtman of the **NCCOSC** spectrum management office, who provided us with information on individual transmitters on the Point; L. **Kilgore** of the Naval Research and Development (**NRaD**) security division, who made physical security arrangements at the site; and **H. Grigsby** of the San Diego Federal Communications Commission office for providing valuable background information on spectrum activities in the San Diego area.

Certain commercial equipment and software are identified in this report to adequately describe the measurements. In no case does such identification imply recommendation or endorsement by the National Telecommunications and Information Administration, nor does it imply that the equipment or software identified are necessarily the best available for the application.

This report, along with other ITS reports, is available on the World Wide Web through the ITS home page. The home page address is: <http://ntia/home.html>. The ITS online document page address is: <http://ntia/pub/pubs.html>.

CONTENTS

	Page
PREFACE	iii
FIGURES	vi
ABSTRACT	1
1. INTRODUCTION	1
1.1 Background	1
1.2 Authority	2
1.3 Purpose	2
1.4 Extrapolation of Spectrum Occupancy Data	2
2. OVERVIEW OF BROADBAND SPECTRUM SURVEYS	3
2.1 Introduction	3
2.2 Survey Site Selection	3
2.3 Spectrum Survey Measurements	4
3. SAN DIEGO SPECTRUM SURVEY	13
3.1 Introduction	13
3.2 Measurement Site Description.	13
3.3 Data Considerations	17
3.4 Measured Data	18
3.5 Observations on Measured Data and Spectrum Use	59
4. REFERENCES	68
A. APPENDIX A: RADIO SPECTRUM MEASUREMENT SYSTEM (RSMS)	69
B. APPENDIX B: DATA ACQUISITION SOFTWARE	79
C. APPENDIX C: INTERPRETATION OF SPECTRUM SURVEY DATA	85
D. APPENDIX D: CALIBRATION OF THE MEASUREMENT SYSTEM	99

FIGURES

		Page
Figure 1.	Area map of San Diego, California showing the location of the RSMS measurement site	14
Figure 2.	Area map of San Diego, California showing line-of-sight areas from the RSMS measurement site	15
Figure 3.	ITS Radio Spectrum Measurement System at Point Loma, San Diego, California	16
Figure 4.	Spectrum survey graph summarizing swept/m3 measurements in the 108-138 MHz frequency range.	19
Figure 5.	Spectrum survey graph summarizing swept/m3 measurements in the 138-162 MHz frequency range.	20
Figure 6.	Spectrum survey graph summarizing swept/m3 measurements in the 162-174 MHz frequency range.	21
Figure 7.	Spectrum survey graph summarizing swept/m3 measurements in the 174-216 MHz frequency range.	22
Figure 8.	Spectrum survey graph summarizing swept/m3 measurements in the 216-225 MHz frequency range	23
Figure 9.	Spectrum survey graph summarizing swept/m3 measurements in the 225-400 MHz frequency range	24
Figure 10.	Spectrum survey graph summarizing swept/m3 measurements in the 400-406 MHz frequency range	25
Figure 11.	Spectrum survey graph summarizing swept/m3 measurements in the 406-420 MHz frequency range	26
Figure 12.	Spectrum survey graph summarizing stepped measurements in the 420-450 MHz frequency range	27
Figure 13.	Spectrum survey graph summarizing swept/m3 measurements in the 450-470 MHz frequency range	28
Figure 14.	Spectrum survey graph summarizing swept/m3 measurements in the 470-512 MHz frequency range	29

FIGURES (Continued)

	Page
Figure 15. Spectrum survey graph summarizing swept/m3 measurements in the 512-806 MHz frequency range	30
Figure 16. Spectrum survey graph summarizing swept/m3 measurements in the 806-902 MHz frequency range	31
Figure 17. Spectrum survey graph summarizing swept measurements in the 902-928 MHz frequency range	32
Figure 18. Spectrum survey graph summarizing stepped measurements in the 902-928 MHz frequency range	33
Figure 19. Spectrum survey graph summarizing swept/m3 measurements in the 928-960 MHz frequency range	34
Figure 20. Spectrum survey graph summarizing swept/m3 measurements in the 960-1215 MHz frequency range	35
Figure 21. Spectrum survey graph summarizing stepped measurements in the 1215 -1400 MHz frequency range	36
Figure 22. Spectrum survey graph summarizing swept/m3 measurements in the 1350- 1400 MHz frequency range	37
Figure 23. Spectrum survey graph summarizing swept/m3 measurements in the 1400- 1530 MHz frequency range	38
Figure 24. Spectrum survey graph summarizing swept/m3 measurements in the 1530- 1710 MHz frequency range	39
Figure 25. Spectrum survey azimuth-scan graph of measurements in the 1710-2300 MHz frequency range	40
Figure 26. Spectrum survey graph summarizing swept measurements in the 2300-2500 MHz frequency range	41
Figure 27. Spectrum survey azimuth-scan graph of measurements in the 2500-2700 MHz frequency range	42
Figure 28. Spectrum survey graph summarizing stepped measurements in the 2700-2900 MHz frequency range	43

FIGURES (Continued)

	Page
Figure 29. Spectrum survey graph summarizing stepped measurements in the 2900-3100 MHz frequency range	44
Figure 30. Spectrum survey graph summarizing stepped measurements in the 3100-3700 MHz frequency range	45
Figure 31. Spectrum survey azimuth-scan graph of measurements in the 3700-4200 MHz frequency range	46
Figure 32. Spectrum survey graph summarizing swept/m3 measurements in the 4200-4400 MHz frequency range	47
Figure 33. Spectrum survey azimuth-scan graph of measurements in the 4400-5000 MHz frequency range	48
Figure 34. Spectrum survey graph summarizing swept/m3 measurements in the 5000-5250 MHz frequency range	49
Figure 35. Spectrum survey graph summarizing stepped measurements in the 5250-5925 MHz frequency range	50
Figure 36. Spectrum survey azimuth-scan graph of measurements in the 5925 -7125 MHz frequency range	51
Figure 37. Spectrum survey azimuth-scan graph of measurements in the 7125 -8500 MHz frequency range	52
Figure 38. Spectrum survey graph summarizing stepped measurements in the 8500-10550 MHz frequency range	53
Figure 39. Spectrum survey azimuth-scan graph of measurements in the 10550-13250 MHz frequency range	54
Figure 40. Spectrum survey graph summarizing stepped measurements in the 13250-14200 MHz frequency range	55
Figure 41. Spectrum survey azimuth-scan graph of measurements in the 14200- 15700 MHz frequency range	56
Figure 42. Spectrum survey graph summarizing stepped measurements in the 15700- 17700 MHz frequency range	57

FIGURES (Continued)

	Page
Figure 43. Spectrum survey azimuth-scan graph of measurements in the 17700-19700 MHz frequency range	58
Figure A-1. Top and side view drawings of the RSMS	70
Figure A-2. Front panel of the RSMS instrument racks	71
Figure A-3. Block diagram of the RSMS receiver	72
Figure C-1. Functional diagram of the RSMS signal-processing path for cumulated data	89
Figure D-1. Example calibration graph of noise figure and correction factor curves . .	99
Figure D-2. Typical noise diode solid state noise source	100
Figure D-3. Lumped-component noise diode calibration schematic	101

BROADBAND SPECTRUM SURVEY AT SAN DIEGO, CALIFORNIA

Frank H. Sanders, Bradley J. Ramsey, and Vincent S. Lawrence¹

The National Telecommunications and Information Administration (NTIA) is responsible for managing the Federal Government's use of the radio spectrum. In discharging this responsibility, NTIA uses the Radio Spectrum Measurement System to collect data for spectrum utilization assessments. This report details such a data collection effort spanning all of the spectrum from 108 MHz to 19.7 GHz in the metropolitan area of San Diego, California during February and March of 1995.

Key words: land mobile radio (LMR); radar emission spectrum; radio frequency environment; Radio Spectrum Measurement System (RSMS); spectrum resource assessment; spectrum survey.

1. INTRODUCTION

1.1 Background

The National Telecommunications and Information Administration (NTIA) is responsible for managing the Federal Government's use of the radio spectrum. Part of this responsibility is to establish policies concerning spectrum assignment, allocation, and use; and to provide the various departments and agencies with guidance to ensure that their conduct of telecommunications activities is consistent with these policies [1, part 8.3]. In discharging this responsibility, NTIA 1) assesses spectrum utilization, 2) identifies existing and/or potential compatibility problems among the telecommunication systems that belong to various departments and agencies, 3) provides recommendations for resolving any compatibility conflicts that may exist in the use of the frequency spectrum, and 4) recommends changes to promote spectrum efficiency and improve spectrum management procedures.

Since 1973, NTIA has been collecting data on Federal use of the radio frequency spectrum in support of the NTIA Spectrum Analysis Program. The Radio Spectrum Measurement System (RSMS) is used by NTIA to provide technical support for 1) Spectrum Resource Assessments (SRAs), 2) U.S. participation in the International Telecommunication Union (ITU) conferences and ITU Radiocommunication Sector (ITU-R) activities, 3) analysis of electromagnetic compatibility (EMC) problems, 4) interference resolution, and 5) systems review activity related to new Federal Government systems.

¹The authors are with the Institute for Telecommunication Sciences, National Telecommunications and Information Administration, U.S. Department of Commerce, Boulder, CO 80303-3328.

1.2 Authority

The RSMS is under the administrative control of the Director of the Institute for Telecommunication Sciences (ITS), The Deputy Associate Administrator of the Office of Spectrum Management (OSM) is responsible for meeting the spectrum management requirements of NTIA, as transmitted to him by the Associate Administrator of OSM. RSMS measurement activities are authorized by the Deputy Associate Administrator of OSM in consultation with the Director of ITS. Federal agencies with spectrum management problems can request support of the RSMS through the Deputy Associate Administrator of OSM.

1.3 Purpose

Under Departmental Organizational Order 25-7, issued October 5, 1992 and amended December 3, 1993, the Office of Spectrum Management is responsible for identifying and conducting measurements necessary to provide NTIA and the various departments and agencies with information to ensure effective and efficient use of the spectrum. As part of this NTIA measurement program, spectrum occupancy measurements are conducted using the RSMS. The spectrum occupancy data presented in this report do not include identification of specific emitters. The measured data are provided for the spectrum management community to:

- ▶ enable a better understanding of how telecommunication systems use the allocated spectrum;
- ▶ provide timely information on variations in frequency-band usage, e.g., identify frequency bands becoming heavily used;
- ▶ support the NTIA system review process by providing information on the availability of spectrum for new systems; and
- ▶ assess the feasibility of promoting alternative types of services or systems that result in more effective and efficient use of the spectrum.

1.4 Extrapolation of Spectrum Occupancy Data

The spectrum survey measurements contained in this report cannot be solely used to assess the feasibility of using alternate services or systems in a band. Extrapolation of data in this report to general spectrum occupancy for alternative spectrum uses requires consideration of additional factors. These include spectrum management procedures, types of missions performed in the bands, and new spectrum requirements in the development and procurement stages. Also, measurement area, measurement site, and measurement system parameters should be considered.

The area chosen for a spectrum survey will affect measured spectrum occupancy. For example, measurements made in Denver, Colorado [2] are probably representative of many major metropolitan areas that do not have any maritime radionavigation or heavy military activity.

Other cities, such as San Diego, California, show higher levels of usage in bands that support such activities.

Choice of measurement site within an area can also affect measured spectrum occupancy. An area such as Seattle-Tacoma, Washington (rough terrain, heavy forestation, and widely dispersed transmitters) may require multiple measurement sites to adequately characterize usage.

Spectrum management procedures such as band allotments for functions and missions affect spectrum utilization. For example, channels used for taxi dispatch might show heavy use whereas channels allocated for law enforcement or public safety may show less use. Regardless of usage, dedicated channels for these safety-of-life functions remain a spectrum requirement. Special occurrences such as olympic games, natural disasters, and Presidential inaugurations also create unique spectrum requirements.

Spectrum measurements provide data on expected signal levels and probability of occurrences that are essential for assessing alternate uses of the spectrum. Such information cannot be obtained from band allocation databases or an understanding of spectrum management procedures.

2. OVERVIEW OF BROADBAND SPECTRUM SURVEYS

2.1 Introduction

Procedures for conducting a broadband spectrum survey using the RSMS are outlined in this section. Site selection factors, significant measurement system parameters, and hardware and software configurations developed for the surveys are described. Detailed information on the system hardware (including the vehicle, instrumentation, antennas, and receiver front-end), measurement software, and other measurement capabilities are provided in Appendices A and B. Measurement system response to various types of signals is described in Appendix C. RSMS calibration theory and application are described in Appendix D.

2.2 Survey Site Selection

A successful spectrum survey (also called a site survey) requires careful selection of a measurement site. Maximum signal intercept probability and minimum logistic problems are the first considerations when locating a site for an RSMS spectrum survey.

The primary signal intercept factors are 1) maximum line-of-sight coverage to increase the probability of weak signal reception such as transmissions from mobile units; 2) limited numbers of nearby transmitters to prevent intermodulation or saturation problems that can arise even though preelection and/or filtering is used for survey measurements; and 3) limited man-made noise such as impulsive noise from automobile ignition systems and electrical machinery that can add to the received signals of interest and give misleading results.

The primary logistic factors are 1) commercial power to increase the probability of completing the spectrum survey (typically two weeks of 24-hr operation) without power interruptions; 2) commercial telephone for relatively inexpensive reliable communications, compared to the RSMS cellular telephone that could possibly contaminate the measurements when transmitting; and 3) security of personnel, vehicle, and electronic hardware.

The ideal site is a well-illuminated, fenced, and patrolled area that satisfies all of the primary site selection factors above and has reasonable access to lodging for the operating personnel.

2.3 Spectrum Survey Measurements

Spectrum surveys are normally conducted for two weeks using the RSMS in an automatic mode. The measurement system is preprogrammed to continuously run software algorithms tailored to the characteristics of the radio emitters that typically occupy measured frequency sub-bands. Two decades of making such measurements in cities across the United States suggest that general patterns of spectrum occupancy tend to be repeated from site to site. Emissions from the following sources are commonly observed during RSMS spectrum surveys:

- ▶ land-mobile, marine-mobile and air-mobile communication radios;
- ▶ terrestrial, marine and airborne radars, and airborne radio altimeters;
- ▶ radionavigation emitters, such as TACAN and VOR;
- ▶ cellular and trunked communication systems;
- ▶ broadcasting transmitters such as UHF and VHF television, and multipoint distribution systems (wireless cable TV);
- ▶ industrial, scientific and medical (ISM) sources, including vehicular tracking systems, welders, and microwave ovens; and
- ▶ common carrier (point-to-point) microwave signals.

Emissions that are *not* normally receivable during spectrum surveys are:

- ▶ satellite downlink emissions;
- ▶ galactic and solar noise;
- ▶ some types of spread spectrum signals; and
- ▶ radio transmitters that are turned off.

Although the last category is self-evident, questions exist regarding the extent to which users who have assignments in the radio spectrum either do not operate, or operate very rarely, with those assignments. Appendix C discusses factors related to probability of intercept and addresses matters of measurement time vs. statistical significance of data.

As mentioned above, there are many different types of radio signals within the measurement frequency range. Each is measured with a hardware configuration and measurement algorithm specifically selected to give the most useful description of the particular type of signal(s) expected in a frequency sub-band. The measurement system parameters specially configured for each signal type include: antennas, signal conditioning, tuning speed, measurement bandwidth, detector mode, and measurement repetitions. The RSMS measurement software automatically switches the measurement system to the proper configuration for each sub-band. The measurements are repeated in various sub-bands according to specifications established by consideration of signal intercept probability, signal variability, measurement significance, and expenditure of system resources.

For spectrum surveys, the RSMS normally performs measurements of general spectrum occupancy across a frequency range of 108 MHz to 19.7 GHz. To accomplish this task, measurements are conducted in an automatic mode with the RSMS configured as two measurement systems, identified as “System-1” for frequency measurements below 1 GHz, and “System-2” for simultaneous measurements above 1 GHz.

The data acquisition (DA) measurement software provides instructions to configure each receiver system, execute measurement routines, record measured data, and maintain a real-time log of the measurements and key parameters. The measurement system configuration parameters used by the software are called “band events” and the automated band event execution procedures are called “band-event schedules.” Unattended operation of the measurement system for extended periods of time is made possible through this use of computer control. Remote control of the RSMS is also possible via a telephone modem linked to the computer. Standardized measurement schedules are used for each spectrum survey, with the measured data stored for post-measurement processing.

2.3.1 Survey Band Events

The spectrum measured by the RSMS is divided into selected frequency ranges (survey bands) that are measured according to a computer-stored list of measurement parameters and instrument settings called a band event. Each band event combines a measurement algorithm (“Swept/m3” for example) with a particular set of signal input ports, front-end configurations, spectrum analyzer (SA) modes and settings, and data-recording options. Band-event parameters and options are detailed in Appendix B. The factors considered when selecting frequency sub-bands, receiver algorithms, and other parameters for the band events are discussed in Appendix C. Spectrum survey “standard” band-event parameters for System- 1 and System-2 are shown in Tables 1 and 2, respectively.

Table 1. Spectrum Survey Band Events for RSMS System-1

Standard Events		DA Receiver Parameters						DA Spectrum Analyzer Parameters*						Antenna**	
Event Number	Freq. Band (MHz)	Algorithm	Start (MHz)	End (MHz)	Scans (# of)	Sweeps (# of)	Steps (# of)	IFBW (kHz)	Detector Type	VBW (kHz)	RL (dBm)	MH/VA (#swps)	Swp/stp (sec)	Type	Gain (dBi)
10,11***	108-162	sw/m3	104	164	6	100	1	10	sample	10	-20	1	0.3	LPA	5.5
12	162-174	sw/m3	160	180	2	500	1	10	sample	10	-20	1	0.3	LPA	5.5
13	174-216	sw/m3	170	220	1	500	1	100	sample	100	-10	1	0.02	LPA	5.8
14	216-225	sw/m3	216	225	3	60	1	3	sample	3	-30	1	0.9	LPA	5.8
15	225-400	sw/m3	225	405	6	100	1	30	sample	30	-10	1	0.09	LPA	5.9
16	400-406	sw/m3	400	406	2	60	1	3	sample	3	-10	1	0.9	LPA	6.0
17	406-420	sw/m3	400	420	2	200	1	10	sample	10	-20	1	0.9	LPA	6.0
18	420-450	stepped	420	450	1	1	30	1000	+peak	3000	-10	1	12	LPA	6.0
19	450-470	sw/m3	450	470	2	200	1	10	sample	10	-20	1	0.9	LPA	6.1
9,20***	470-512	sw/m3	470	520	5	100	1	10	sample	10	-20	1	0.9	LPA	6.1
21	512-806	sw/m3	512	812	3	200	1	100	sample	100	-10	1	0.02	LPA	6.2
22	806-902	sw/m3	806	906	10	60	1	10	sample	10	-20	1	0.3	LPA	6.2
23	902-928	swept	900	930	3	1	1	10	MXMH	10	-10	600	0.3	LPA	6.1
24	902-928	stepped	900	930	1	1	30	1000	+peak	3000	-10	1	12	LPA	6.1
25	928-960	sw/m3	920	960	4	300	1	10	sample	10	-20	1	0.3	LPA	6.1

* For spectrum surveys, attenuation is set to 0 (default), display to 10 dB/div, and the spectrum analyzer in use must measure at least 1000 points per scan.

** For the San Diego survey, all System-1 events were measured with a 100 MHz to 1 GHz log periodic antenna (LPA) mounted at a 45° angle for slant polarization (see Section A.4 of Appendix A).

*** In portions of the 108-162 MHz and 470-512 MHz bands, it was necessary to use attenuation to prevent front-end overload. This was accomplished by creating new band events (9 and 10) for the portions requiring attenuation. Thirty dB of attenuation was used for event 9, across 470-490 MHz, and 40 dB attenuation was used for event 10, across 104-114 MHz.

Table 2. Spectrum Survey Band Events for RSMS System-2

Standard Events		DA Receiver Parameters						DA Spectrum Analyzer Parameters*						Antenna**	
Event Number	Freq. Band (MHz)	Algorithm	Start (MHz)	End (MHz)	Scans (# of)	Sweeps (# of)	Steps (# of)	IFBW (kHz)	Detector Type	VBW (kHz)	RL (dBm)	MH/VA (#swps)	Swp/stp (sec)	Type	Gain (dBi)
05	960-1215	sw/m3	950	1250	1	500	1	300	+peak	3000	-10	1	0.02	omni	2.1
06	1215-1400	stepped	1200	1400	1	1	200	1000	+peak	3000	-10	1	12	omni	2.2
07	1350-1400	sw/m3	1350	1400	5	100	1	10	sample	10	-20	1	0.3	omni	2.2
08	1400-1530	sw/m3	1400	1550	5	200	1	30	sample	30	-10	1	0.09	omni	2.2
09	1530-1710	sw/m3	1530	1710	6	500	1	30	sample	30	-10	1	0.09	omni	2.2
10	1710-2300	swept	1700	2300	6	1	1	100	MXMH	100	-10	600	0.1	dish	17.5
11	2300-2500	swept	2300	2500	2	1	1	100	MXMH	100	-10	600	0.1	omni	2.5
12	2500-2700	swept	2500	2700	2	1	1	100	MXMH	100	-10	600	0.1	dish	19.8
13	2700-2900	stepped	2700	2900	1	1	200	1000	+peak	3000	-10	1	5*	omni	2.8
14	2900-3100	stepped	2900	3100	1	1	200	1000	+peak	3000	-10	1	12	omni	2.8
15	3100-3700	stepped	3100	3700	1	1	200	3000	+peak	3000	-10	1	12	omni	3.0
16	3700-4200	swept	3700	4200	5	1	1	100	MXMH	100	-10	600	0.1	dish	23.5
17	4200-4400	sw/m3	4200	4400	1	500	1	300	+peak	3000	-10	1	0.02	omni	3.0
18	4400-5000	swept	4400	5000	6	1	1	100	MXMH	100	-10	600	0.1	dish	25
19	5000-5250	sw/m3	5000	5300	1	500	1	300	+peak	3000	-10	1	0.02	omni	3.1
20	5250-5925	stepped	5250	5950	1	1	240**	3000	+peak	3000	-10	1	12	omni	3.1
21	5925-7125	swept	5926	7125	4	1	1	300	MXMH	1000	-10	600	0.1	dish	28

Table 2. Spectrum Survey Band Events for RSMS System-2 (Continued)

Standard Events		DA Receiver Parameters						DA Spectrum Analyzer Parameters*						Antenna**	
Event Number	Freq. Band (MHz)	Algorithm	Start (MHz)	End (MHz)	Scans (# of)	Sweeps (# of)	Steps (# of)	IFBW (kHz)	Detector Type	VBW (kHz)	RL (dBm)	MH/VA (#swps)	Swp/stp (sec)	Type	Gain (dBi)
22	7125-8500	swept	7100	8600	5	1	1	300	MXMH	1000	-10	600	0.1	dish	30
23	8500-10550	stepped	8500	10600	1	1	720 ⁺⁺	3000	+peak	3000	-10	1	4	omni	3.1
24	10550-13250	swept	10550	13250	1	1	1	3000	MXMH	3000	-10	600	0.1	dish	33
25	13250-14200	stepped	13250	14250	1	1	340 ⁺⁺	3000	+peak	3000	-10	1	4	omni	2.8
26	14200-15700	swept	14200	15700	1	1	1	3000	MXMH	3000	-10	600	0.1	dish	35
27	15700-17700	stepped	15700	17700	1	1	700 ⁺⁺	3000	+peak	3000	-10	1	4	omni	2.7
28	17700-19700	swept	17700	19700	1	1	1	3000	MXMH	3000	-10	600	0.1	dish	37

∞

* For spectrum surveys, attenuation is set to 0 (default), display to 10 dB/div, and the spectrum analyzer in use must measure at least 1000 points per scan.

** A parabolic (dish) antenna is used for azimuth scanning (i.e., "rotating dish" measurements only). See Sections A.4 and B.2 of Appendices A and B, respectively for descriptions of the antennas and the swept/azimuth-scanning algorithm used with the dish antenna.

+ An increased step time (dwell) may be used to characterize slow rotation-emitters (e.g., weather radars) if they are contributing a significant part of the measured occupancy.

++ The number of steps given is the minimum necessary to ensure full coverage in the measurement bandwidth selected for this event. Since this band has been well-characterized by previous RSMS measurements, fewer steps were used for the San Diego survey to save measurement time for higher priority band events.

Each row in the tables, beginning with an event number, shows the measurement parameters for a specific receiver configuration in the RSMS. Instruction to run the event can come from an operator or from a computer-loaded band-event schedule as explained in Section 2.3.2. The DA software, when instructed, sends the command parameters for an event to the system hardware and initiates measurements for the event. The tables (Table 1 and Table 2) are subdivided into four parts: 1) “Standard Events” identifies the event number and exact frequency range of interest, 2) “DA Receiver Parameters” shows input values for receiver configuration subroutines, 3) “DA Spectrum Analyzer Parameters” lists configuration command values sent to the spectrum analyzer, and 4) “Antenna” identifies the type and gain of the antenna selected for the event. Appendix B describes DA software configuration routines and the associated table parameters found in 2) and 3) above.

2.3.2 Band-Event Schedules

Using RSMS measurement control software, any band event can be executed by an operator at any time. For spectrum surveys, many band events are used to span several gigahertz of spectrum and each event requires a different amount of time to execute. DA software also includes an automated band-event execution mode where any of the band events may be programmed (scheduled) to execute in any sequence for any amount of time (within hardware limits on continuous operation of the measurement system).

There are two types of schedules used for spectrum surveys with the RSMS: a standard band-event schedule of all the survey bands, or a special band-event schedule for a few selected survey bands. For example, if a survey was conducted in a port city, a special schedule might include only survey bands with assignments for maritime communications (this was not, however, done in San Diego). Any number of special schedules can be run during a survey.

Tables 3 and 4 show the standard band-event schedules for RSMS System-1 and System-2, respectively. Tables 5 and 6 show special band-event schedules for measurements in survey bands expected to show altered usage during adverse weather. The tables include: 1) schedule number;² 2) band-event number (specifies which band event to “run” in the schedule); 3) priority number (value assigned to the band-event data, with (1) being the highest priority); 4) event time (approximate time in minutes needed to run the event); and 5) accumulative time (approximate time in hours that the sequence has run).

Band-event priority is an important consideration when scheduling standard band events; i.e., some frequency bands in a spectrum survey are of more interest to spectrum managers than others. In fact, an important part of the preparation for a spectrum survey is a review of local frequency assignments and allocations. From this preliminary information, measurement parameters may be modified and band-event priority numbers (1, 2, or 3, with 1 being highest priority) adjusted to optimize survey data.

²This is a sequence number used by the scheduling subroutine. Only 64 band events may be sequenced, but there is no limit on how many times the sequence runs during a survey.

Table 3. Standard Band-Event Schedule for RSMS System-1

Schedule Number	Band Event Number	Priority Number	Event Time (minutes)	Accumulative Time (hours)
1	12	1	16.3	0.27
2	10	2	1.7	0.30
3	11	2	8.6	0.44
4	17	1	10.8	0.62
5	14	2	5.1	0.71
6	13	3	5.8	0.81
7	19	1	10.8	0.99
8	22	2	10.8	1.17
9	9	1	5.5	1.26
10	20	1	8.3	1.40
11	23	2	5.3	1.48
12	25	1	20.0	1.82
13	18	2	6.7	1.93
14	12	1	16.3	2.20
15	16	3	3.4	2.26
16	17	1	10.8	2.44
17	24	2	6.7	2.55
18	19	1	10.8	2.73
19	10	2	1.7	2.76
20	11	2	8.6	2.90
21	9	1	5.5	2.99
22	20	1	8.3	3.13
23	14	2	5.1	3.22
24	25	1	20.0	3.55
25	21	3	7.3	3.67
26	12	1	16.3	3.94
27	22	2	10.8	4.12
28	17	1	10.8	4.30
29	23	2	5.3	4.39
30	15	3	8.3	4.53
31	19	1	10.8	4.71
32	18	2	6.7	4.82
33	9	1	5.5	4.91
34	20	1	8.3	5.05
35	24	2	6.7	5.16
36	25	1	20.0	5.50

Table 4. Standard Band-Event Schedule for RSMS System-2

Schedule Number	Band Event Number	Priority Number	Event Time (minutes)	Accumulative Time (hours)
1	05	3	5.6	0.09
2	06	3	42.0	0.79
3	07	2	8.6	0.94
4	08	2	12.7	1.15
5	09	1	37.2	1.77
6	11	3	3.0	1.82
7	13	3	18.0	2.12
8	14	2	42.0	2.82
9	15	2	42.0	3.52
10	17	3	5.6	3.61
11	19	3	5.6	3.71
12	20	2	49.0	4.52
13	23	2	49.0	5.34
14	25	1	25.0	5.76
15	27	1	52.0	6.62
16	05	3	5.6	6.72
17	09	1	37.2	7.34
18	17	3	5.6	7.43
19	19	3	5.6	7.52
20	25	1	25.0	7.94
21	27	1	52.0	8.81
22	05	3	5.6	8.90
23	07	2	8.6	9.04
24	08	2	12.7	9.25
25	09	1	37.2	9.87
26	11	3	3.0	9.92
27	14	2	42.0	10.62
28	15	2	42.0	11.32
29	17	3	5.6	11.42
30	19	3	5.6	11.51

Table 5. Adverse Weather Band-Event Schedule for RSMS System-1

Schedule Number	Band Event Number	Priority Number	Event Time (minutes)	Accumulative Time (hours)
1	12	1	16,3	0.27
2	11	2	10,3	0.44
3	12	1	16.3	0.72
4	14	2	5.1	0.80

Table 6. Adverse Weather Band-Event Schedule for RSMS System-2

Schedule Number	Band Event Number	Priority Number	Event Time (minutes)	Accumulative Time (hours)
1	09	1	37.2	0.62
2	23	2	49,0	1.44
3	05	3	5.6	1.53
4	17	3	5.6	1.62
5	20	2	49.0	2.44
6	14	2	42.0	3.14
7	13	3	18.0	3.44

Highly dynamic bands (where occupancy changes rapidly) include those used by mobile radios (land, marine, and airborne) and airborne radars. These bands preassigned a high priority and measured often during a spectrum survey in order to maximize opportunities for signal detection. Bands that are not very dynamic in their occupancy (such as those occupied by commercial radio and television signals or fixed emitters such as air traffic control radars) need not be observed as often, because the same basic occupancy picture will be generated every time. Such bands are given a low priority and less measurement time. An extreme case is that of the common carrier bands, which are essentially nondynamic. Generally, these are only measured once during a survey and are not included in the band-event schedules.

The standard band-event schedules are usually arranged to execute priority 1 events three times more often than priority 3 events. However, some adjustment to this arrangement may be necessary to accommodate total time required to complete the sequenced band-event schedule. For example, if less than two weeks of measurement time were available, a time-consuming priority 1 event (such as Band Event 27; 15.7-17.7 GHz) might not be run three times as often as priority 3 events to ensure that all bands would be measured.

Because of the many land mobile radio (LMR) bands below 1 GHz, System-1 scheduling reflects some preplanning for time-of-day analysis. The sequenced schedule is prepared so that all events will be run within an 8-hr period; such that, after a few days of 24-hr data collection certain LMR bands will be measured at least once during each hour.

3. SAN DIEGO SPECTRUM SURVEY

3.1 Introduction

This section 1) describes the measurement site selected for a spectrum survey in the San Diego, California area; 2) briefly describes the data processing used to characterize spectrum occupancy across the 108-MHz to 19.7-GHz frequency range; and 3) presents the measured data.

3.2 Measurement Site Description

The RSMS was parked on Point Loma, west of Catalina Drive, about 40 m southwest of the Cabrillo National Monument upper maintenance building and directly above Battery Ashburn. The location was about 9.5 km (6 mi) west-by-southwest of downtown San Diego, on property owned by the U.S. Navy. The site coordinates were 117°14'38.2" W, 32°40'39.8" N. Base altitude was 116 m MSL. The only structure at the site that was higher than the RSMS antennas was a mast (made of metal and approximately 2 ft in diameter) about 15 m high and about 80 m from the RSMS.

The site was well removed from fixed RF transmitters and man-made noise sources such as vehicular traffic. Mobile communications originating on Point Loma were primarily associated with the Cabrillo Monument maintenance staff, the Navy Public Works Center, and security patrols. Figure 1 shows the location of the RSMS in the San Diego area. Figure 2 shows areas that were line-of-sight (white) to the RSMS from 2 m above ground (typical mobile antenna height) and those areas that were obstructed (shaded with plus (+) signs) from the RSMS due to terrain. Figure 3 shows the RSMS deployed at Point Loma.

The San Diego metropolitan area occupies a low coastal zone that is bounded by high mountains to the east, and rough but lower terrain to the north. It adjoins the city of Tijuana, Mexico on the southern side of the U.S./Mexico border. Prominent physical features in the area include Mission Bay, San Diego Bay, and a large peninsula, named North Island, forming one side of San Diego Bay. North Island and the bays support extensive naval, commercial shipping, and aviation activities that contribute to spectrum usage. (For example, America's Cup qualifying races were being held near Point Loma; during one race, a rescue operation requiring radio communications occurred). Urban development in the area is extensive. Figure 2 shows that the RSMS survey location on Pt. Loma afforded mostly unbroken line-of-sight coverage of the San Diego metropolitan area. Line-of-sight coverage over the ocean extended to a radius of about 40 km (24 mi) from the RSMS location on the Point.

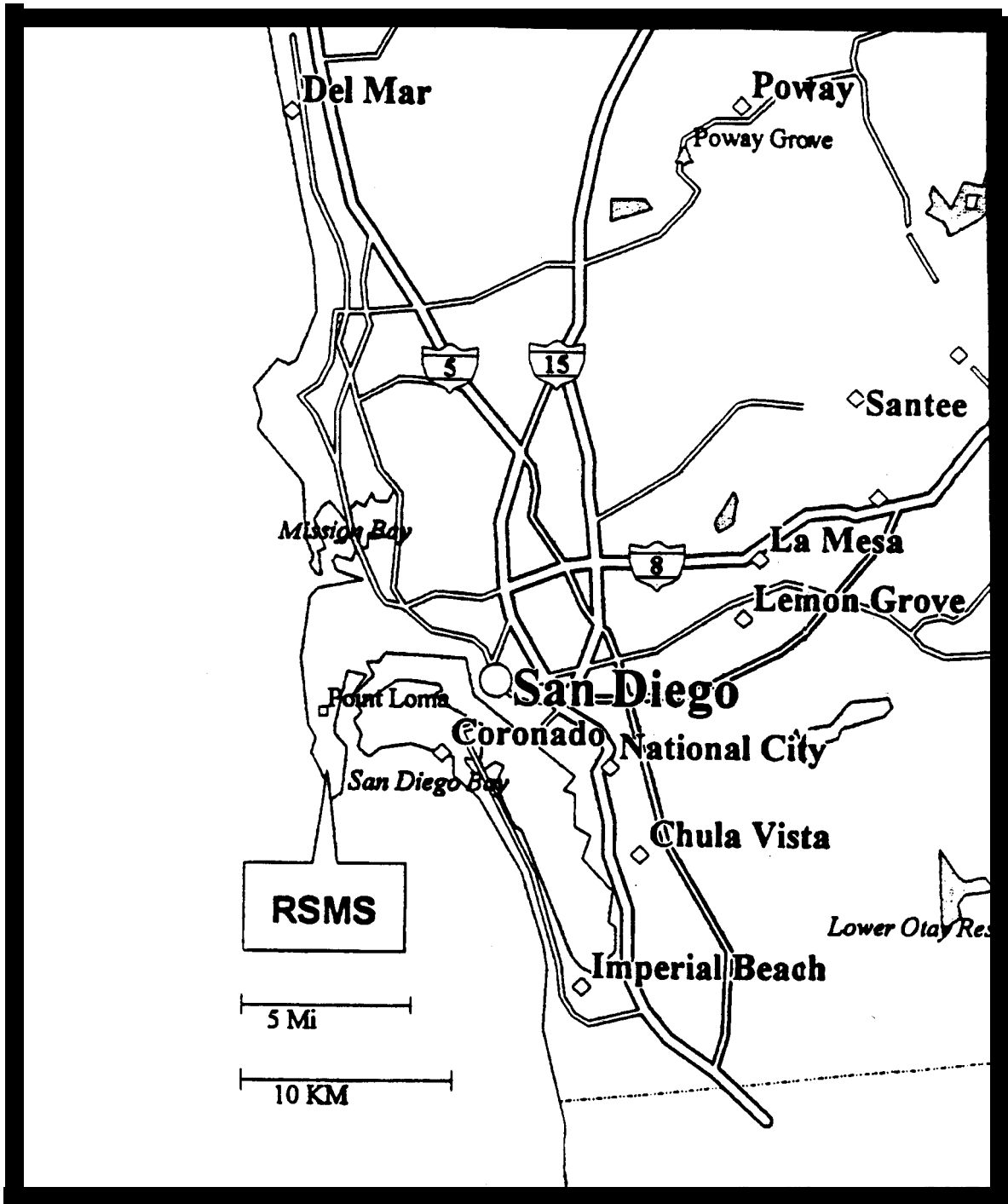

Figure 1. Area map of San Diego, California showing the location of the RSMS on Point Loma. Map produced with MapExpert™ software from DeLorme Mapping.

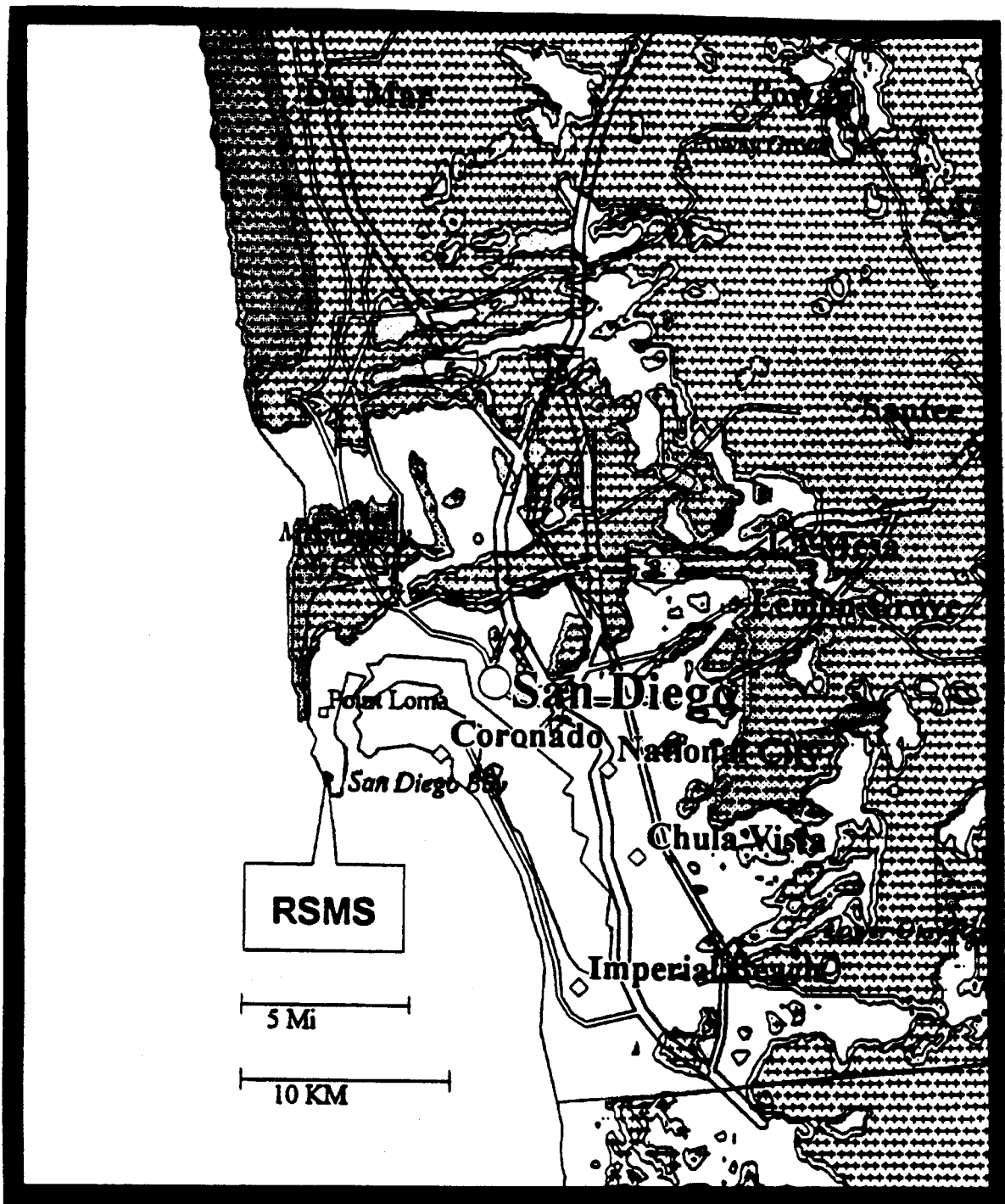

Figure 2. Area map of San Diego, California showing regions that are line-of-sight (white) and nonline-of-sight (terrain shadowed) from the RSMS raised antennas. Terrain shadowing overlay provided by ITS Telecommunications Analysis Services.

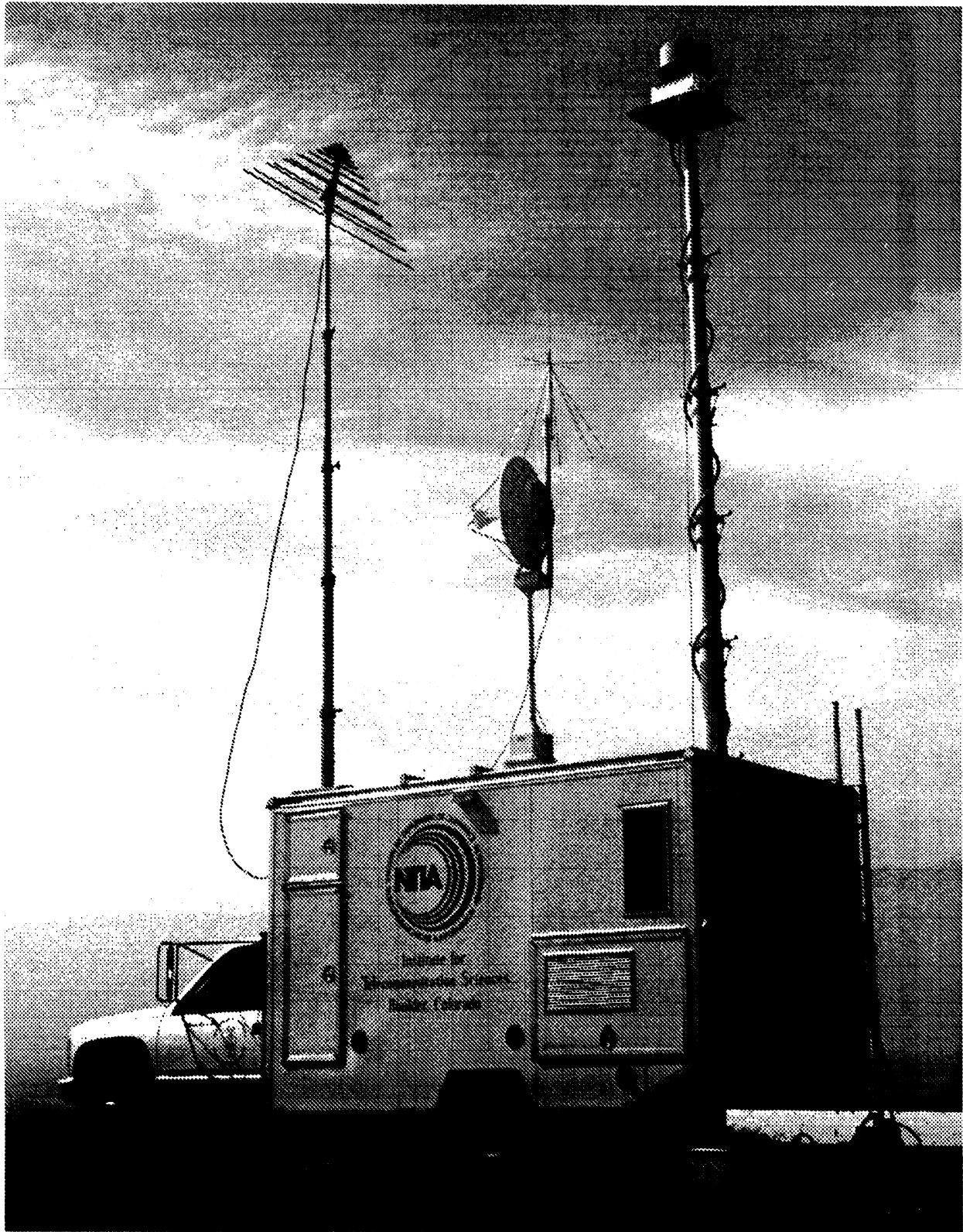

Figure 3. ITS Radio Spectrum Measurement System at Point Loma, San Diego, California.

Also shown in Figure 2, RSMS coverage included much of the Tijuana area. Most spectrum usage in Tijuana is thought to occur below 1 GHz. The RSMS measurements in this frequency range were performed with a 6-dBi gain log periodic antenna pointed toward downtown San Diego, thus enhancing RSMS reception of San Diego-area signals relative to signals from Tijuana. However, the spectrum occupancy data from San Diego undoubtedly (and unavoidably) also contain some Tijuana usage, particularly below 1 GHz.

3.3 Data Considerations

The San Diego survey was performed as outlined in Section 2. The band-event tables (Table 1 for System- 1 and Table 2 for System-2) in Section 2.3.1 list the measurement system parameters used for each survey band. Appendix C contains explanations of the measurement algorithm selections. All survey bands for System- 1 were measured with a 100-MHz to 1-GHz log periodic antenna (LPA) mounted at a 45° angle (for slant polarization) on the small mast and aimed toward downtown San Diego. The System-2 survey bands (except for azimuth-scanning bands³) were measured with a 500-MHz to 18-GHz slant polarized biconical omni antenna mounted on the large mast. For the azimuth-scanning survey bands (event numbers 10, 12, 16, 18, 21, 22, 24, 26, and 28) a rotating 1-m Tecom dish (dual horizontal/vertical feed) antenna was used. See Appendix A for more on antennas and RF front-end hardware configurations.

All of the measured data, except the azimuth-scanning measurements previously mentioned, underwent an additional cumulative processing (cuming) step before being displayed. Every frequency data point recorded for Swept/m3 measurements was cumulated (cumed) such that the graphed data points (received signal levels; RSLs) show the maximum of maximum RSLs, mean of mean RSLs, and minimum of minimum RSLs (see Section C.3.1 of Appendix C for a discussion of Swept/m3 cumulative processing). Cuming of Stepped and Swept measurements results in graphs showing maximum, mean, and minimum RSLs of all scans. On all graphs of cumed data, maximum and minimum curves are drawn with solid lines and mean curves with dashed lines.

The data collection rate for the San Diego survey was increased by decreasing the number of steps used to measure some survey bands (specifically, band events 20, 23, 25, and 27). This change was made to assess the trade-off between reduced steps and accelerated measurement rate. The reduced-step results are comparable to those of RSMS surveys performed in these bands during the last twenty years.

Strong received signal levels from FM radio broadcast stations below 108 MHz generated intermodulation products in the normally configured RSMS front-end. To eliminate such responses, 40 dB of attenuation was inserted at the RF front-end for measurements below 114 MHz. This desensitized the RSMS measurements by 40 dB at these frequencies.

³The azimuth-scanning measurement routine is a special operator-interactive technique using a rotating dish antenna with the DA Swept measurement algorithm. See Sections B.2 and C.8 in Appendices B and C for more about scanning.

Consequently, the possibility of receiving measurable signals in this range (such as instrument-landing system glideslope transmissions) was greatly reduced. However, a signal at 109.8 MHz was still detected. Similarly, commercial television broadcast signals forced the addition of 20 dB attenuation in the 174-216 MHz range and 30 dB additional attenuation in the 470-490 MHz range.

3.4 Measured Data

Each survey band of measured data is graphically displayed on a single page along with corresponding frequency allocations and assignment information (Figures 4-43). Each survey-band figure has an identical format. The principal band-event parameters and measurement location are included in the figure caption. The survey-band graphs in the middle of the page show frequency in megahertz on the x-axis vs. received signal level marked at 5-dBm increments on the y-axis. Noise level tick marks on the y-axis of some graphs (e.g., “avg sample noise” and “rein sample noise” on Figure 4) show measurement noise limits. Measurement system noise and system response to various types of signals are described in Appendix C.

The text above each graph (delimited by horizontal and vertical lines) shows the applicable U.S. Government and non-Government frequency allocations and corresponding typical user information (general utilization) for the survey band. The vertical lines delimit, by frequency, both the allocations and the measured survey-band graph on the same page.

The frequency allocations (services) are entered according to convention just as they appear in the “U.S. Government Table of Frequency Allocations” [1, part 4. 1.3]. Briefly summarized: the names of primary services are printed in capital letters; secondary services are printed in normal upper and lower case; and where the allocated service is followed by a function in parenthesis, the allocation is limited to the function shown.

The vertical lines are placed according to frequency separations in the allocation tables. The frequencies are written at the lower end of the vertical lines and are always in megahertz. Any service entry that does not fit within the line-delimited space above the graph is given a number referencing the complete allocation text below the graph on the same page. If there is additional information pertinent to a specific Government or non-Government allocation, it is indicated by a number referencing a note below the graph. General utilization, i.e., typical assignment usage notes (for the Government or non-Government allocations that fall between the same vertical line delimiters) also have a reference number if insufficient space is available. All notes are written in simple text format distinguishable from the allocated service entries that are entered according to convention as explained above.

It should be noted that the appearance of survey-band graphs is substantially affected by the measurement parameters and the analysis techniques employed. For example, data in Figures 5 and 6 were measured with similar techniques; but, Figure 5 appears to show a denser signal population than Figure 6. Closer examination shows that Figure 5 covers twice the frequency range of Figure 6 and this may be a primary reason for the apparently denser signal environment of Figure 5. Similarly, various band events may be plotted with different amplitude scales or

GOVERNMENT ALLOCATIONS:	AERONAUTICAL RADIONAVIGATION.	AERONAUTICAL MOBILE.		AERONAUTICAL MOBILE.		AERONAUTICAL MOBILE.		4.
NON-GOVERNMENT ALLOCATIONS:	AERONAUTICAL RADIONAVIGATION.	AERONAUTICAL MOBILE.	1.	AERONAUTICAL MOBILE.	3.	AERONAUTICAL MOBILE.	3.	4.
GENERAL UTILIZATION:	VHF Omnidirectional Range (VOR).	Air Traffic Control.	1.	Air Traffic Control (ATC).	2.	Air Traffic Control.		5.

19

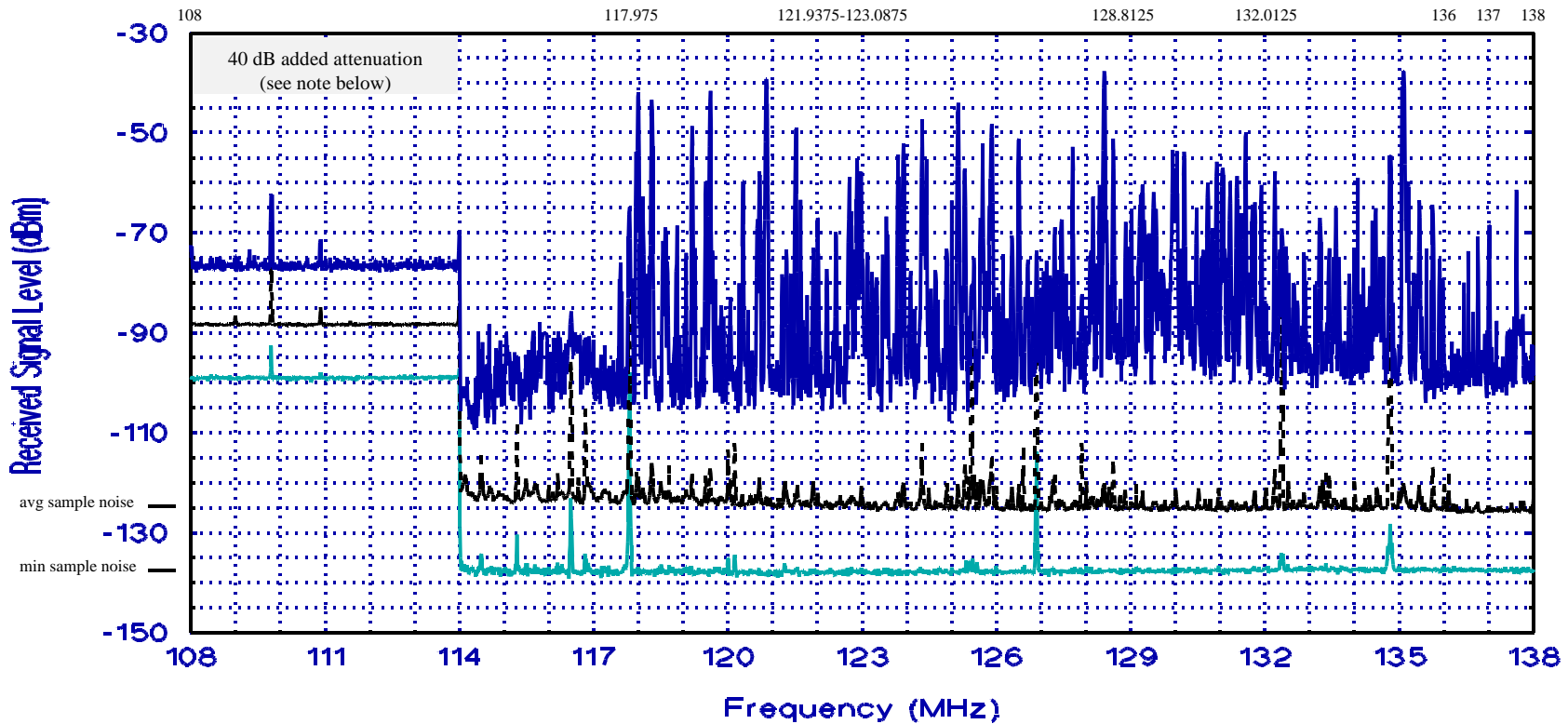

Note: Concerning 108-114 MHz attenuated data, see comments in Table 7 (Section 3.5.1).

1. AERONAUTICAL MOBILE. Private aircraft.
2. 123.1 MHz: SAR (search and rescue) operations.
3. AERONAUTICAL MOBILE.

4. SPACE OPERATION (space-to-Earth), METEOROLOGICAL-SATELLITE (space-to-Earth), SPACE RESEARCH (space-to-Earth), 137-137.025 MHz and 137.175-137.825 MHz: MOBILE-SATELLITE, 137.025-137.175 MHz and 137.825-138: Mobile-Satellite.
5. Government use includes TIROS downlinks; non-Government includes nongeostationary nonvoice mobile satellite systems (Little LEOS).

Figure 4. NTIA spectrum survey graph summarizing 7,000 sweeps across the 108-138 MHz range (System-1, band event 11, swept/m3 algorithm, sample detector, 10-kHz bandwidth) at San Diego, CA, 1995.

GOVERNMENT ALLOCATIONS:	FIXED, MOBILE.			FIXED, MOBILE. 3.	5,6.		8.		
NON-GOVERNMENT ALLOCATIONS:		AMATEUR, 2.	AMATEUR.	3.	5.	LAND MOBILE.	8.	LAND MOBILE.	9.
GENERAL UTILIZATION:	Non-tactical military land mobile communications. 1.			4.	7.	Land transportation, public safety, industrial, Earth telecommand, etc.		Land transportation, public safety, industrial, etc.	

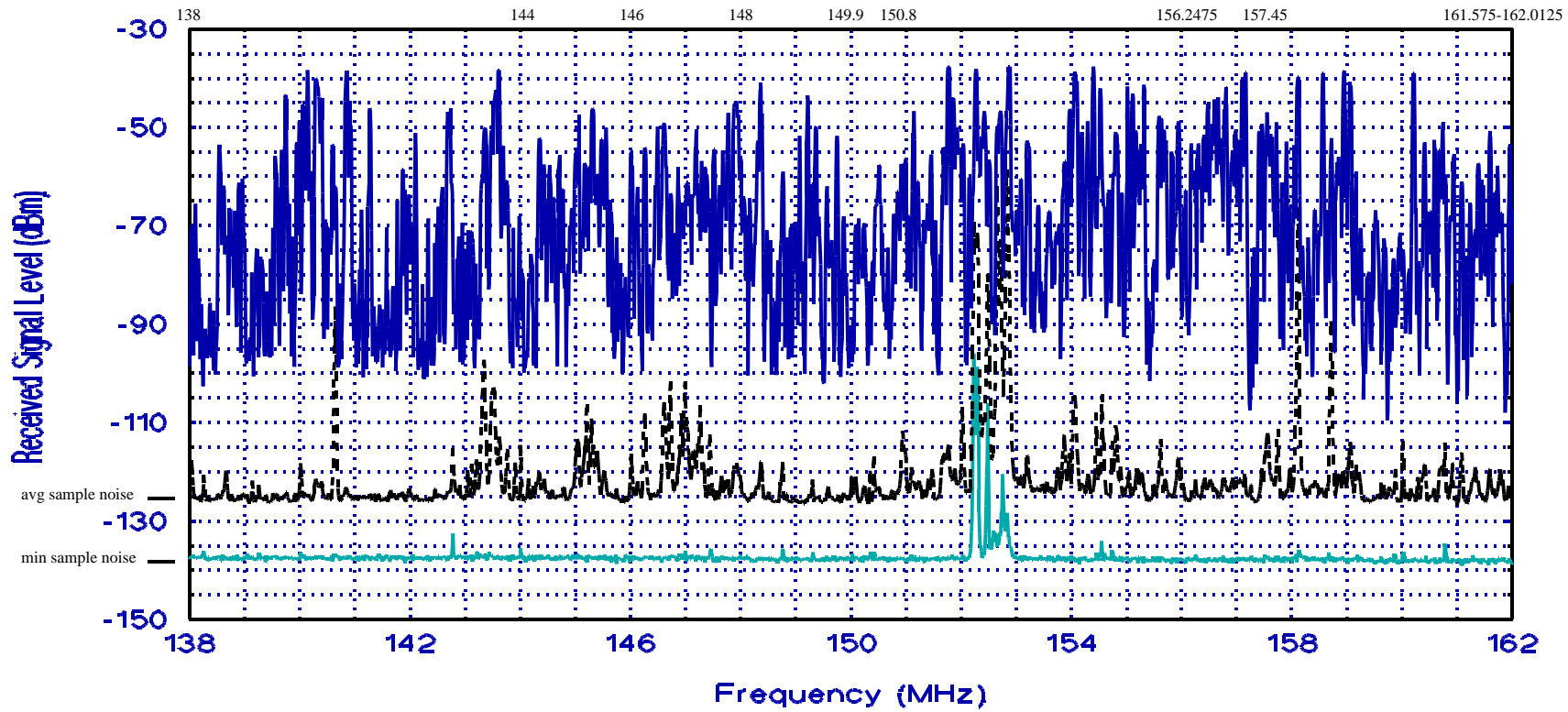

- | | |
|-------------------------------------------------------------------------------------------------------------------------------------------------------------------------------------------------------------------------------------------------------------|--------------------------------------------------------------------------------------------------------------------------------------------------------|
| 1. 143.75 MHz and 143.9 MHz: Civil Air Patrol. | 5. 149.9-150.05 MHz: RADIONAVIGATION-SATELLITE, MOBILE-SATELLITE (Earth-to-space). |
| 2. AMATEUR-SATELLITE. | 6. 150.05-150.8 MHz: FIXED, MOBILE. |
| 3. MOBILE-SATELLITE (Earth-to-space). | 7. Government use includes military non-tactical mobile and fixed communications and TRANSIT-SAT downlinks. Non-Government use includes "Little LEOS." |
| 4. Non-tactical military land mobile communications. 148.15 MHz: Civil Air Patrol. Government use includes TIROS command links and NASA satellite operations. Non-Government use includes nongeostationary nonvoice mobile satellite systems (Little LEOS). | 8. MARITIME MOBILE. 157.0375-157.1875 MHz: Govt only, VHF distress systems communications. |
| | 9. MARITIME MOBILE. 161.625-161.775 MHz: LAND MOBILE. |

Figure 5. NTIA spectrum survey graph summarizing 7,000 sweeps across the 138-162 MHz range (System-1, band event 11, swept/m3 algorithm, sample detector, 10-kHz bandwidth) at San Diego, CA, 1995.

GOVERNMENT ALLOCATIONS:	FIXED, MOBILE	3.	
NON-GOVERNMENT ALLOCATIONS:		1.	
GENERAL UTILIZATION:	Land Mobile Radio (LMR) including weather radio, public safety, and law enforcement.	2.	

162.0125

173.2-173.4 174

21

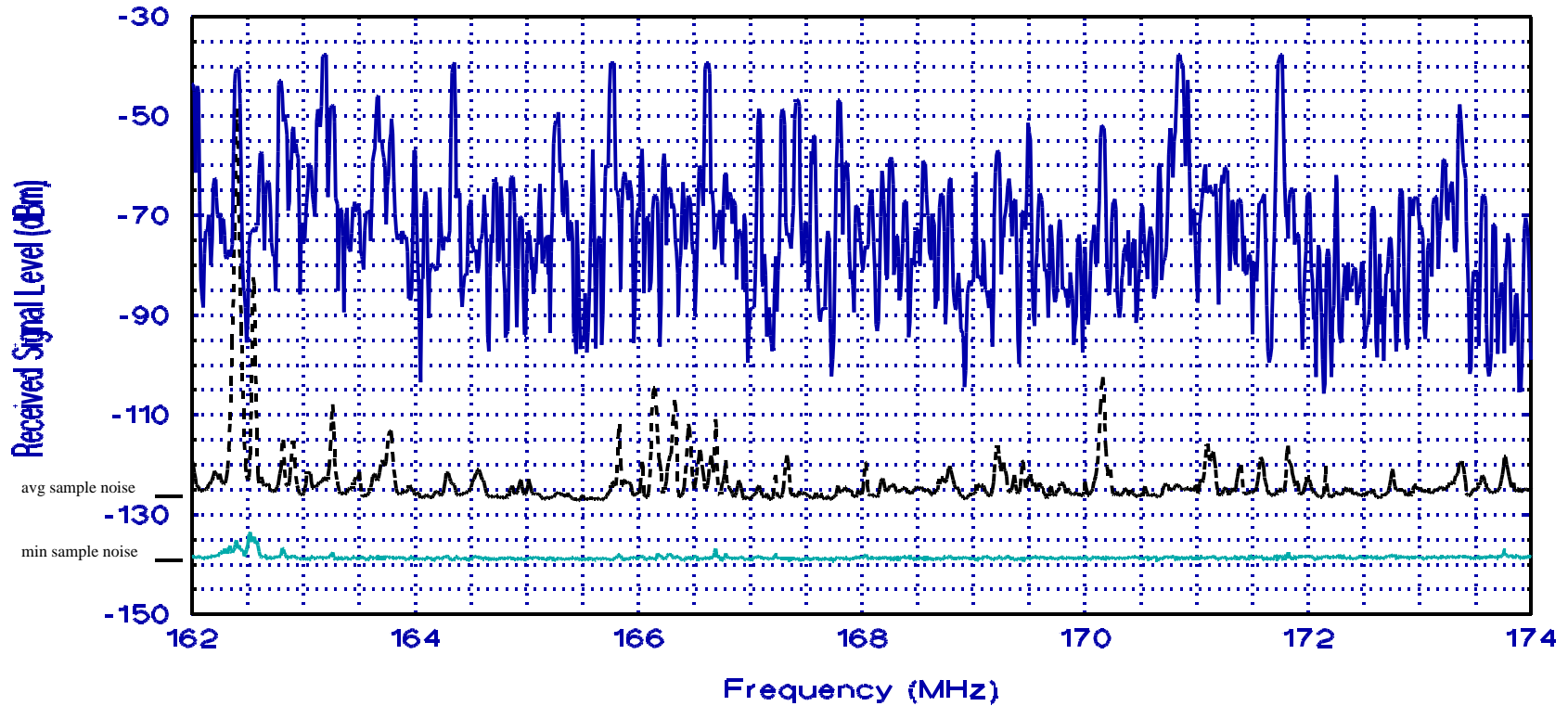

- 1. FIXED, Land Mobile.
- 2. Industrial, public safety.

- 3. FIXED, MOBILE.

Figure 6. NTIA spectrum survey graph summarizing 52,500 sweeps across the 162-174 MHz range (System-1, Band Event 12, swept/m3 algorithm, sample detector, 10-kHz bandwidth) at San Diego, CA, 1995.

GOVERNMENT ALLOCATIONS:								
NON-GOVERNMENT ALLOCATIONS:	BROADCASTING (television broadcasting), 1, 2.							
GENERAL UTILIZATION:	Channel 7	Channel 8	Channel 9	Channel 10	Channel 11	Channel 12	Channel 13	
	174	180	186	192	198	204	210	216

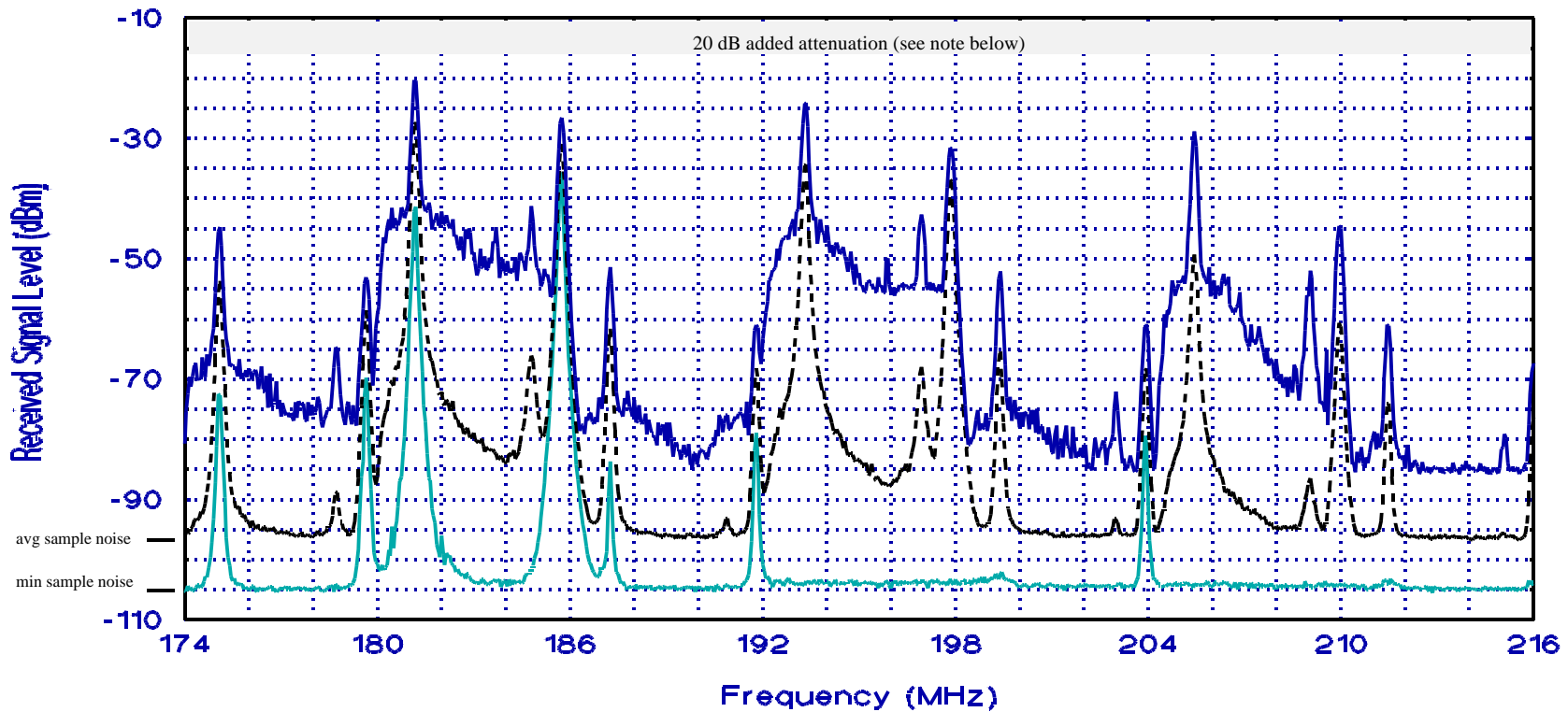

Note: Concerning 174-216 MHz attenuated data, see comments in Table 7 (Section 3.5.1).

2. TV broadcast licences are permitted to use subcarriers on a secondary basis for both broadcast and non-broadcast purposes.

1. Subscription television services and limited wireless microphone operations are also permitted in this band.

Figure 7. NTIA spectrum survey graph summarizing 18,500 sweeps across the 174-216 MHz range (System-1, band event 13, swept/m3 algorithm, sample detector, 100-kHz bandwidth) at San Diego, CA, 1995.

GOVERNMENT ALLOCATIONS:	MARITIME MOBILE, Radiolocation, Fixed, Aeronautical Mobile, 1, 2.	LAND MOBILE, Radiolocation, 1.	Radiolocation, 1.
NON-GOVERNMENT ALLOCATIONS:	MARITIME MOBILE, Fixed, Radiolocation, Aeronautical Mobile, 2.	LAND MOBILE.	AMATEUR.
GENERAL UTILIZATION:	Automated maritime telecommunications systems.	Trunked and conventional systems.	Amateur (1.25 meters).

216

220

222

225

23

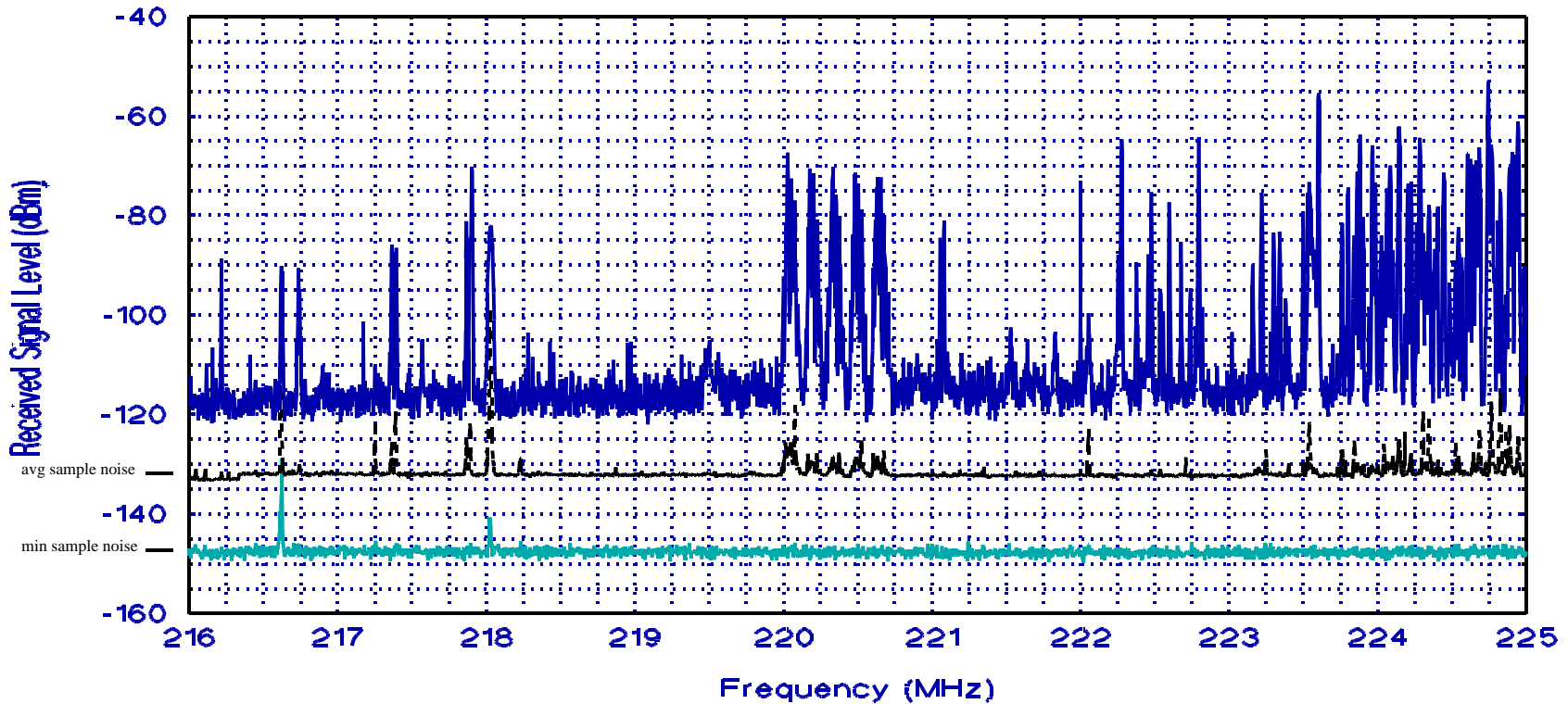

1. Radiolocation is limited to the military services.

2. Secondary services, other than radiolocation, are generally limited to telemetering and associated telecommand operations.

Figure 8. NTIA spectrum survey graph summarizing 4,020 sweeps across the 216-225 MHz range (System-1, band event 14, swept/m3 algorithm, sample detector, 3-kHz bandwidth) at San Diego, CA, 1995.

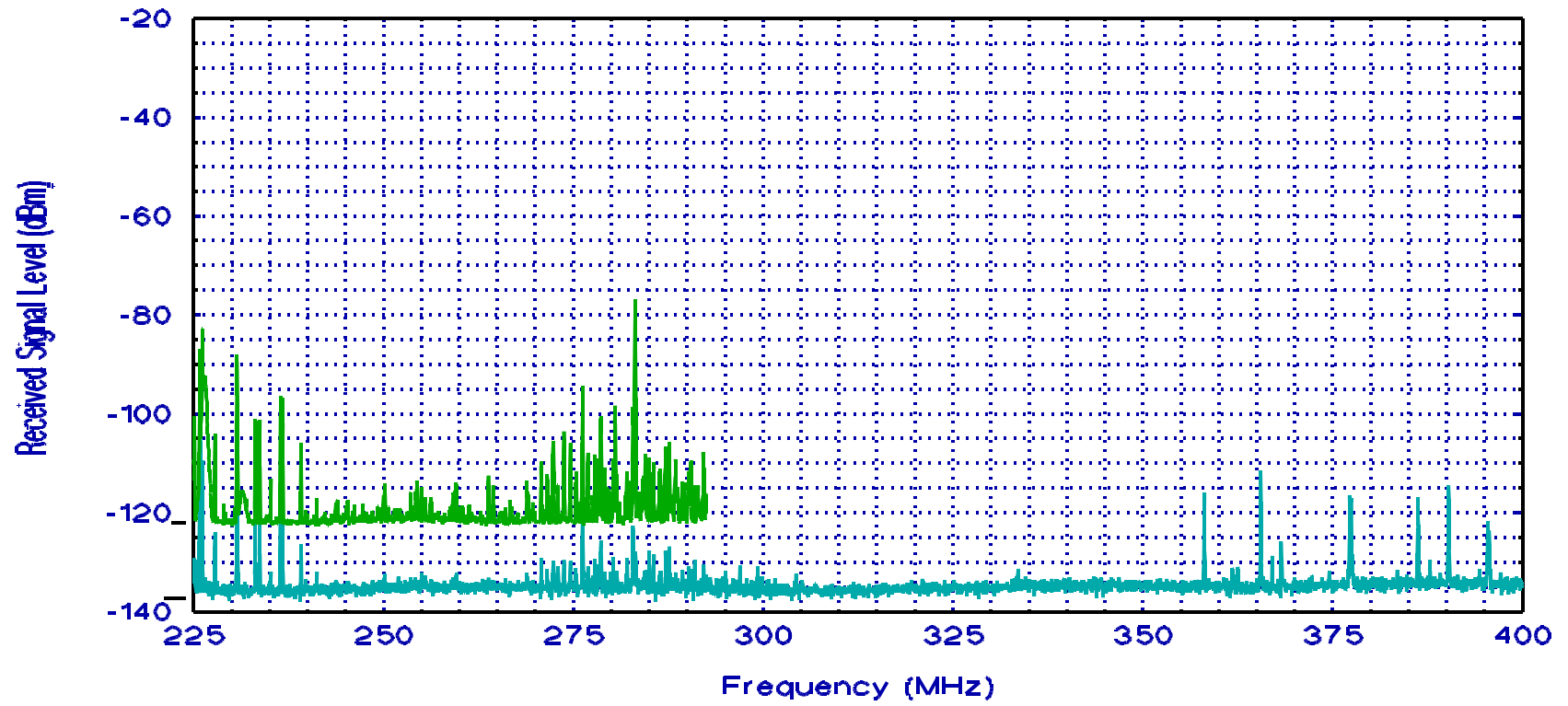

GOVERNMENT ALLOCATIONS:	1.	METEOROLOGICAL AIDS (Radiosonde), 2, 3, 4, 5.	
NON-GOVERNMENT ALLOCATIONS:	1.	METEOROLOGICAL AIDS (Radiosonde), 3, 4, 5.	
GENERAL UTILIZATION:	1.	Meteorological radiosondes and satellite communication including GOES and TIROS-N.	

400.05-400.15

406

25

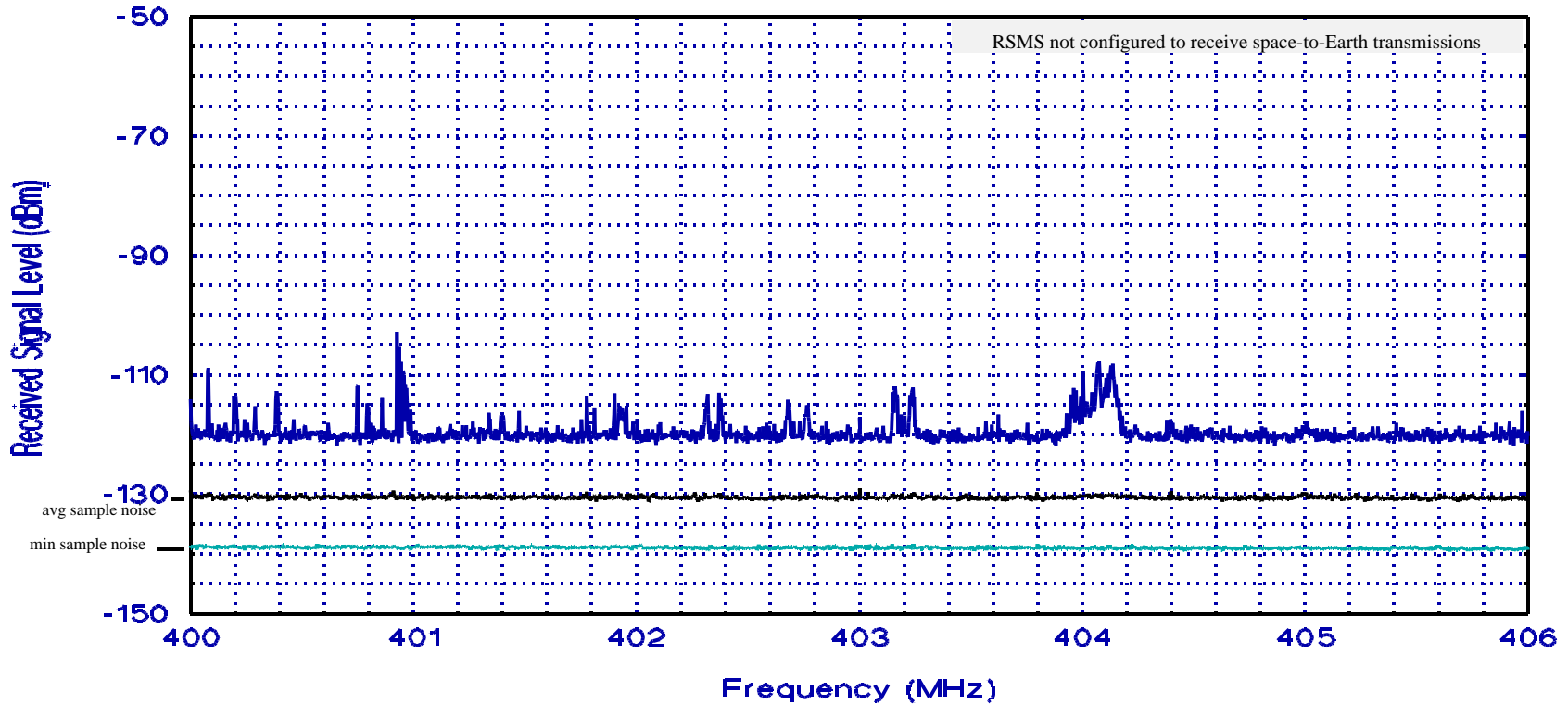

- | | |
|--------------------------------------------------------------------------------------------------------------------------|---------------------------------------------------------------------------------------------------------------------------------------------|
| 1. STANDARD FREQUENCY AND TIME SIGNAL-SATELLITE (400.1 MHz \pm 25 kHz). | 4. 401-402 MHz: SPACE OPERATION (space-to-Earth), Earth Exploration-Satellite (Earth-to-space), Meteorological-Satellite. (Earth-to-space). |
| 2. 400.15-401 MHz: METEOROLOGICAL-SATELLITE (space-to-Earth). | 5. 402-403 MHz: Earth Exploration-Satellite (Earth-to-space), Meteorological-Satellite (Earth-to-space). |
| 3. 400.15-401 MHz: SPACE RESEARCH (space-to-Earth), MOBILE-SATELLITE (space-to-Earth), Space Operation (space-to-Earth). | |

Figure 10. NTIA spectrum survey graph summarizing 2,040 sweeps across the 400-406 MHz range (System-1, band event 16, swept/m3 algorithm, sample detector, 3-kHz bandwidth) at San Diego, CA, 1995.

GOVERNMENT ALLOCATIONS:	1	FIXED, MOBILE, RADIO ASTRONOMY, 2.	FIXED, MOBILE, Space Research (space-to-space), 2.	
NON-GOVERNMENT ALLOCATIONS:	1	RADIO ASTRONOMY.		
GENERAL UTILIZATION:	1	LMR, 2.	LMR, 2.	

406-406.1

410

420

26

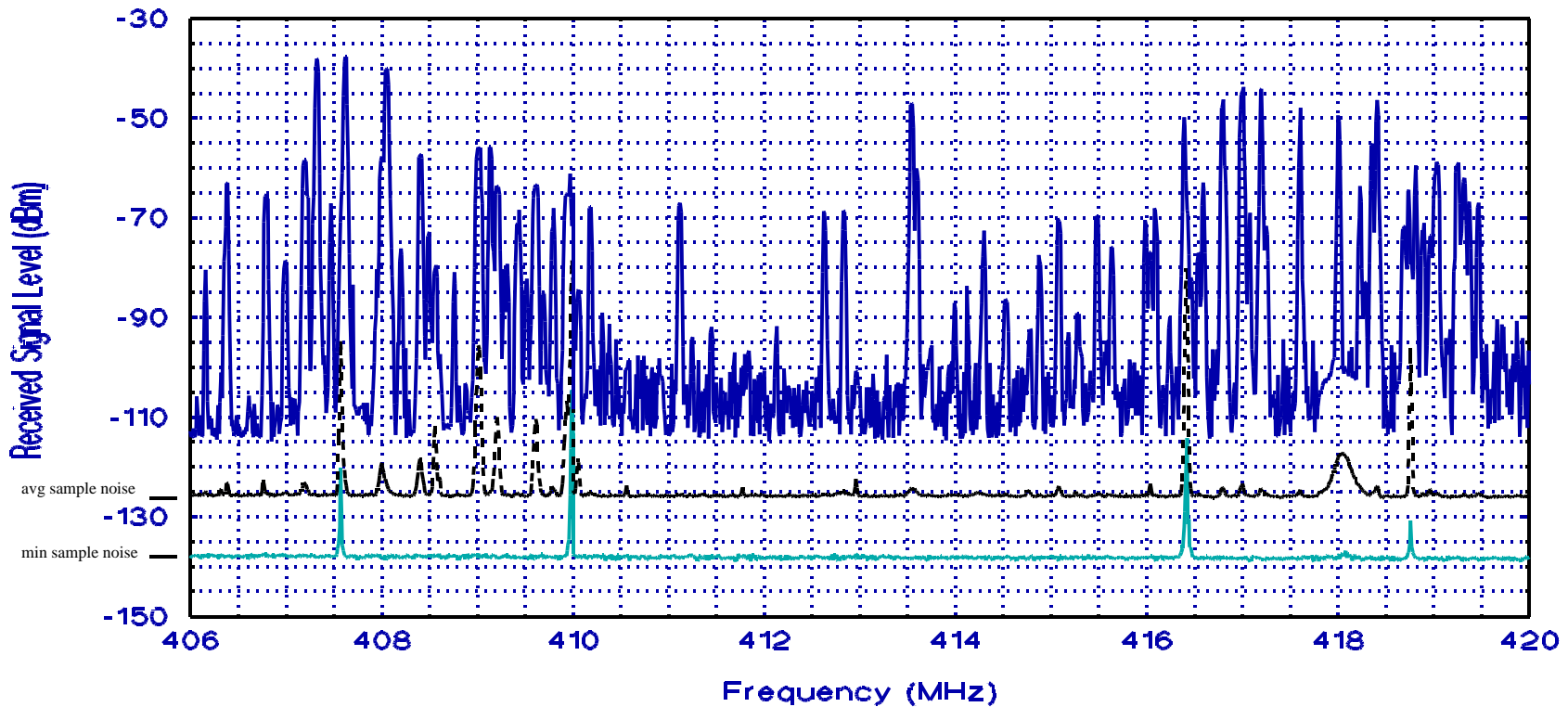

1. MOBILE-SATELLITE (Earth-to-space). Low power satellite emergency position-indicating radiobeacons (EPIRB) only. Supported by the joint U.S. SARSAT/Russian COSPAS satellite network.

2. Fixed and mobile services are allocated for Government nonmilitary agencies. Military use may be authorized on a local-coordinated, secondary, noninterfering basis.

Figure 11. NTIA spectrum survey graph summarizing 20,600 sweeps across the 406-420 MHz range (System-1, band event 17, swept/m3 algorithm, sample detector, 10-kHz bandwidth) at San Diego, CA, 1995.

GOVERNMENT ALLOCATIONS:	RADIOLOCATION.
NON-GOVERNMENT ALLOCATIONS:	Amateur.
GENERAL UTILIZATION:	Long-range surveillance radars, 1, 2.

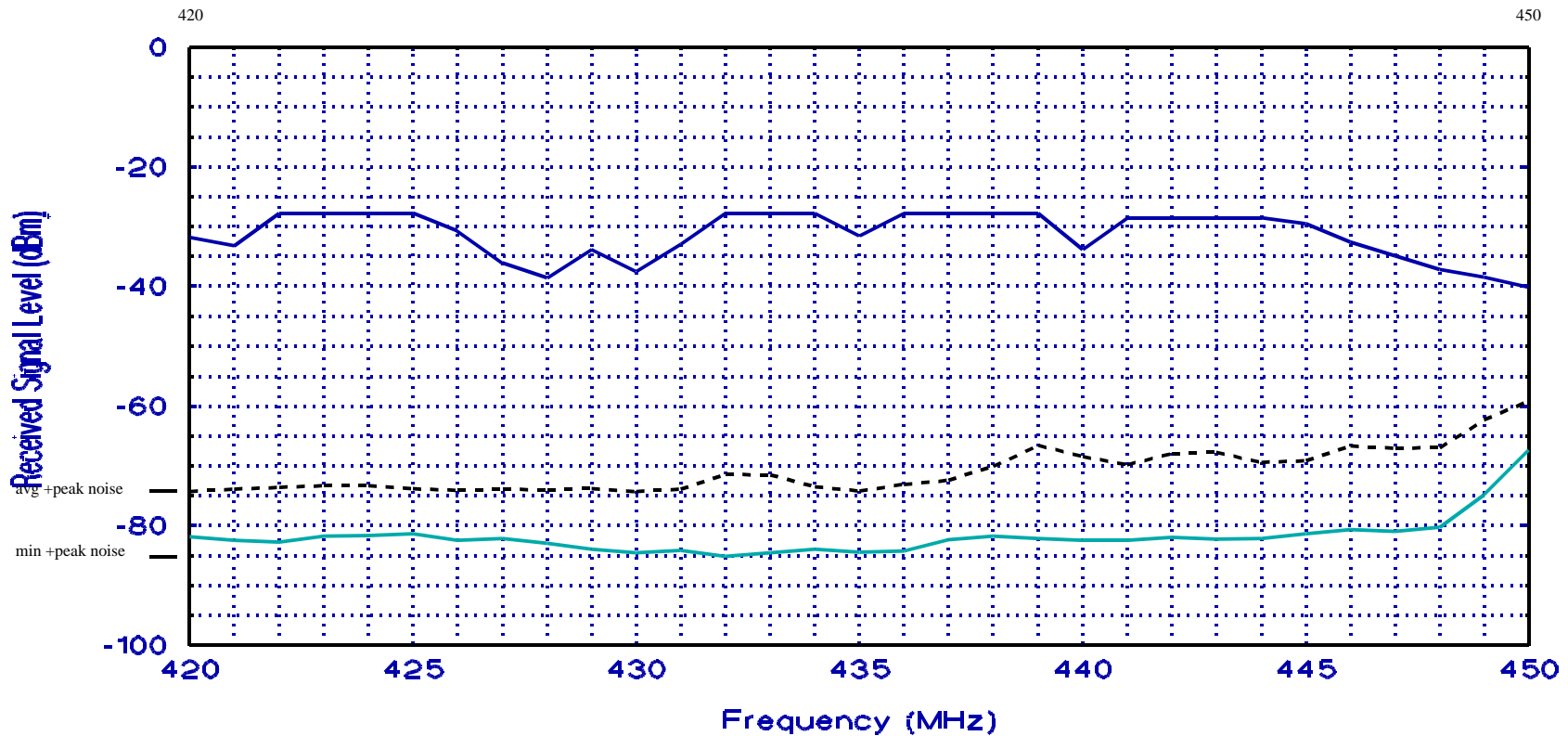

27

1. Radiolocation is limited to military services. Primarily, long-range radar systems essential to the nations early warning capability, law enforcement, and tracking objects in space. These systems use very high power and wide bandwidths. Low power radio control operations are permitted in the band. NASA and military use of telemetry and telecommand is also extensive.
2. There is some non-Government use of spread spectrum modes; also, amateur weak signal modes (432-433 MHz), television (420-432 & 438-444 MHz), repeaters (442-450 MHz), auxiliary links (433-435 MHz), and amateur satellite (435-438 MHz).

Figure 12. NTIA spectrum survey graph summarizing 68 scans across the 420-450 MHz range (System-1, band event 18, stepped algorithm, +peak detector, 1000-kHz bandwidth) at San Diego, CA, 1995.

GOVERNMENT ALLOCATIONS:			Meteorological-Satellite (space-to-Earth).	
NON-GOVERNMENT ALLOCATIONS:	LAND MOBILE.		LAND MOBILE.	
GENERAL UTILIZATION:	LMR, 1, 2, 3. (base or mobile)	LMR, 1, 2, 3. (mobile only)	LMR, 2, 4, 5. (base or mobile)	LMR, 2, 4, 5. (mobile only)
	450	455	460	465

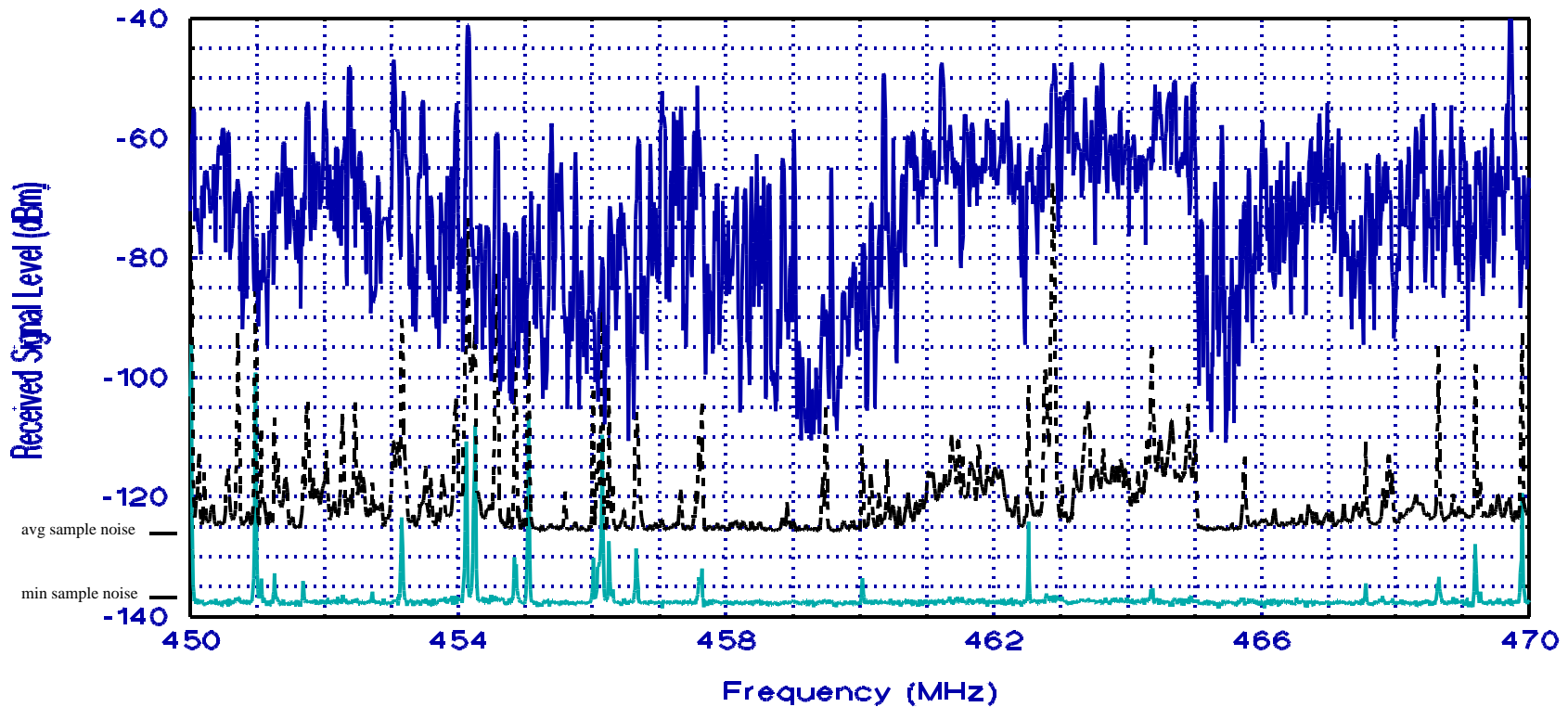

1. 450-451 MHz and 455-456 MHz: Remote pickup broadcast.
2. 451-454 MHz, 456-459 MHz, 460-462.5375 MHz, 462.7375-467.5375 MHz, and 467.7375-470 MHz: Public Safety, Industrial, Land Transportation.
3. 454-455 MHz and 459-460 MHz: Domestic Public.
4. 462.5375-462.7375 MHz and 467.5375-467.7375 MHz: Personal.
5. 460-470 MHz: GOES and TIROS satellite downlinks.

Figure 13. NTIA spectrum survey graph summarizing 20,400 sweeps across the 450-470 MHz range (System-1, band event 19, swept/m3 algorithm, sample detector, 10-kHz bandwidth) at San Diego, CA, 1995.

GOVERNMENT ALLOCATIONS:								
NON-GOVERNMENT ALLOCATIONS:	BROADCASTING, LAND MOBILE, 1, 2.							
GENERAL UTILIZATION:	Channel 14	Channel 15	Channel 16	Channel 17	Channel 18	Channel 19	Channel 20	
	470	476	482	488	494	500	506	512

29

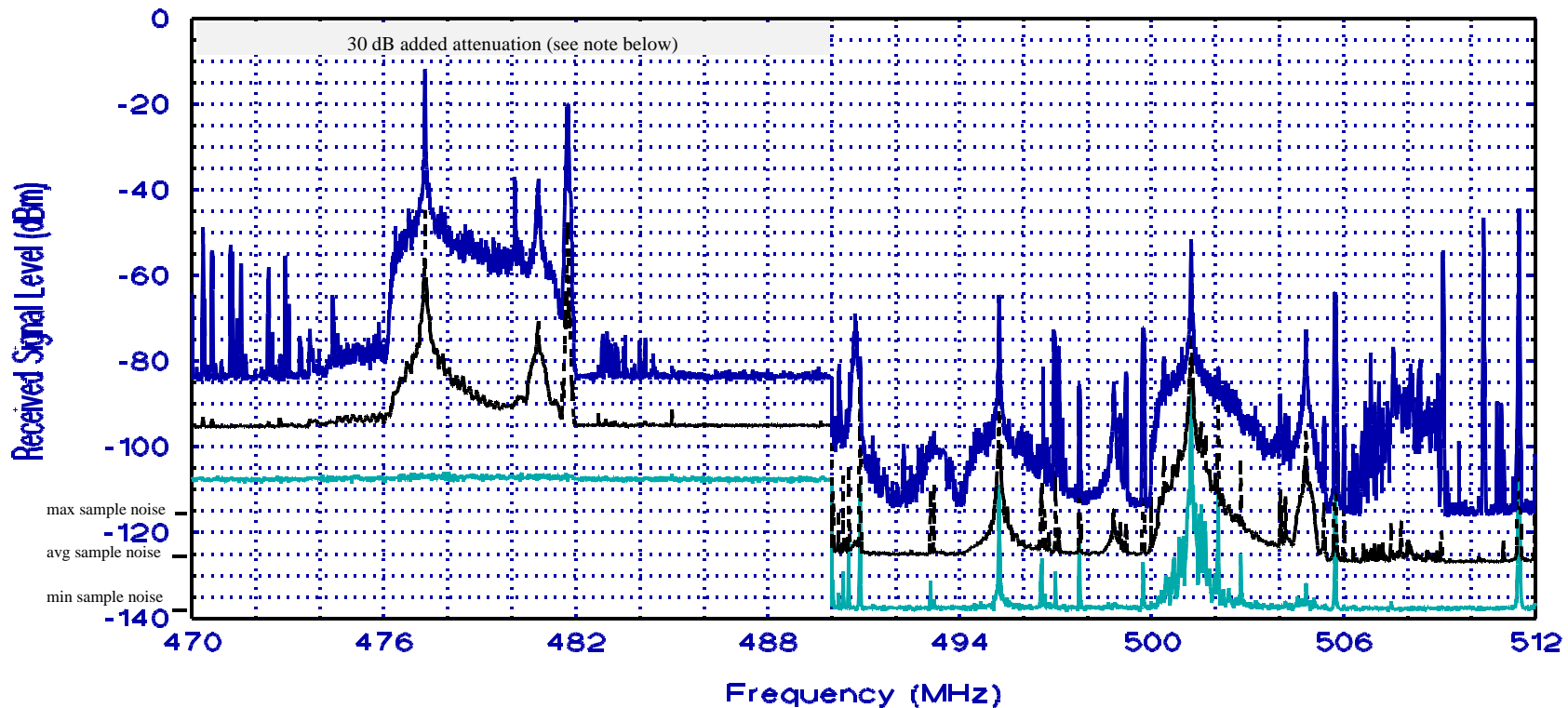

Note: Concerning 470-490 MHz attenuated data, see comments in Table 7 (Section 3.5.1).

2. The band is also allocated to the fixed service to permit subscription television operations.

1. Land Mobile Radio Services include Public Safety, Domestic Public, Industrial, and Land Transportation assignments in specific urban areas.

Figure 14. NTIA spectrum survey graph summarizing 9,600 sweeps across the 470-512 MHz range (System-1, band event 20, swept/m3 algorithm, sample detector, 10-kHz bandwidth) at San Diego, CA, 1995.

GOVERNMENT ALLOCATIONS:		1.		
NON-GOVERNMENT ALLOCATIONS:	BROADCASTING.	1.	BROADCASTING.	
GENERAL UTILIZATION:	Television broadcasting (channels 21-36).		Television broadcasting (channels 38-69).	

512

608-614

806

30

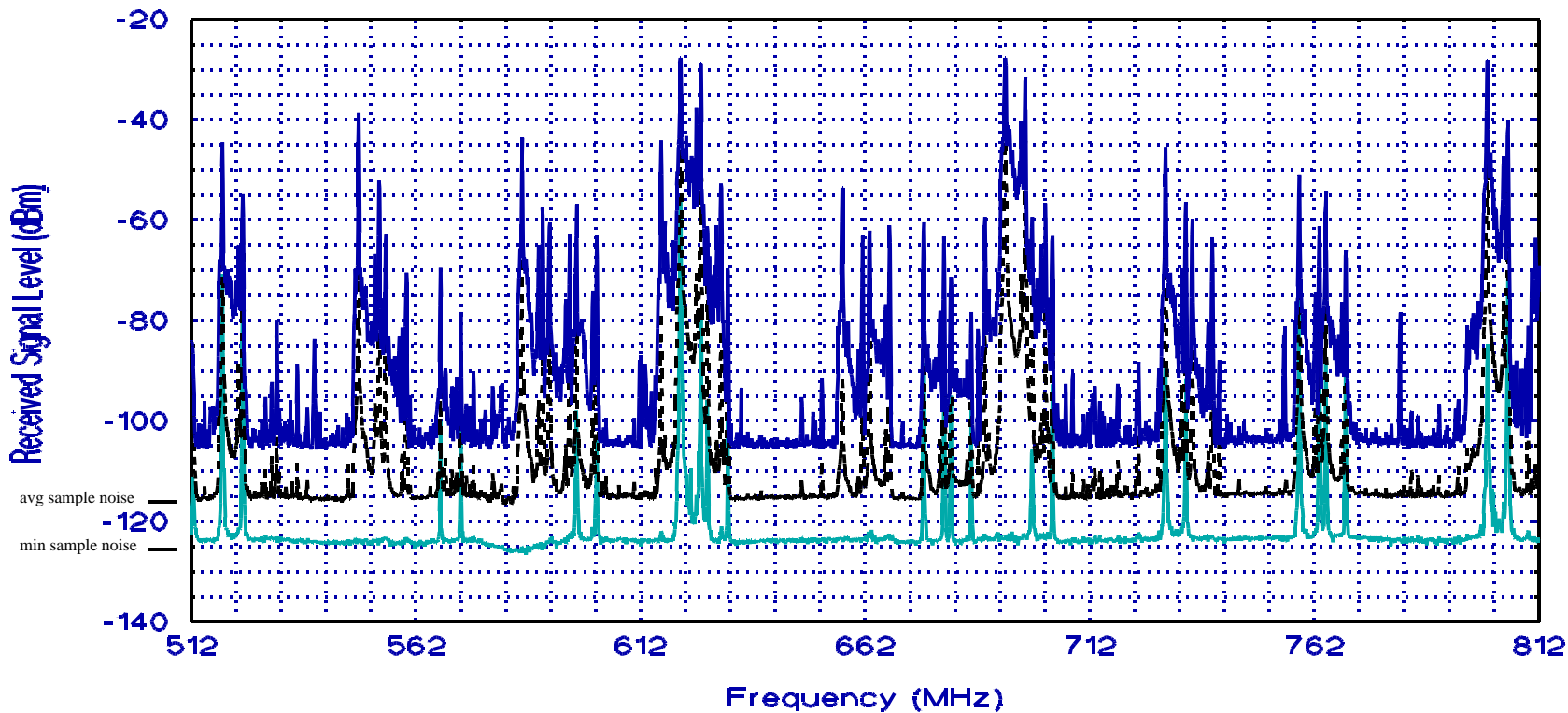

1. RADIO ASTRONOMY. No stations are authorized to transmit in this band.

Figure 15. NTIA spectrum survey graph summarizing 5,800 sweeps across the 512-806 MHz range (System-1, band event 21, swept/m3 algorithm, sample detector, 100-kHz bandwidth) at San Diego, CA, 1995.

GOVERNMENT ALLOCATIONS:									
NON-GOVERNMENT ALLOCATIONS:	LAND MOBILE, 1.								
GENERAL UTILIZATION:	Conventional and Trunked (mobile).	2.	Cellular Systems (Public Mobile).	4.	Conventional and Trunked (base).	3.	Cellular Systems (Public Base).	5.	6, 7.
	806	821	824	849-851	866	869	894	896	902

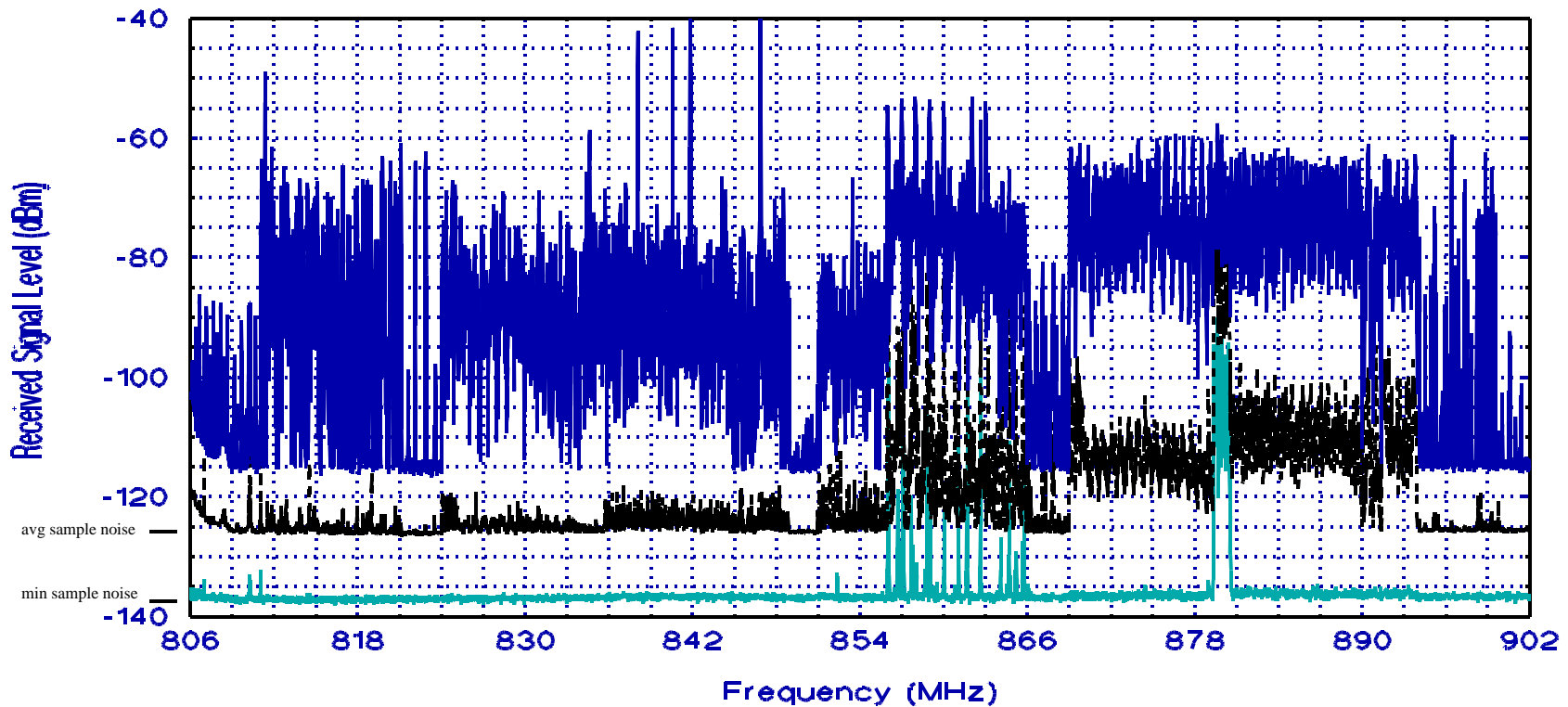

- | | |
|------------------------------------------------------------------------|----------------------------------------------------------------|
| 1. 806-890 MHz: Limited allocation is available for TV Channels 70-83. | 5. Aeronautical Mobile (air-to-ground). |
| 2. Public Safety (mobile). | 6. 896-901 MHz: Private Land Mobile (paired with 935-940 MHz). |
| 3. Public Safety (base). | 7. 901-902 MHz: General Mobile. |
| 4. Aeronautical Mobile (ground-to-air). | |

Figure 16. NTIA spectrum survey graph summarizing 4,020 sweeps across the 806-902 MHz range (System-1, band event 22, swept/m3 algorithm, sample detector, 10-kHz bandwidth) at San Diego, CA, 1995.

GOVERNMENT ALLOCATIONS:	RADIOLOCATION.	
NON-GOVERNMENT ALLOCATIONS:		
GENERAL UTILIZATION:	Military radiolocation systems, Industrial scientific and medical (ISM), Automatic Vehicle Monitoring (AVM), spread spectrum devices, microwave ovens, digital communications, repeaters, 1.	

902

928

32

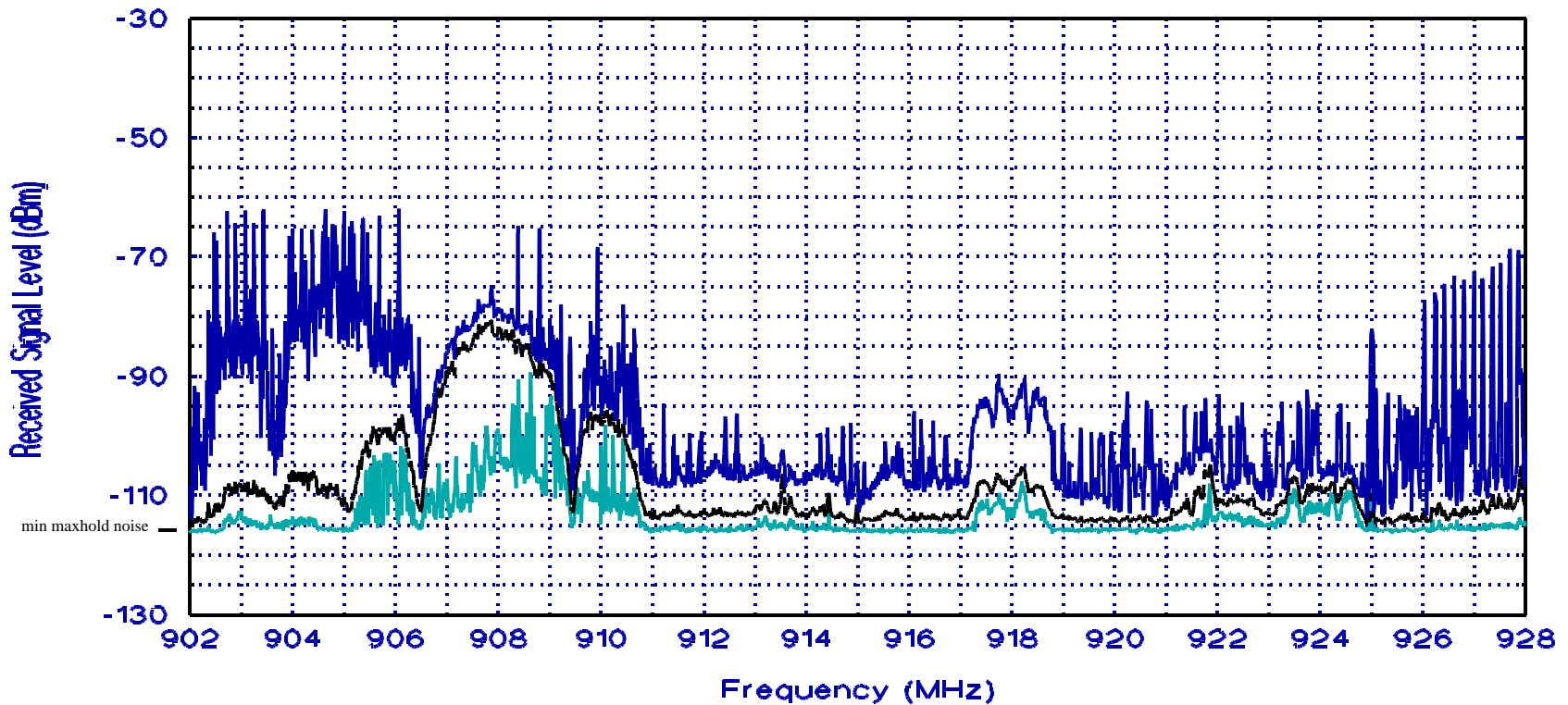

1. Fixed and mobile radio services are permitted on a secondary basis; however, band utilization is increasing for non-Government ISM, spread spectrum and other modes, amateur, etc., as permitted in Region 2.

Figure 17. NTIA spectrum survey graph summarizing 16,800 sweeps across the 902-928 MHz range (System-1, band event 23, swept algorithm, maximum-hold detector, 10-kHz bandwidth) at San Diego, CA, 1995.

GOVERNMENT ALLOCATIONS:	RADIOLOCATION.
NON-GOVERNMENT ALLOCATIONS:	
GENERAL UTILIZATION:	Military radiolocation systems, Industrial scientific and medical (ISM), Automatic Vehicle Monitoring (AVM), spread spectrum devices, microwave ovens, digital communications, repeaters, 1.

902

928

33

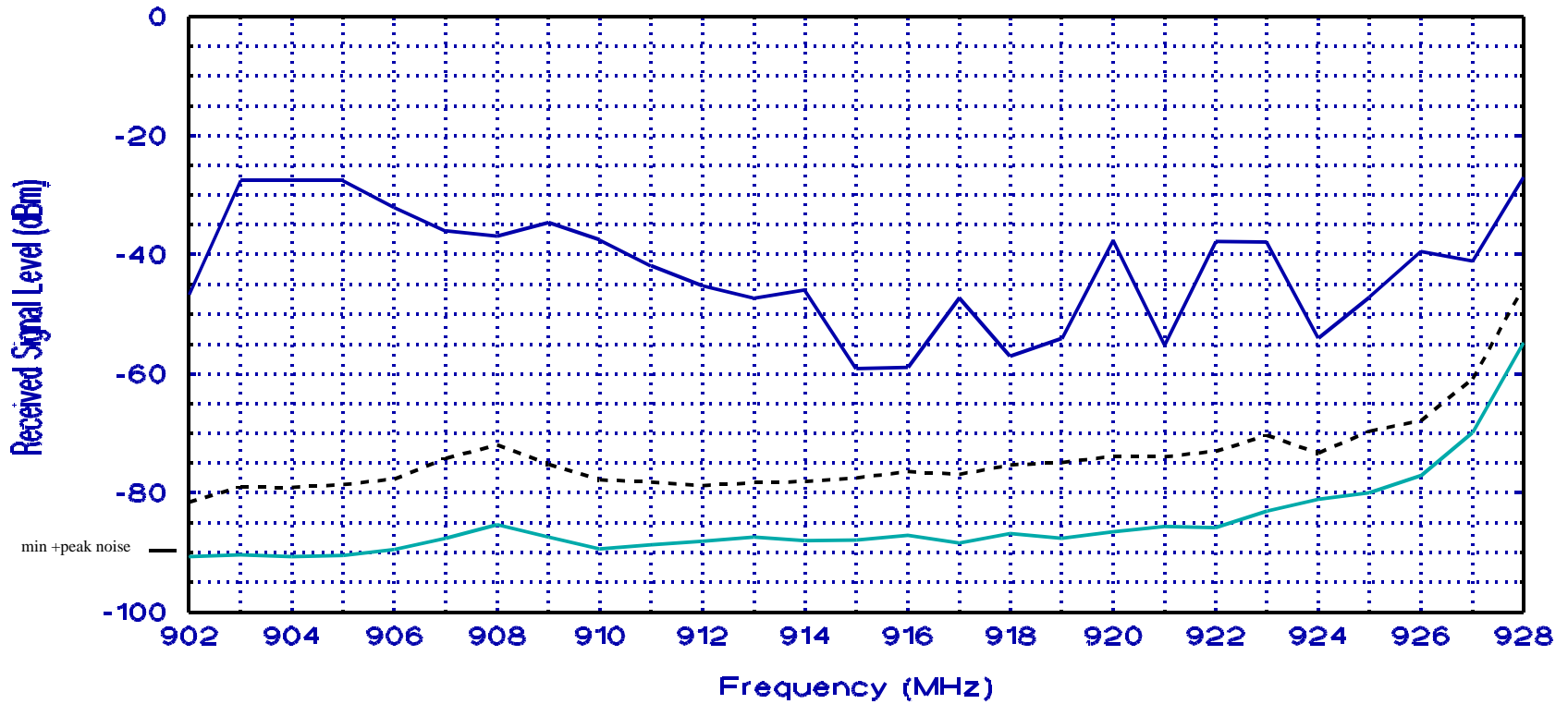

1. Fixed and mobile radio services are permitted on a secondary basis; however, band utilization is increasing for non-Government ISM, spread spectrum and other modes, amateur, etc., as permitted in Region 2.

Figure 18. NTIA spectrum survey graph summarizing 63 scans across the 902-928 MHz range (System-1, band event 24, stepped algorithm, +peak detector, 1000-kHz bandwidth) at San Diego, CA, 1995.

GOVERNMENT ALLOCATIONS:			FIXED.			FIXED.	
NON-GOVERNMENT ALLOCATIONS:	1.	LAND MOBILE	FIXED.	LAND MOBILE.	5.	FIXED.	FIXED.
GENERAL UTILIZATION:	1.	2.	3.	Private land mobile (base), 4.		3.	Auxiliary broadcasting, private fixed microwave, studio-to-transmitter links (STL's), 6.
	928	929	932	935	940	941	944
							960

34

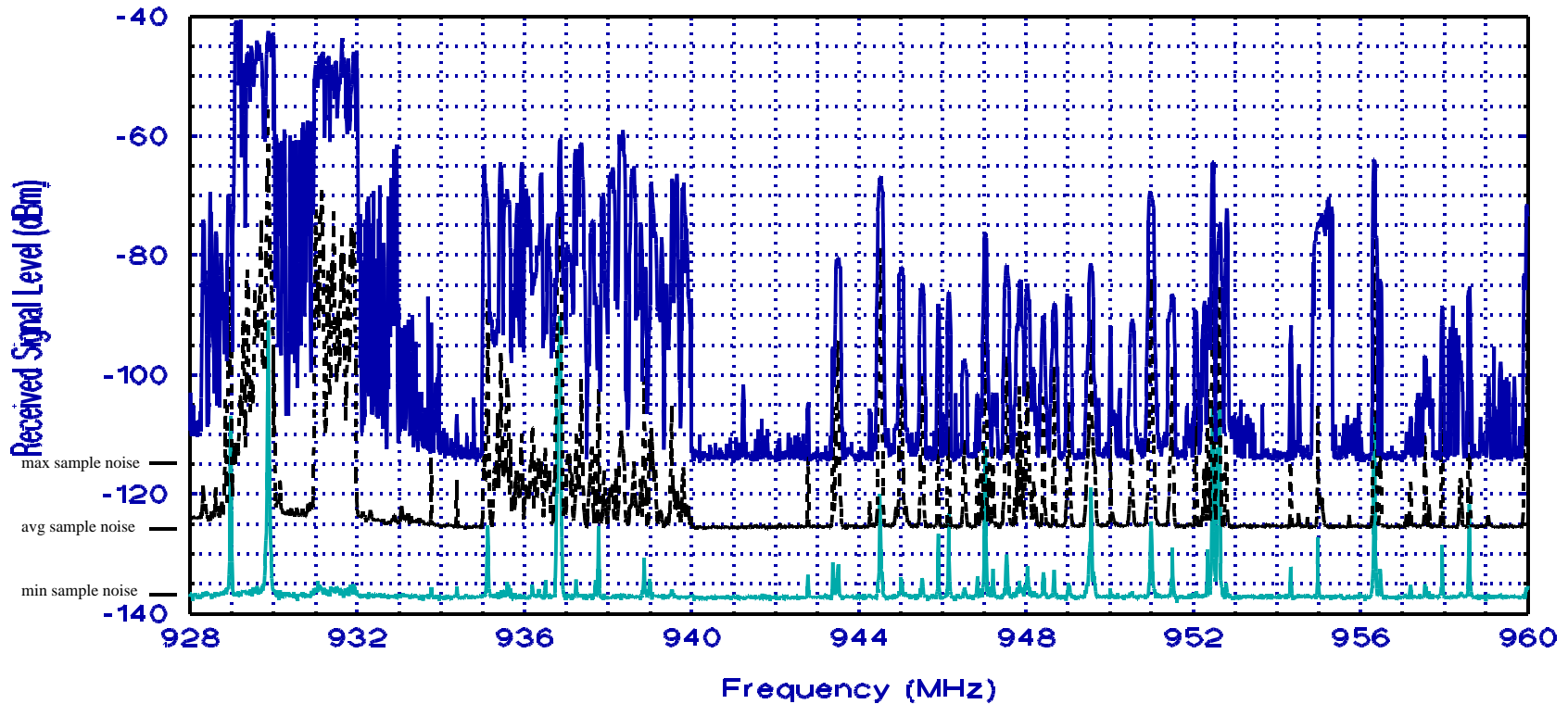

- | | |
|-----------------------------------------------------------------------------------------------------------------------------------------------------------------------------------------------------------------------------------------------------------------------------------------------------------------------|-------------------------------------------------------------------------------------------------------------------------------------------------------------------------------------------------------------------------------------------------------------------------------------------------------|
| <ol style="list-style-type: none"> 1. FIXED. Private fixed microwave, public and private land mobile, telemetry applications. Two-way services paired with 952-953 MHz. 2. Public and private land mobile. 3. Paired band for point-to-point and point-to-multipoint communications. | <ol style="list-style-type: none"> 4. Trunked and conventional systems in 12.5 kHz channels (paired with 896-901 MHz). 5. MOBILE. 6. 944-952 MHz: Primarily STL's. 952-953 MHz paired with 928-929 MHz. 953-960 MHz: Primarily, fixed point-to-point communications. |
|-----------------------------------------------------------------------------------------------------------------------------------------------------------------------------------------------------------------------------------------------------------------------------------------------------------------------|-------------------------------------------------------------------------------------------------------------------------------------------------------------------------------------------------------------------------------------------------------------------------------------------------------|

Figure 19. NTIA spectrum survey graph summarizing 27,600 sweeps across the 928-960 MHz range (System-1, band event 25, swept/m3 algorithm, sample detector, 10-kHz bandwidth) at San Diego, CA, 1995.

GOVERNMENT	AERONAUTICAL RADIONAVIGATION, 1.	
ALLOCATIONS:		
NON-GOVERNMENT ALLOCATIONS:	AERONAUTICAL RADIONAVIGATION, 1.	
GENERAL UTILIZATION:	TACAN, DME, MLS, ATCRBS, MODE-S, T-CAS, JTIDS, 2.	

960

1215

35

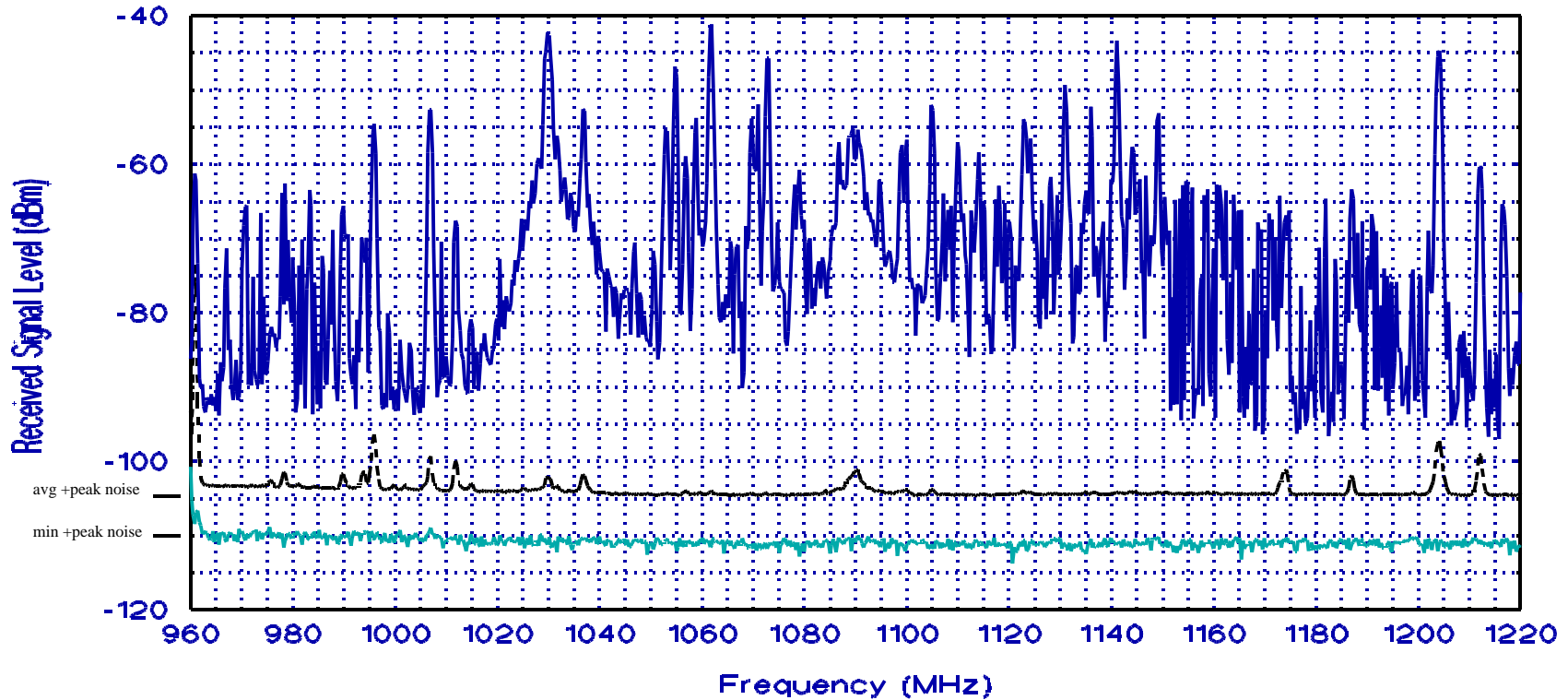

1. The 960-1215 MHz band is reserved on a worldwide basis for the use and development of electronic aids to air navigation. On a case by case basis, Government systems utilizing spread spectrum techniques for terrestrial communication, navigation and identification may be authorized on condition that aeronautical radionavigation services not experience harmful interference.

2. Tactical Air Navigation (TACAN). Distance Metering Equipment (DME). Microwave Landing System (MLS). Air Traffic Control Radar Beacon system (ATCRBS, MODE-S, and IFF). Collision Avoidance System (T-CAS). Joint Tactical Information Distribution System (JTIDS).

Figure 20. NTIA spectrum survey graph summarizing 36,500 sweeps across the 960-1215 MHz range (System-2, band event 05, swept/m3 algorithm, +peak detector, 300-kHz bandwidth) at San Diego, CA, 1995.

GOVERNMENT ALLOCATIONS:	RADIOLOCATION, 1.	RADIOLOCATION.	AERONAUTICAL RADIONAVIGATION, Radiolocation.	FIXED, MOBILE, RADIOLOCATION.	
NON-GOVERNMENT ALLOCATIONS:		Amateur.	AERONAUTICAL RADIONAVIGATION.		
GENERAL UTILIZATION:	2, 3, 4.	3, 4, 5.	3, 4.	3, 6, Fixed and Mobile links.	
	1215	1240	1300	1350	1400

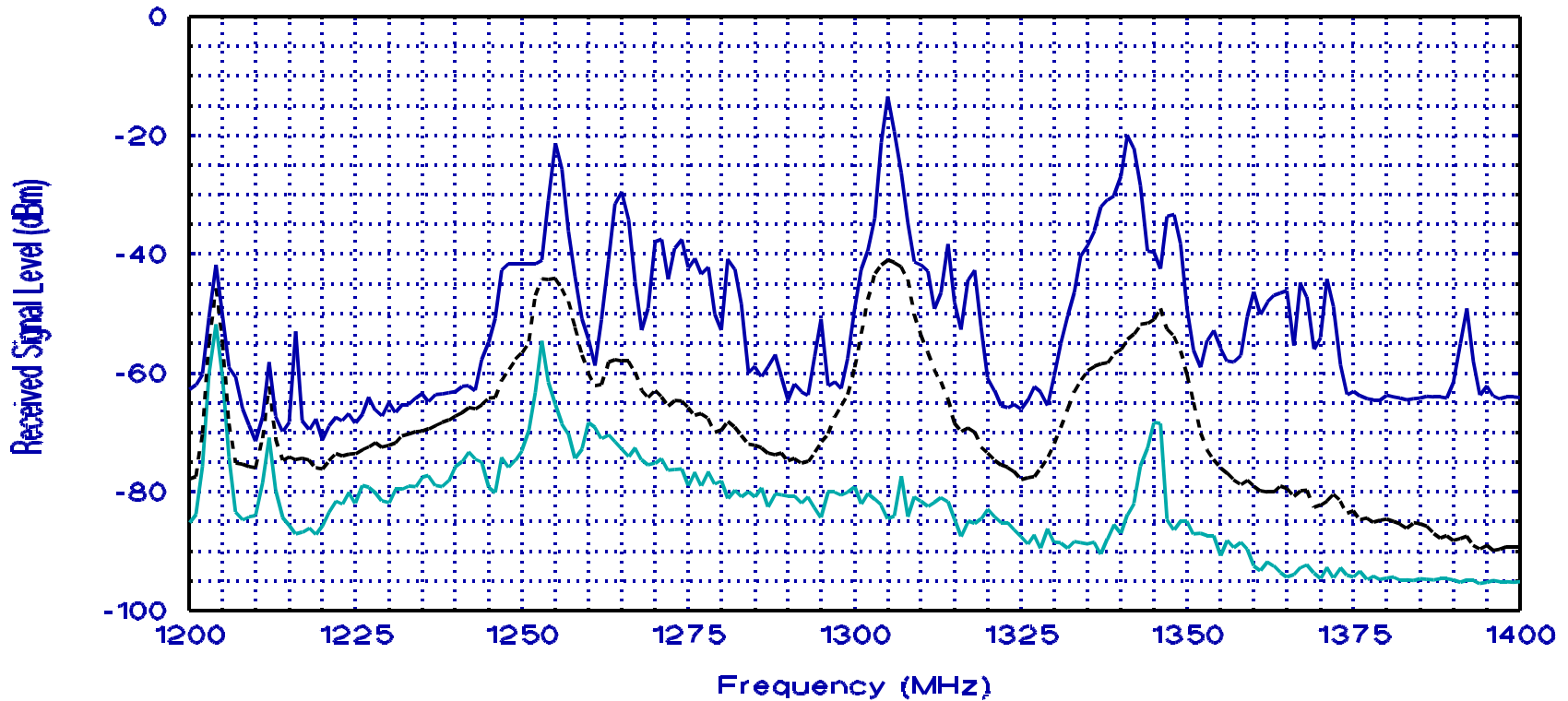

- | | |
|-------------------------------------------------------------------------------------------------|-------------------------------------------------------------------------------------------------------|
| 1. RADIONAVIGATION-SATELLITE (space-to-Earth). | 4. Tethered balloon mounted radar for drug interdiction. |
| 2. 1227.6 MHz: Global Positioning System (GPS). | 5. Amateur television. Amateur weak signal modes and other modes. Amateur satellite (Earth-to-space). |
| 3. High-power long-range surveillance radars including FAA Air-Route Surveillance Radar (ARSR). | 6. 1381.05 MHz: GPS data relay. |

Figure 21. NTIA spectrum survey graph summarizing 28 scans across the 1215-1400 MHz range (System-2, band event 06, stepped algorithm, +peak detector, 1000-kHz bandwidth) at San Diego, CA, 1995.

GOVERNMENT ALLOCATIONS:	FIXED, MOBILE, RADIOLOCATION, 1.
NON-GOVERNMENT ALLOCATIONS:	1.
GENERAL UTILIZATION:	Military radiolocation, fixed and mobile links, GPS, aeronautical radionavigation, 2, 3.

1350

1400

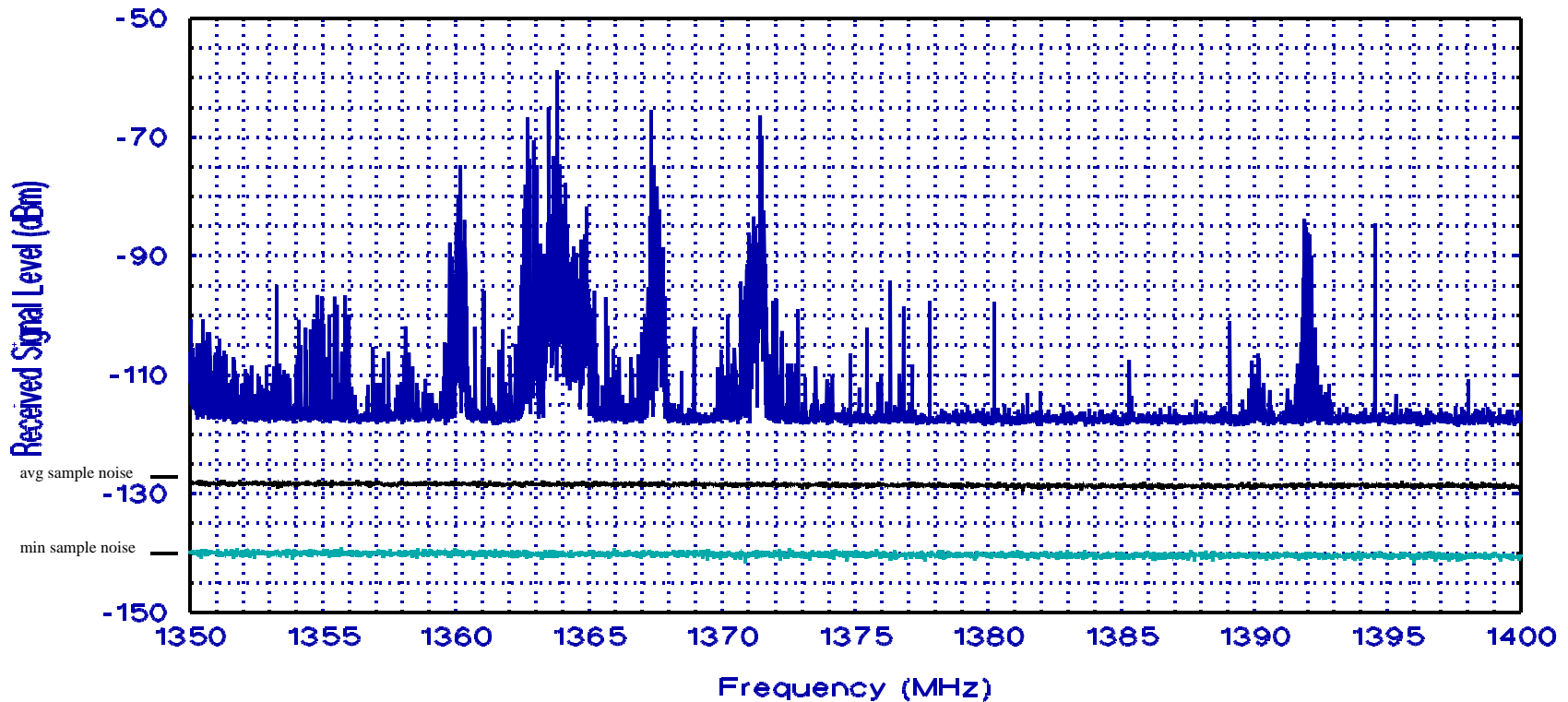

37

1. 1350-1370 MHz: AERONAUTICAL RADIONAVIGATION (allocation for U.S. and Canada only).
2. Military radiolocation applications are primarily high-power long-range surveillance radars.
3. 1369.05-1393.05 MHz: Fixed and mobile satellite services (space-to-Earth) for the relay of nuclear burst data. GPS operates at 1381.05 MHz to relay data detected by orbiting satellites.

Figure 22. NTIA spectrum survey graph summarizing 4,900 sweeps across the 1350-1400 MHz range (System-2, band event 07, swept/m3 algorithm, sample detector, 10-kHz bandwidth) at San Diego, CA, 1995.

GOVERNMENT ALLOCATIONS:	RADIO ASTRONOMY, 1.	2.	3.	MOBILE (Aeronautical telemetry).	
NON-GOVERNMENT ALLOCATIONS:	RADIO ASTRONOMY, 1.	4.	5.	MOBILE (Aeronautical telemetry).	
GENERAL UTILIZATION:	Passive.			Aeronautical telemetry and telecommand.	

1400

1427-1429 1435

1530

38

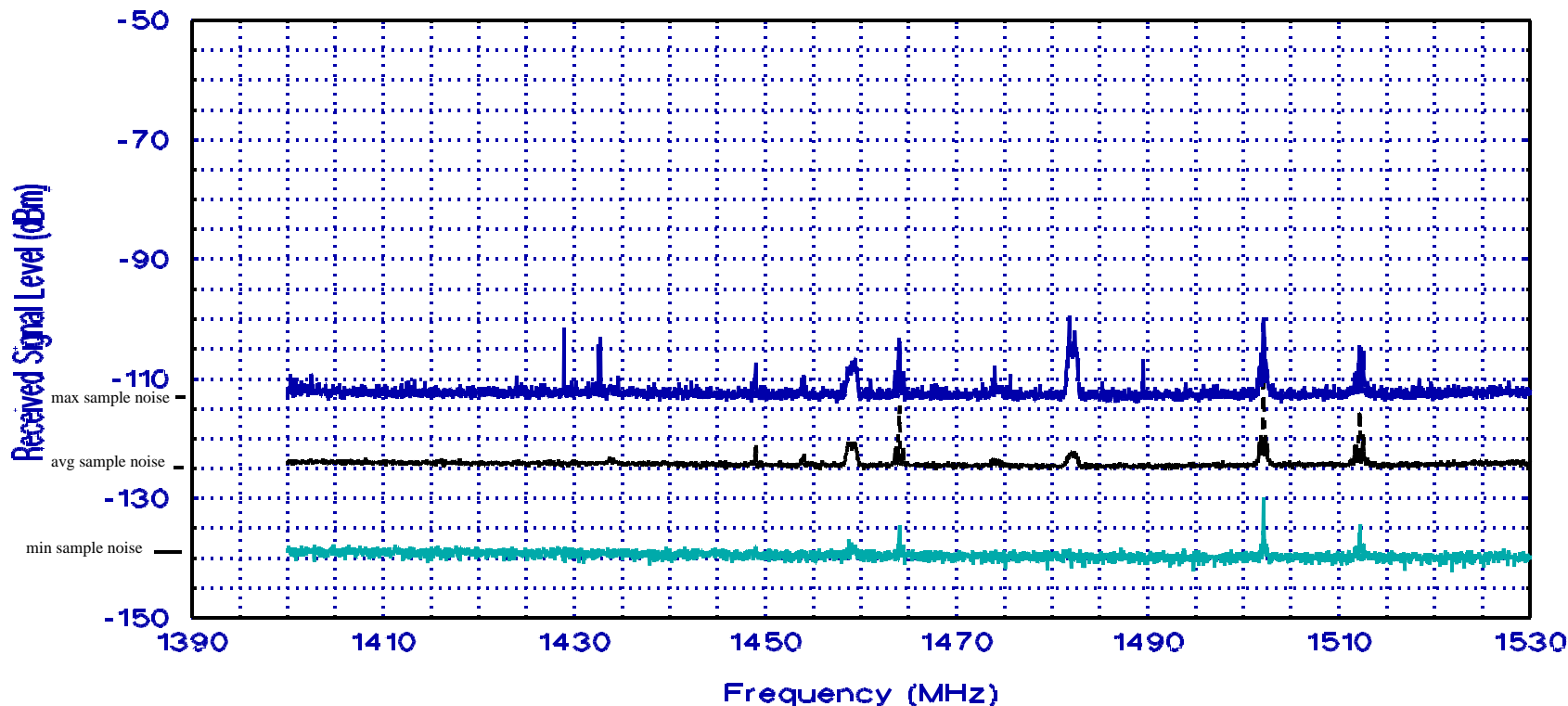

- | | |
|--------------------------------------------------------------------------------|--------------------------------------------------------------------------------------------------|
| 1. EARTH EXPLORATION-SATELLITE (Passive), SPACE RESEARCH (Passive). | 4. SPACE OPERATION (Earth-to-space), Land Mobile (Telemetry and telecommand), Fixed (Telemetry). |
| 2. FIXED, MOBILE except aeronautical mobile, SPACE OPERATION (Earth-to-space). | 5. Land Mobile (Telemetry and telecommand), Fixed (telemetry). |
| 3. FIXED, MOBILE. | |

Figure 23. NTIA spectrum survey graph summarizing 9,600 sweeps across the 1400-1530 MHz range (System-2, band event 08, swept/m3 algorithm, sample detector, 30-kHz bandwidth) at San Diego, CA, 1995.

GOVERNMENT ALLOCATIONS:	1.	2.	AERONAUTICAL RADIONAVIGATION, RADIONAVIGATION-SATELLITE (space-to-Earth, 1559-1610 MHz).	3.	4.	5.	METEOROLOGICAL AIDS, (Radiosonde), 6.	FIXED, 7.	
NON-GOVERNMENT ALLOCATIONS:	1.	2.	AERONAUTICAL RADIONAVIGATION, RADIONAVIGATION-SATELLITE (space-to-Earth, 1559-1610 MHz).	3.	4.	5.	METEOROLOGICAL AIDS, (Radiosonde), 6.	7, Fixed	
GENERAL UTILIZATION:	INMARSAT, SARSAT.	AMS(R)S.	1559-1610 MHz: GPS, GLONASS. 1610-1626.5 MHz: Airborne aids to air navigation, only.	INMARSAT.	AMS(R)S.		Radiosondes and satellite imagery.	8.	

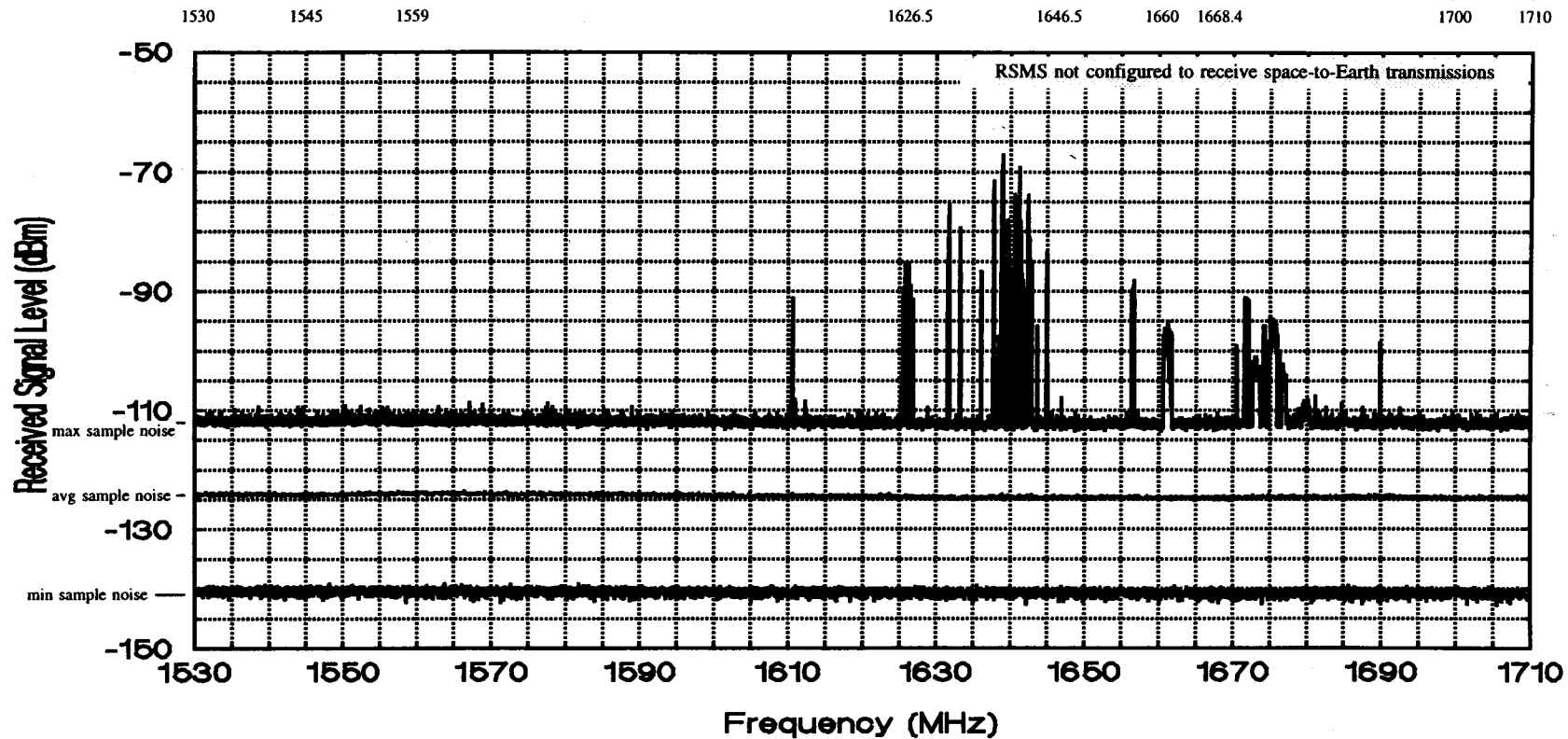

- 1530-1544 MHz: MARITIME MOBILE-SATELLITE (space-to-Earth). 1530-1535 MHz: Mobile (Aeronautical telemetry). 1544-1545 MHz: MOBILE-SATELLITE (space-to-Earth).
- AERONAUTICAL MOBILE-SATELLITE (space-to-Earth). 1545-1549.5 MHz: Mobile-Satellite (space-to-Earth). 1549.5-1558.5 MHz: MOBILE-SATELLITE (space-to-Earth).
- 1626.5-1645.5 MHz: MARITIME MOBILE-SATELLITE (Earth-to-space). 1645.5-1646.5 MHz: MOBILE-SATELLITE (Earth-to-space, distress and safety only).
- AERONAUTICAL MOBILE-SATELLITE (Earth-to-space). 1646.5-1651 MHz: Mobile-Satellite (Earth-to-space). 1651-1660 MHz: MOBILE-SATELLITE (Earth-to-space).
- RADIO ASTRONOMY. 1660-1660.5 MHz: AERONAUTICAL MOBILE-SATELLITE (Earth-to space). 1660.5-1668.4 MHz: SPACE RESEARCH (Passive).
- 1668.4-1670 MHz: RADIO ASTRONOMY. 1670-1700 MHz: METEOROLOGICAL-SATELLITE (space-to-Earth).
- METEOROLOGICAL-SATELLITE (space-to-Earth).
- GOES, TIROS-N.

Figure 24. NTIA spectrum survey graph summarizing 35,000 sweeps across the 1530-1710 MHz range (System-2, band event 09, swept/m3 algorithm, sample detector, 30-kHz bandwidth) at San Diego, CA, 1995.

GOVERNMENT ALLOCATIONS:	FIXED, MOBILE.			FIXED (LOS only), MOBILE (LOS only), 3.	5.
NON-GOVERNMENT ALLOCATIONS:		FIXED.	MOBILE, Fixed.		6.
GENERAL UTILIZATION:	LOS fixed links, telemetry, telecommand, 1.	Private fixed microwave. Future PCS.	Auxiliary broadcasting, domestic public fixed, cable TV, control and repeater links, point to multipoint video, cellular, 2.	TDRSS, SGLS, 4.	7.
	1710	1850	1990	2200	2290-2300

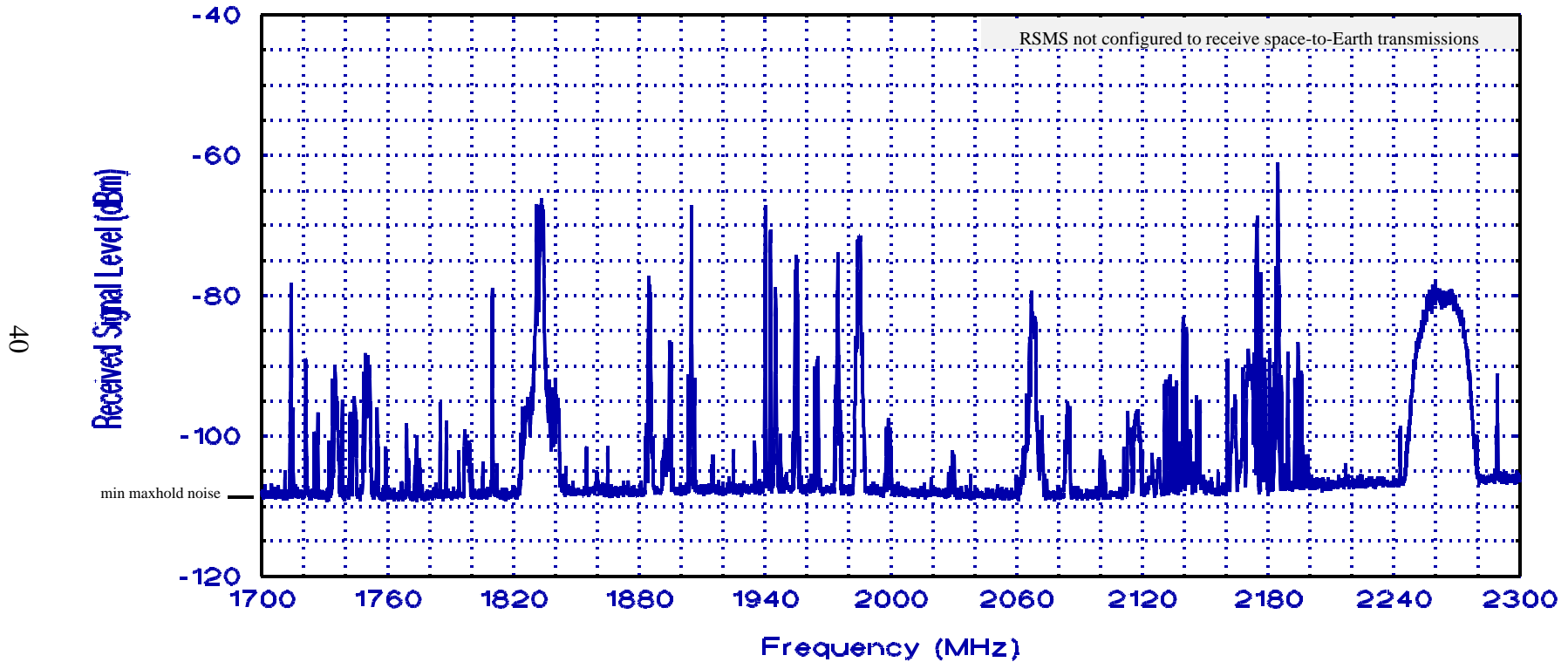

1. Predominantly federal medium-capacity line of sight (LOS) fixed service band.
2. 1990-2110 MHz: Electronic news gathering (ENG). GOES uplink, NASA's global ground network and TDRSS (2025-2110 MHz). 2110-2200 MHz: NASA space and Earth to space command links support Pioneers, Voyagers, MAGELLAN, GALILEO, and ULYSSES (2110-2120 MHz). Paired fixed links (2110-2130 MHz with 2160-2180 MHz; 2130-2150 MHz with 2180-2200 MHz). Point-to-point and point to multipoint links (2150-2160 MHz).
3. SPACE RESEARCH (space-to-Earth) (space-to-space), SPACE OPERATION (space-to-Earth) (Earth-to-space), EARTH EXPLORATION-SATELLITE space-to-Earth(space-to-space).
4. Space telemetry, telecommand and control systems. Fixed microwave.
5. FIXED, MOBILE except aeronautical mobile, SPACE RESEARCH (space-to-Earth) (Deep Space only).
6. SPACE RESEARCH (space-to-Earth) (Deep Space only).
7. NASA deep space network space-to-Earth telemetry. Radio astronomy observations.

Figure 25. NTIA spectrum survey azimuth-scan graph of the 1710-2300 MHz range (System-2, band event 10, swept algorithm, maximum-hold detector, 100-kHz bandwidth) at San Diego, CA, 1995.

GOVERNMENT ALLOCATIONS:	1.	RADIOLOCATION, MOBILE, Fixed.	RADIOLOCATION, 5.				
NON-GOVERNMENT ALLOCATIONS:	2.	MOBILE.	6.	Amateur.	FIXED, MOBILE, Radiolocation.	8.	
GENERAL UTILIZATION:	3.	Telemetry, telemetry communications, aeronautical telemetry, 4.		Amateur Satellite (space-to-Earth). Amateur mixed modes, 7.	7.	7, 9.	

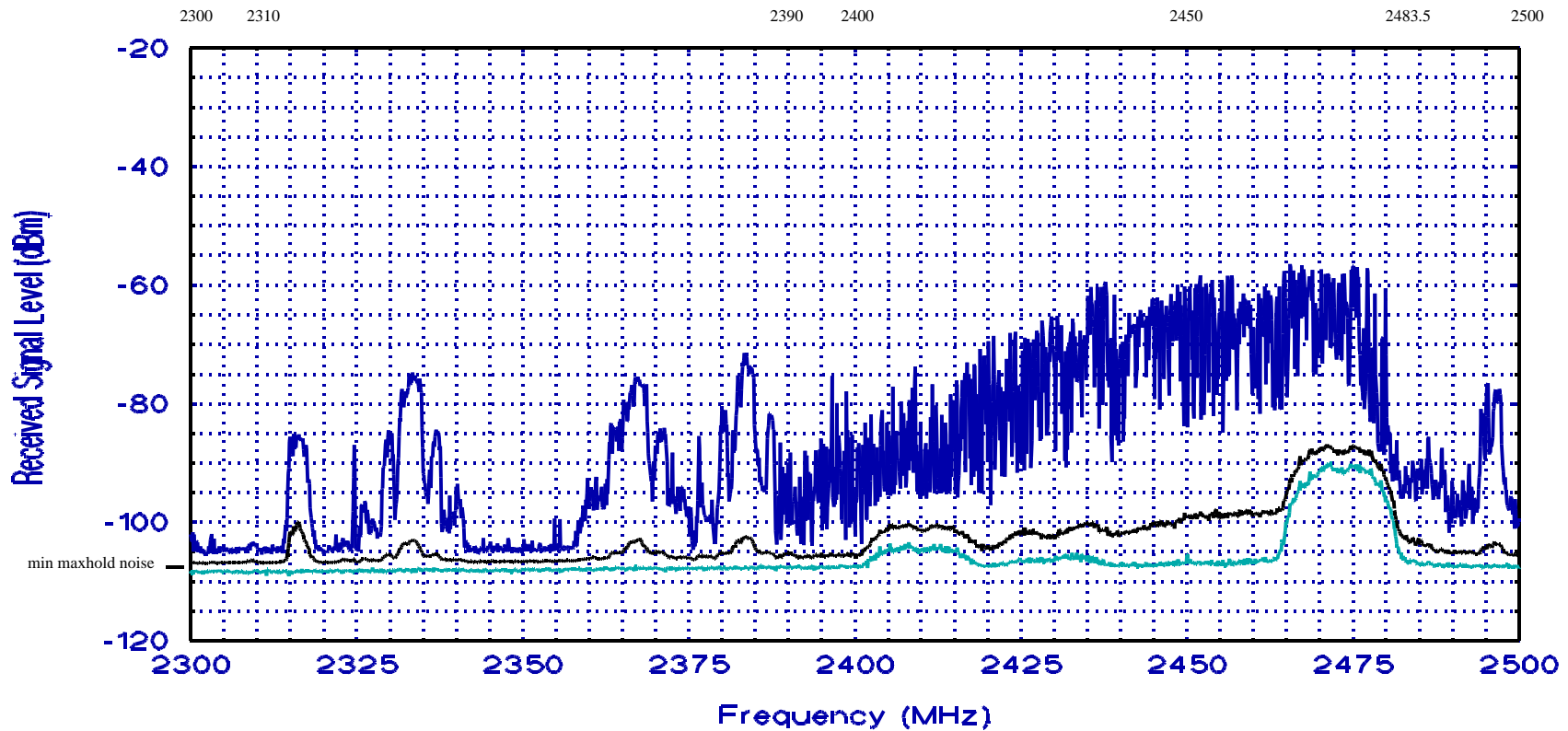

- | | |
|----------------------------------------------------------------------------------------------------------------------------------|--------------------------------------------------------------------------------------------------------------------|
| 1. RADIOLOCATION, Fixed, Mobile. | 6. AMATEUR. |
| 2. Amateur. | 7. 2400-2500 MHz: Is also used for industrial scientific and medical (ISM) applications including microwave ovens. |
| 3. Amateur weak signal modes and other modes. | 8. RADIODETERMINATION-SATELLITE (space-to-Earth). |
| 4. AF High-power long-range surveillance radar and air traffic control radar. Venus Radar Mapper (VRM) synthetic aperture radar. | 9. Satellite downlinks and multichannel fixed and portable video transmission by TV broadcasters. |
| 5. No Government allocations in this band after August 1995. | |

Figure 26. NTIA spectrum survey graph summarizing 28,800 sweeps across the 2300-2500 MHz range (System-2, band event 11, swept algorithm, maximum-hold detector, 100-kHz bandwidth) at San Diego, CA, 1995.

GOVERNMENT ALLOCATIONS:		3.	4.	
NON-GOVERNMENT ALLOCATIONS:	BROADCASTING-SATELLITE, FIXED, 1.	FIXED, BROADCASTING-SATELLITE, 1, 3.	4.	
GENERAL UTILIZATION:	Auxiliary broadcasting, pay television distribution, private video teleconferences, educational television (ITSF), 2.	Private fixed microwave, 2.		

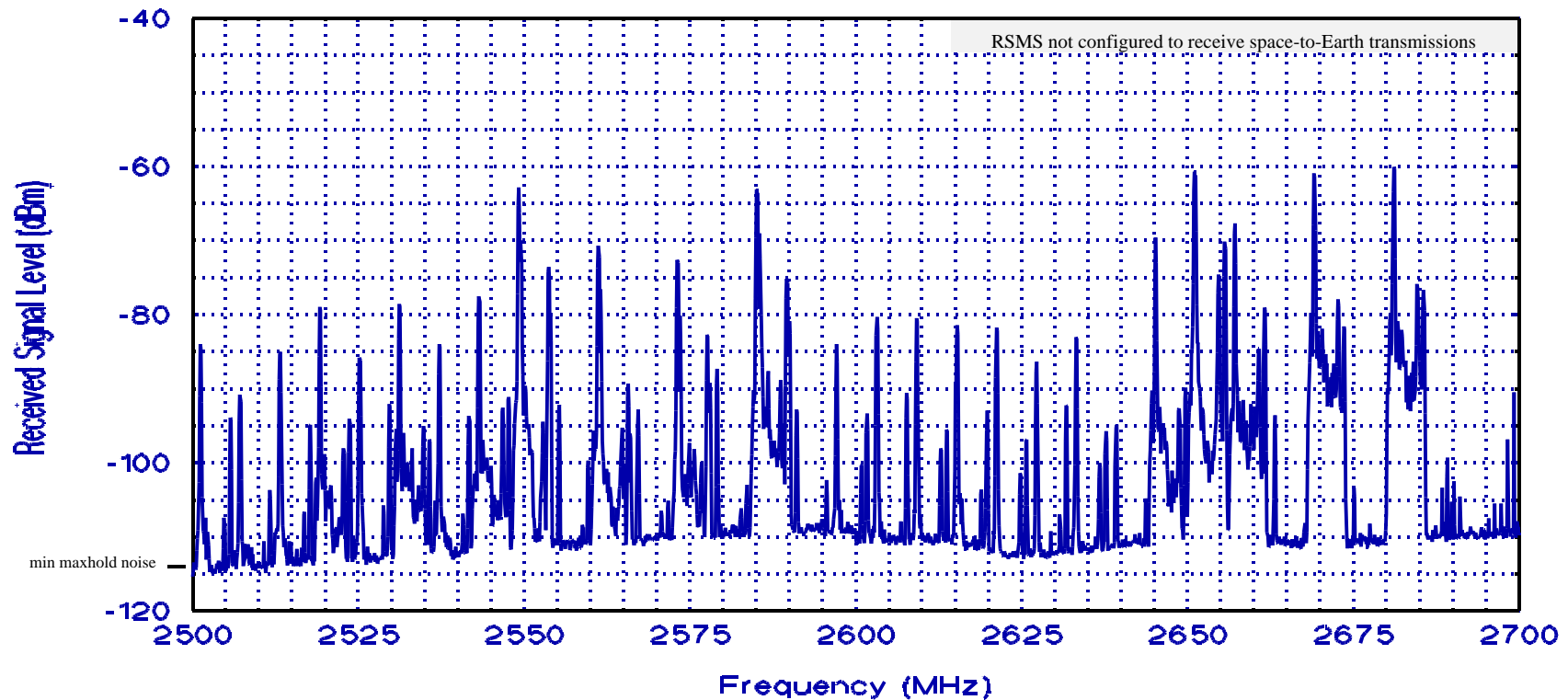

1. Broadcasting-satellite service is limited to community reception of educational and public service television programming.
2. 2500-2686 MHz: Omnidirectional transmission of multipoint MDS that can be contained within 6 MHz channel bandwidths.
3. Earth Exploration-Satellite (Passive), Radio Astronomy, Space Research (Passive).
4. EARTH EXPLORATION-SATELLITE (Passive), RADIO ASTRONOMY, SPACE RESEARCH (Passive).

Figure 27. NTIA spectrum survey azimuth-scan graph of the 2500-2700 MHz range (System-2, band event 12, swept algorithm, maximum-hold detector, 10-kHz bandwidth) at San Diego, CA, 1995.

GOVERNMENT ALLOCATIONS:	AERONAUTICAL RADIONAVIGATION, METEOROLOGICAL AIDS, Radiolocation, 1, 2.
NON-GOVERNMENT ALLOCATIONS:	
GENERAL UTILIZATION:	Airport surveillance radars (ASRs), military ground control approach radars (GCAs), NWS weather radars (NEXRAD, etc.), long-range surveillance radars and air traffic control radars.

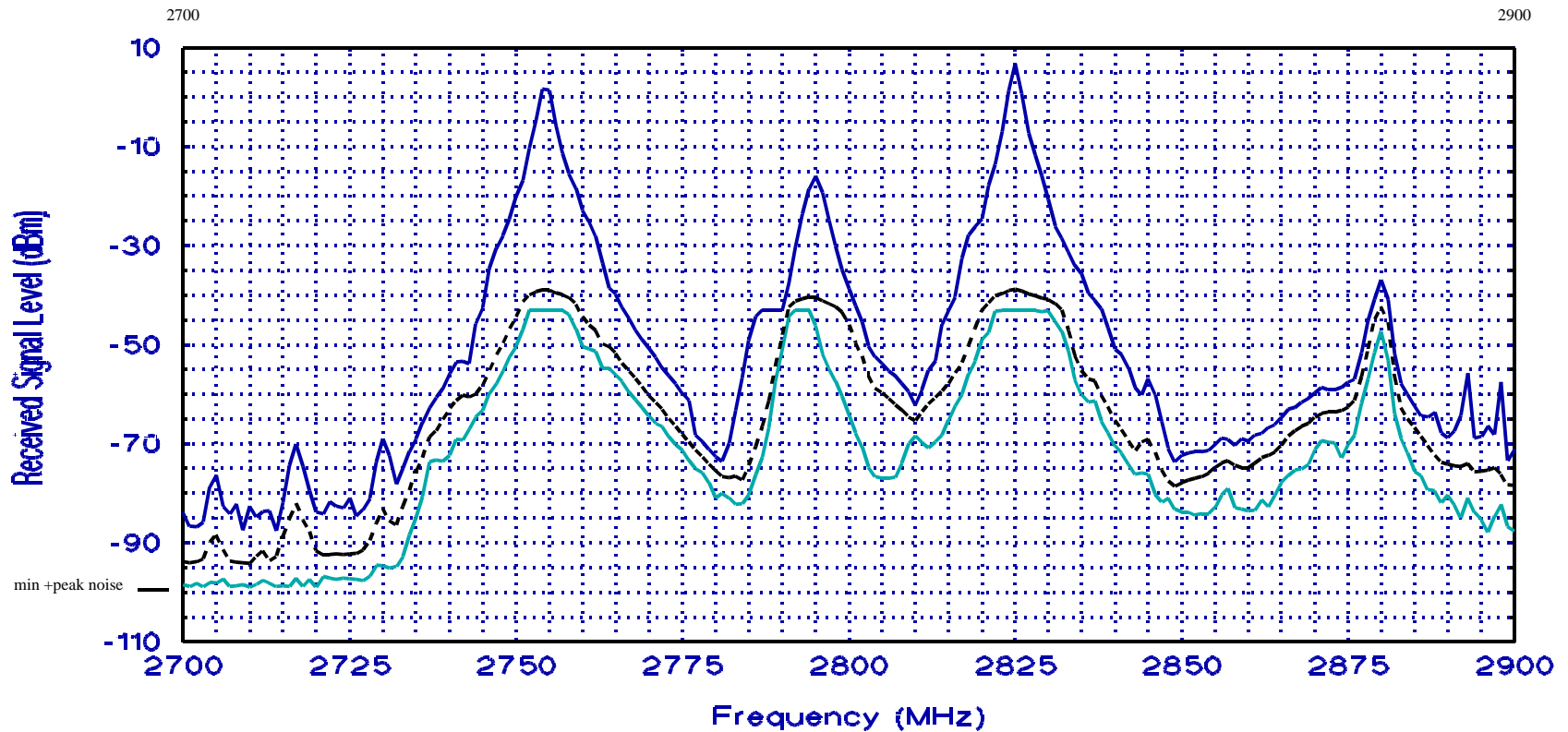

1. The aeronautical radionavigation service is restricted to ground-based radars and associated airborne transponders that transmit only in this band when actuated by these radars.
2. The secondary radiolocation service is limited to the military and must be fully coordinated with the primary services.

Figure 28. NTIA spectrum survey graph summarizing 28 scans across the 2700-2900 MHz range (System-2, band event 13, stepped algorithm, +peak detector, 1000-kHz bandwidth) at San Diego, CA, 1995.

GOVERNMENT ALLOCATIONS:	MARITIME RADIONAVIGATION, Radiolocation, 1, 2.
NON-GOVERNMENT ALLOCATIONS:	MARITIME RADIONAVIGATION, Radiolocation, 1, 2.
GENERAL UTILIZATION:	Maritime radars and radar beacons (racons), military high-power 3-D long-range surveillance radars and air traffic control radars.

2900

3100

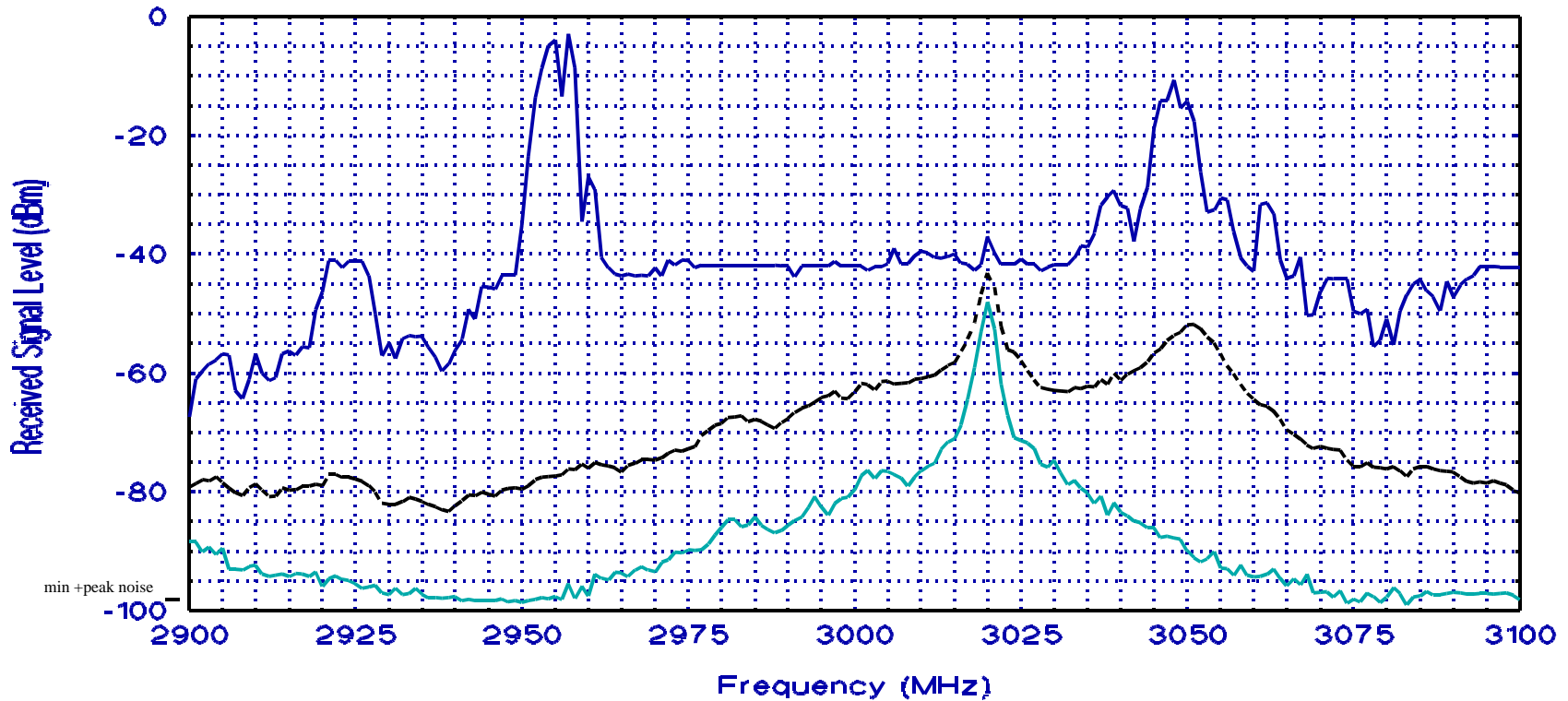

44

1. Radiolocation assignments are primarily for the military; however, other agency use is permitted for experimentation, research, and survey operations, if no harmful interference occurs.

2. 2900-3000 MHz: Also, allocated for next generation weather radar (NEXRAD) systems.

Figure 29. NTIA spectrum survey graph summarizing 48 scans across the 2900-3100 MHz range (System-2, band event 14, stepped algorithm, +peak detector, 1000-kHz bandwidth) at San Diego, CA, 1995.

GOVERNMENT ALLOCATIONS:	RADIOLOCATION.	RADIOLOCATION.	RADIOLOCATION, 1.	RADIOLOCATION, 1.	
NON-GOVERNMENT ALLOCATIONS:	Radiolocation.	Amateur, Radiolocation.	Radiolocation.	FIXED-SATELLITE (space-to-Earth), 2.	
GENERAL UTILIZATION:	3.	3.	3.	INMARSAT, INTELSAT.	
	3100	3300	3500	3600	3700

45

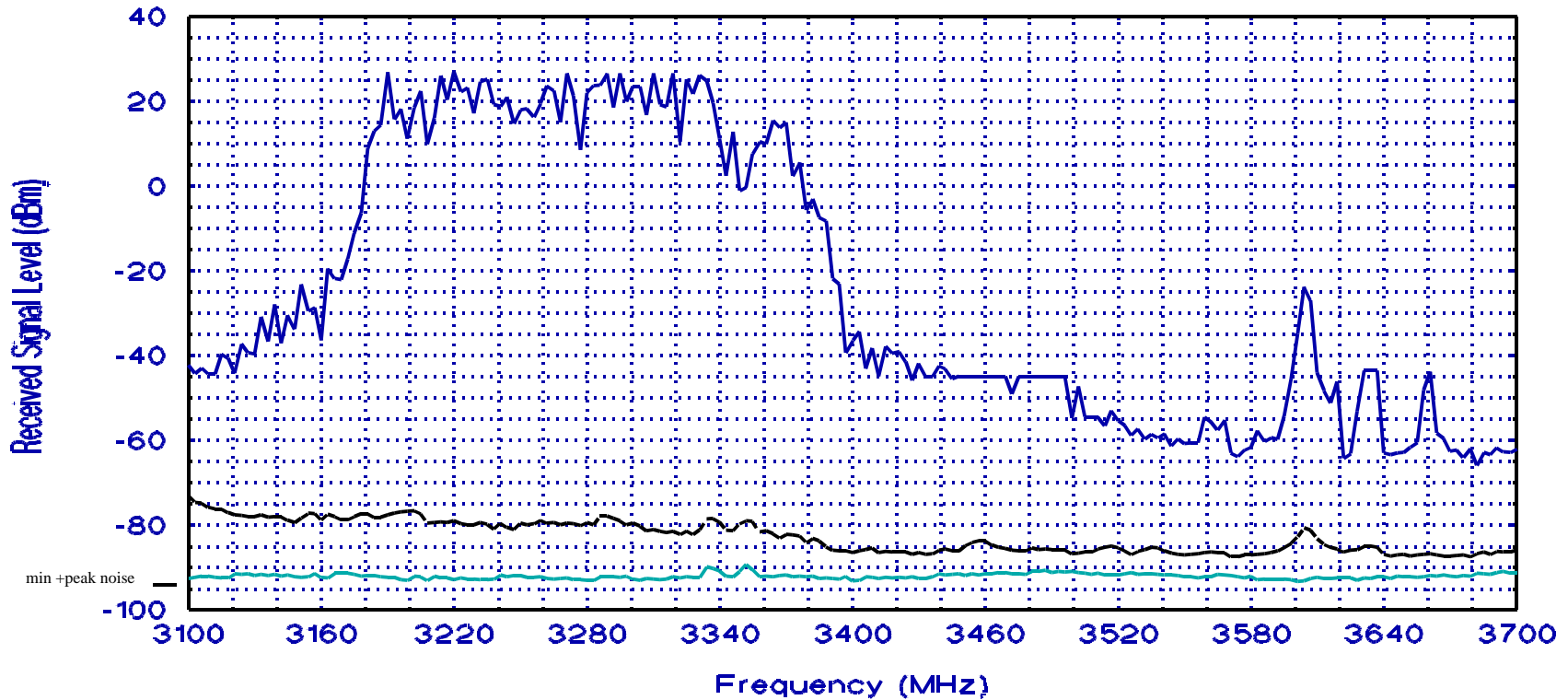

1. AERONAUTICAL RADIONAVIGATION (Ground-based).
2. Radiolocation.

3. Primarily, military airborne, land-based, and shipborne defense radars.

Figure 30. NTIA spectrum survey graph summarizing 46 scans across the 3100-3700 MHz range (System-2, band event 15, stepped algorithm, +peak detector, 3000-kHz bandwidth) at San Diego, CA, 1995.

GOVERNMENT ALLOCATIONS:	
NON-GOVERNMENT ALLOCATIONS:	FIXED, FIXED-SATELLITE (space-to-Earth).
GENERAL UTILIZATION:	Domestic public fixed, satellite communications.

3700

4200

46

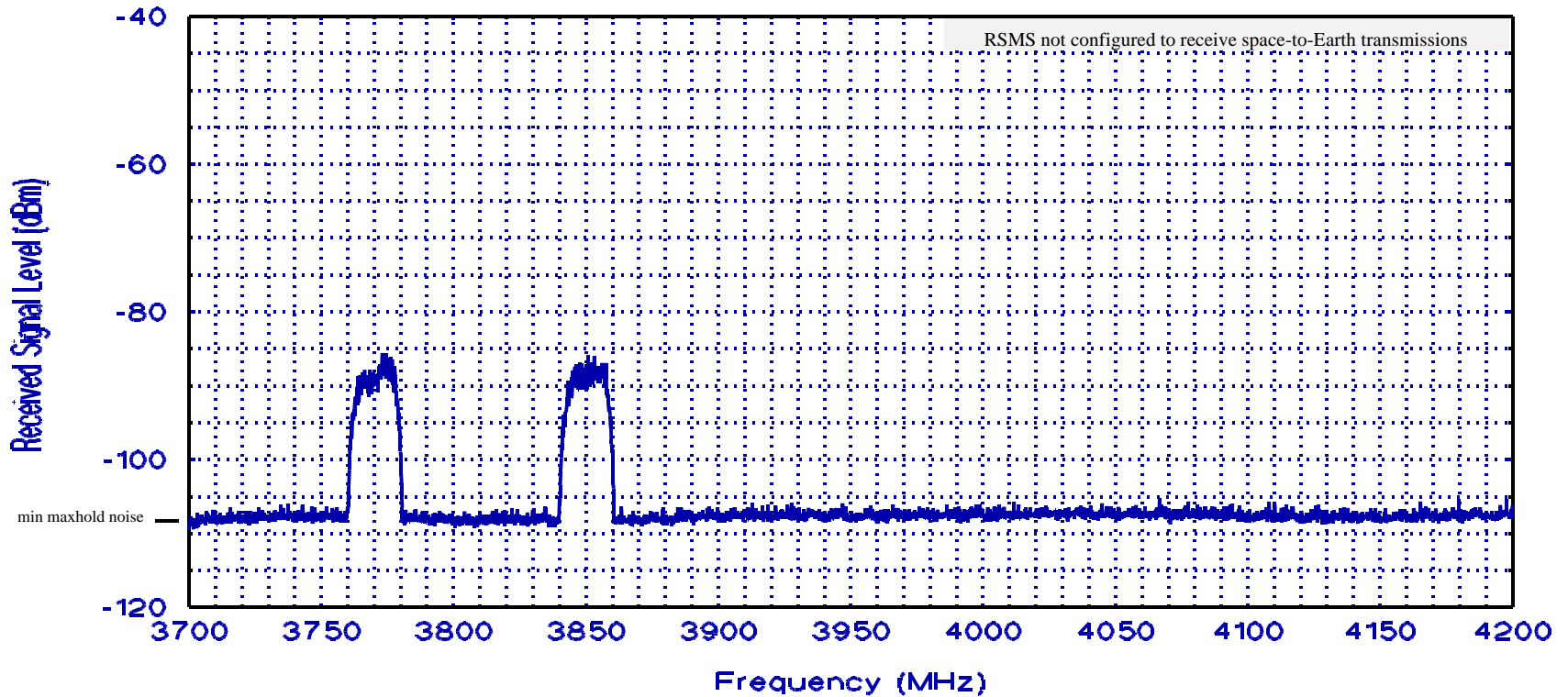

Figure 31. NTIA spectrum survey azimuth-scan graph of the 3700-4200 MHz range (System-2, band event 16, swept algorithm, maximum-hold detector, 100-kHz bandwidth) at San Diego, CA, 1995.

GOVERNMENT ALLOCATIONS:	AERONAUTICAL RADIONAVIGATION, 1.
NON-GOVERNMENT ALLOCATIONS:	AERONAUTICAL RADIONAVIGATION, 1.
GENERAL UTILIZATION:	Airborne radio altimeters.

4200

4400

47

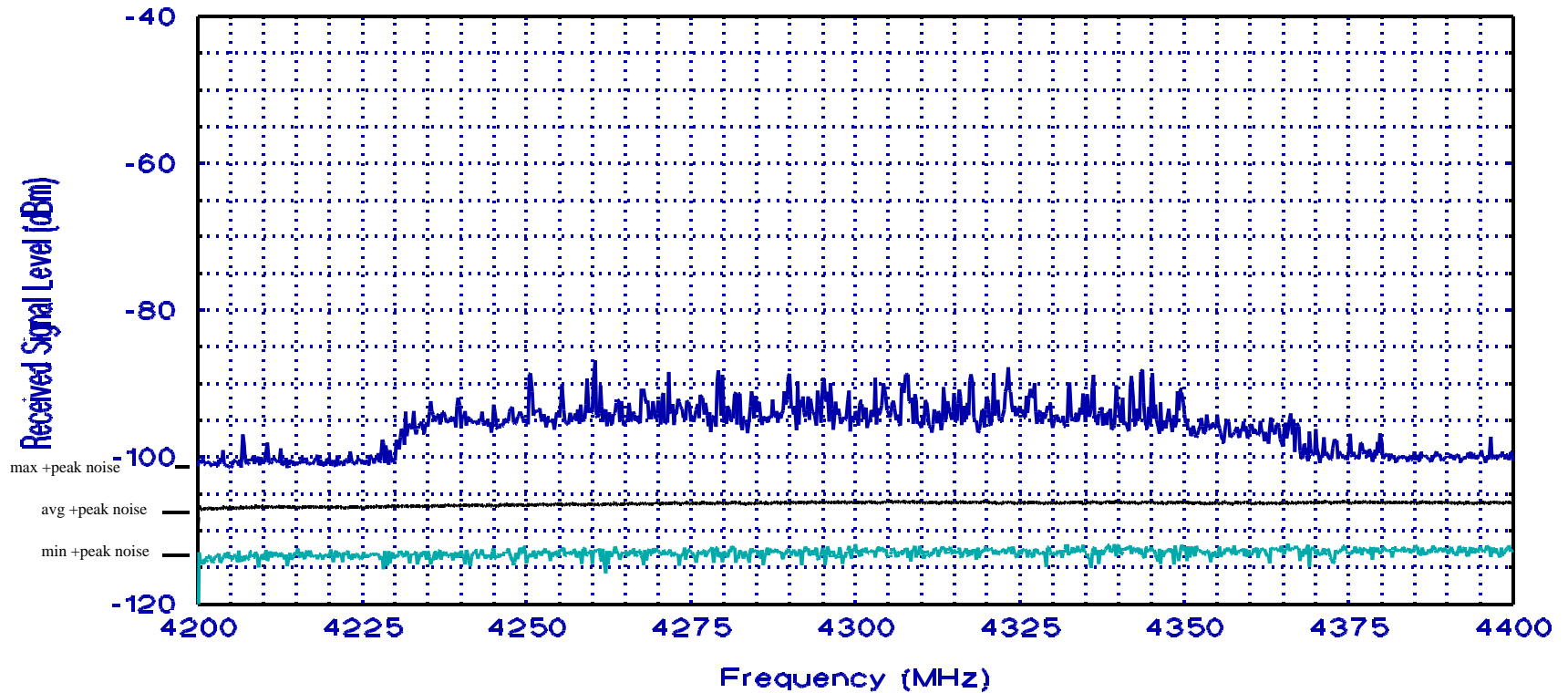

1. 4202 ±12 MHz: Standard frequency and time satellite service (space-to-Earth), permitted.

Figure 32. NTIA spectrum survey graph summarizing 32,500 sweeps across the 4200-4400 MHz range (System-2, band event 17, swept/m3 algorithm, +peak detector, 300-kHz bandwidth) at San Diego, CA, 1995.

GOVERNMENT ALLOCATIONS:	FIXED, MOBILE, 1.		2.
NON-GOVERNMENT ALLOCATIONS:		FIXED-SATELLITE (space-to-Earth).	2.
GENERAL UTILIZATION:	Narrowband and wideband uplinks and downlinks.		
	4400	4500	4800
			4990-5000

48

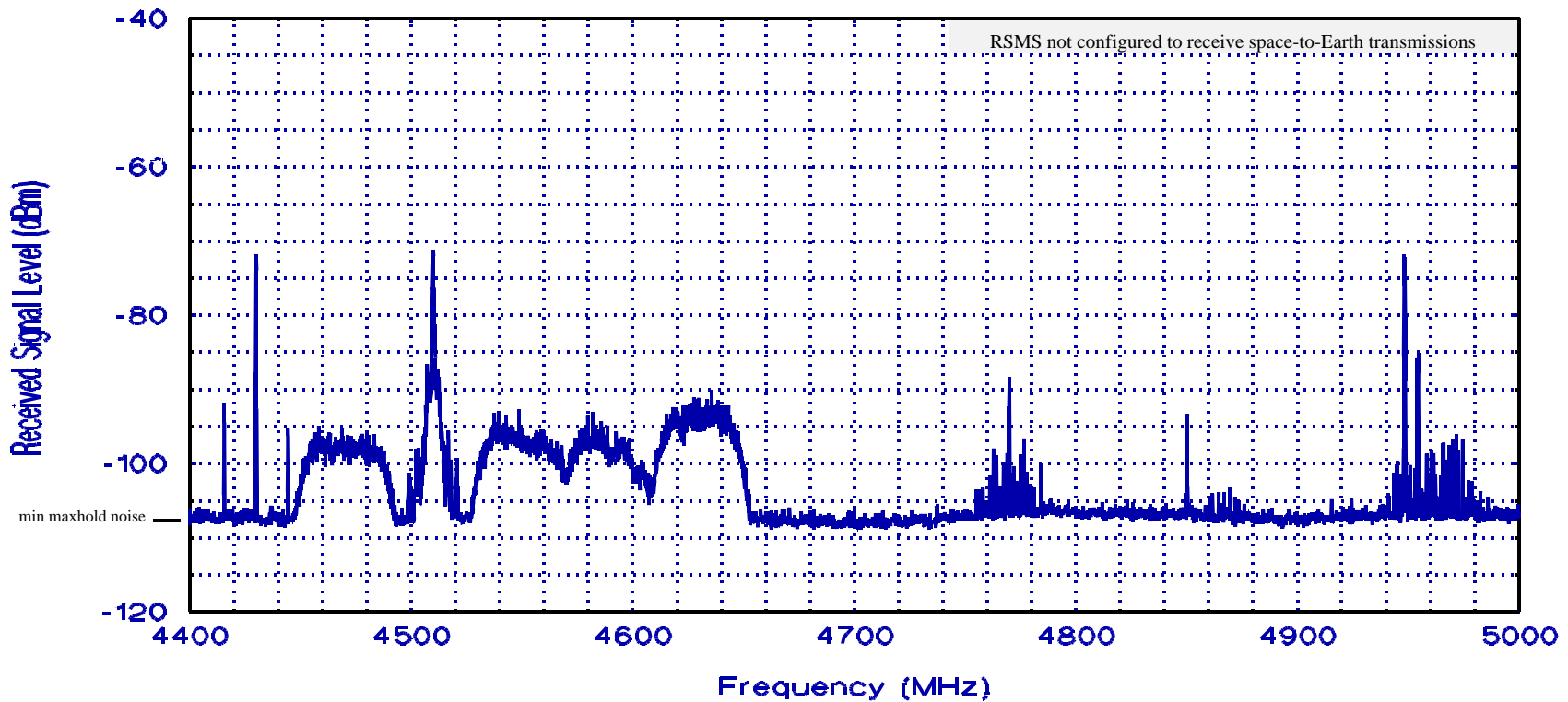

1. 4660-4685 MHz: No Government allocation after August 1994.

2. RADIO ASTRONOMY, Space Research (Passive).

Figure 33. NTIA spectrum survey azimuth-scan graph of the 4400-5000 MHz range (System-2, band event 18, swept algorithm, maximum-hold detector, 100-kHz bandwidth) at San Diego, CA, 1995.

GOVERNMENT ALLOCATIONS:	AERONAUTICAL RADIONAVIGATION.	
NON-GOVERNMENT ALLOCATIONS:	AERONAUTICAL RADIONAVIGATION.	
GENERAL UTILIZATION:	Microwave landing systems.	

5000

5250

49

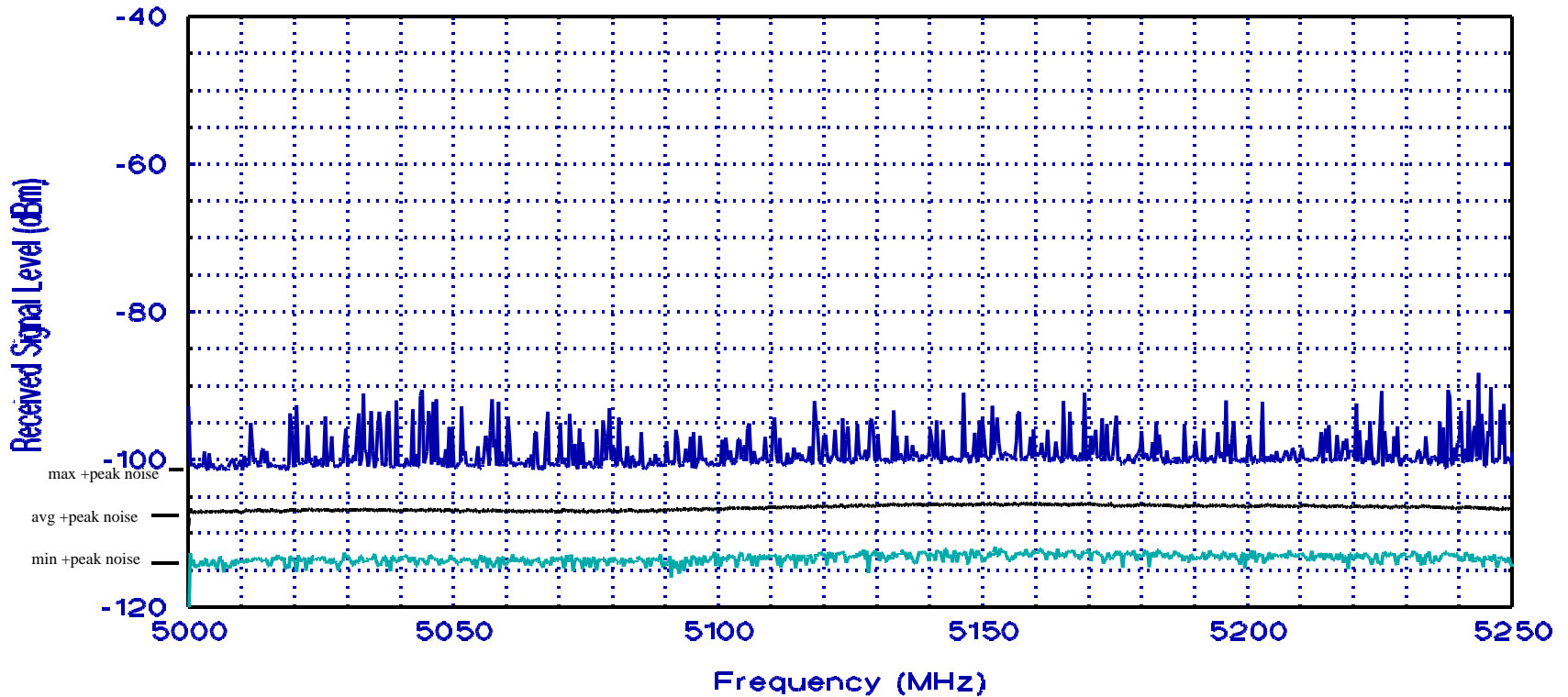
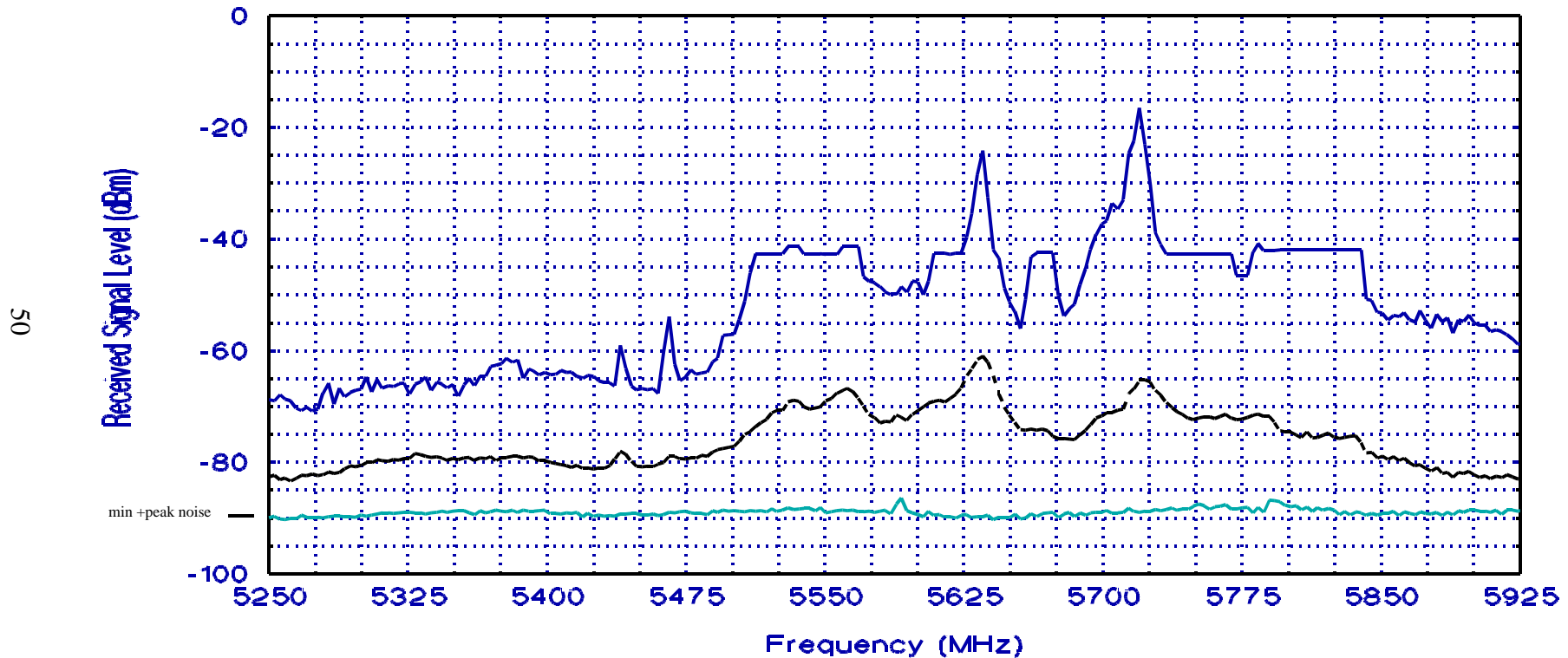

Figure 34. NTIA spectrum survey graph summarizing 32,000 sweeps across the 5000-5250 MHz range (System-2, band event 19, swept/m3 algorithm, +peak detector, 300-kHz bandwidth) at San Diego, CA, 1995.

GOVERNMENT ALLOCATIONS:	RADIOLOCATION.	AERONAUTICAL RADIONAVIGATION, 1.	3.	MARITIME RADIONAVIGATION, Radiolocation.	4.	RADIOLOCATION.	
NON-GOVERNMENT ALLOCATIONS:	Radiolocation.	AERONAUTICAL RADIONAVIGATION, 2.	3.	MARITIME RADIONAVIGATION, Radiolocation.	4.	Amateur.	6.
GENERAL UTILIZATION:				Weather radars.	5.	Military radars, 7.	7.
	5250	5350	5460-5470	5600	5650	5850	5925



- | | |
|------------------------------------------------------------------|----------------------------------------------------------------------------|
| 1. RADIOLOCATION. | 5. Government weather radars, e.g., Terminal Doppler Weather Radar (TDWR). |
| 2. Radiolocation. | 6. FIXED-SATELLITE (Earth-to-space), Amateur. |
| 3. RADIONAVIGATION, Radiolocation. | 7. 5725-5875 MHz: Industrial, scientific, and medical (ISM). |
| 4. MARITIME RADIONAVIGATION, METEOROLOGICAL AIDS, Radiolocation. | |

Figure 35. NTIA spectrum survey graph summarizing 22 scans across the 5250-5925 MHz range (System-2, band event 20, stepped algorithm, +peak detector, 3000-kHz bandwidth) at San Diego, CA, 1995.

GOVERNMENT ALLOCATIONS:					
NON-GOVERNMENT ALLOCATIONS:	FIXED, FIXED-SATELLITE (Earth-to-space).	1.	FIXED, FIXED-SATELLITE (Earth-to-space).	FIXED-SATELLITE (Earth-to-space), 2.	2.
GENERAL UTILIZATION:	Common carrier fixed links.		Common carrier fixed links.	Common carrier fixed links.	
	5925	6425	6525	6875	7075 7125

151

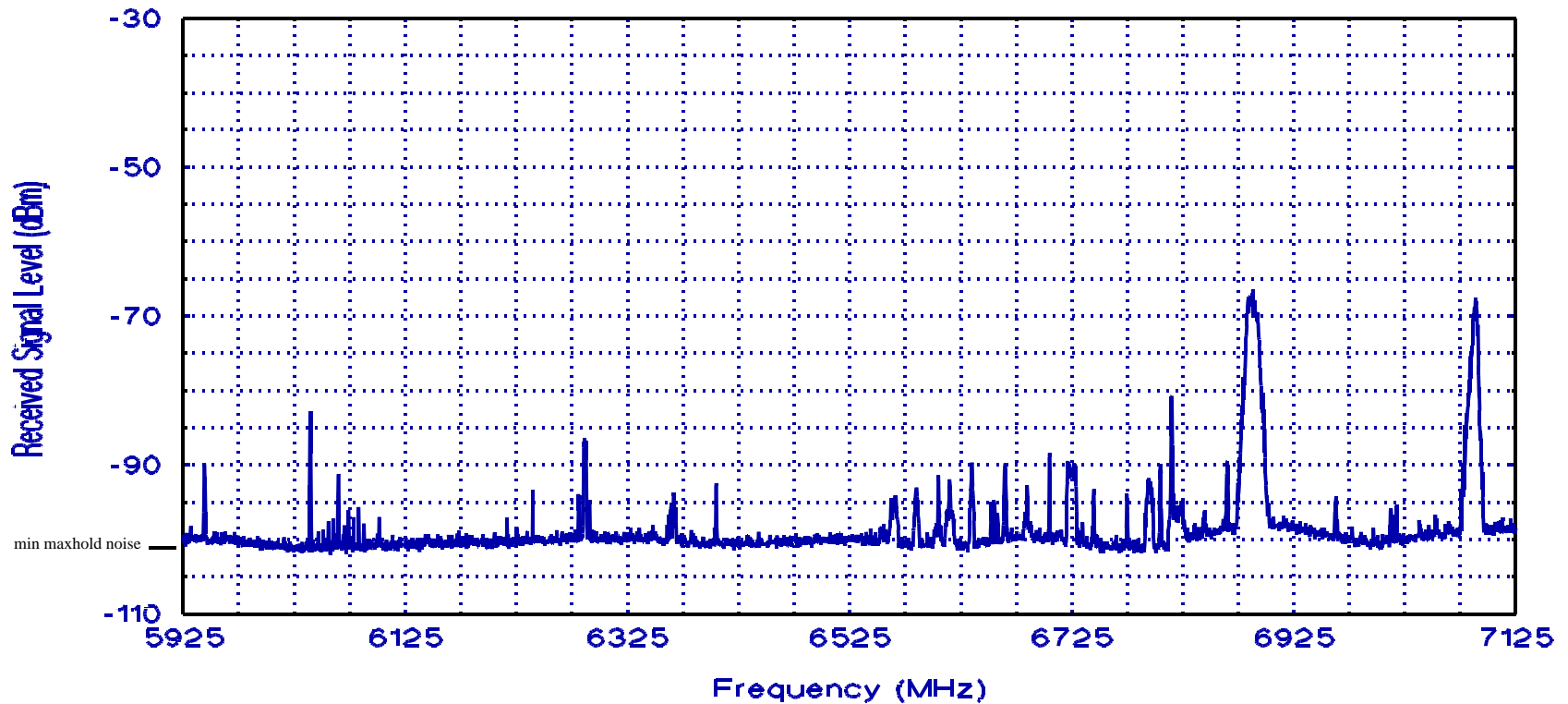

1. FIXED-SATELLITE (Earth-to-space), MOBILE.

2. FIXED, MOBILE.

Figure 36. NTIA spectrum survey azimuth-scan graph of the 5925-7125 MHz range (System-2, band event 21, swept algorithm, maximum-hold detector, 300-kHz bandwidth) at San Diego, CA, 1995.

GOVERNMENT ALLOCATIONS:	FIXED, 1.	3.	FIXED, FIXED-SATELLITE (space-to-Earth), Mobile-Satellite (space-to-Earth), 4.	FIXED.	FIXED-SATELLITE (Earth-to-space), 5, 6, 7.	FIXED, 8, 9.	
NON-GOVERNMENT ALLOCATIONS:							8.
GENERAL UTILIZATION:	2.	2.	2.	2.	2.	2.	2.

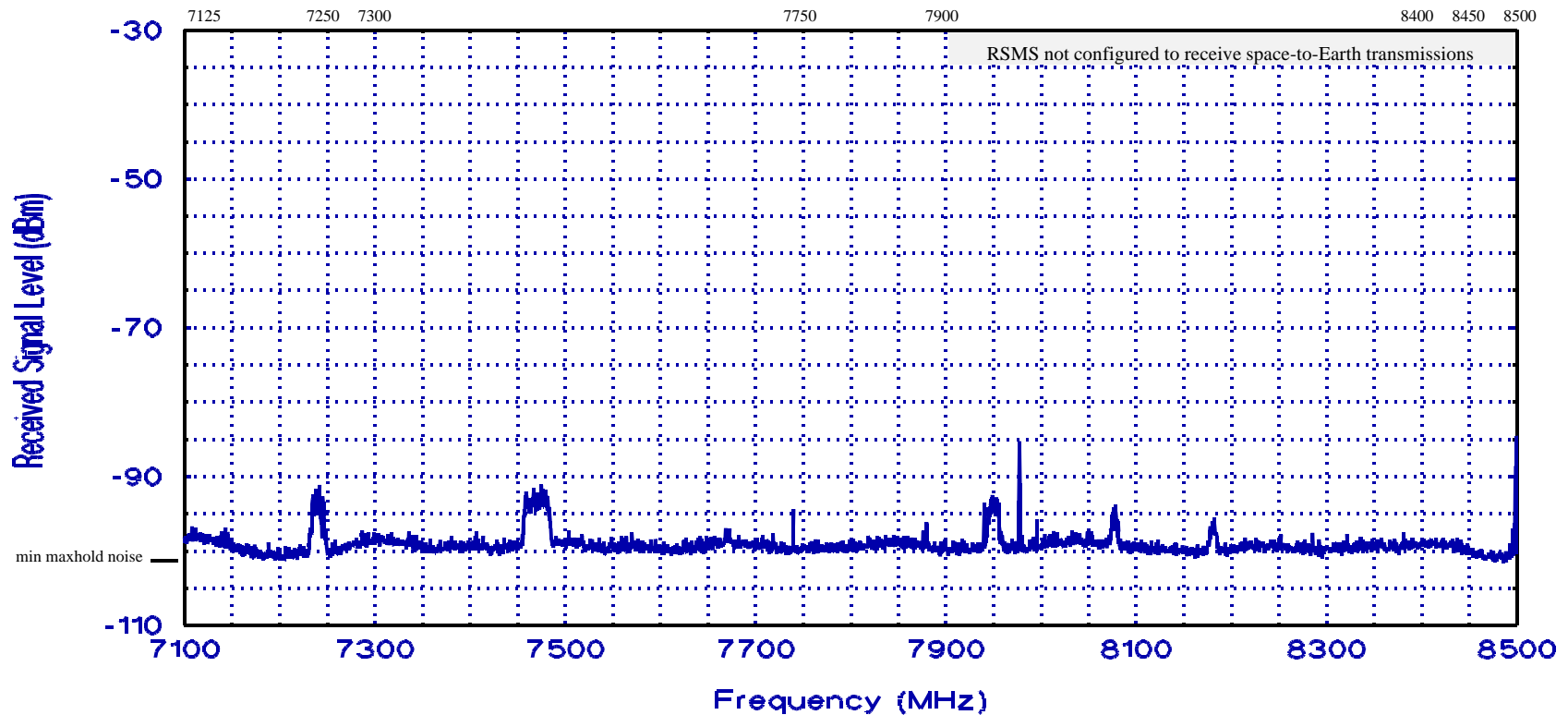

- | | |
|------------------------------------------------------------------------------------------------|---------------------------------------------------------------------------------------------------------------------------------------|
| 1. 7190-7235 MHz: SPACE RESEARCH (Earth-to-space). | 6. 8025-8400 MHz: EARTH EXPLORATION-SATELLITE (space-to-Earth), FIXED, Mobile-Satellite (Earth-to-space) (no airborne transmissions). |
| 2. Point-to-point microwave voice/data links, defense satellite communications systems (DSCS). | 7. 8175-8215 MHz: METEOROLOGICAL-SATELLITE (Earth-to-space). |
| 3. FIXED-SATELLITE (space-to-Earth), MOBILE-SATELLITE (space-to-Earth), Fixed. | 8. SPACE RESEARCH (space-to-Earth) (Government: 8400-8450 MHz deep space only). |
| 4. 7450-7550 MHz: METEOROLOGICAL-SATELLITE (space-to-Earth). | 9. 8400-8450 MHz: Deep space only. |
| 5. 7900-8025 MHz: MOBILE-SATELLITE (Earth-to-space), fixed. | |

Figure 37. NTIA spectrum survey azimuth-scan graph of the 7125-8500 MHz range (System-2, band event 22, swept algorithm, maximum-hold detector, 300-kHz bandwidth) at San Diego, CA, 1995.

GOVERNMENT ALLOCATIONS:	RADIOLOCATION.	1.	2.	3.	RADIOLOCATION.		
NON-GOVERNMENT ALLOCATIONS:	Radiolocation.	1.	2.	3.	Radiolocation.	Amateur, Radiolocation.	6.
GENERAL UTILIZATION:	Military use is primary.			4.	5.		

8500 9000 9200 9300 9500 10000 10450 10550

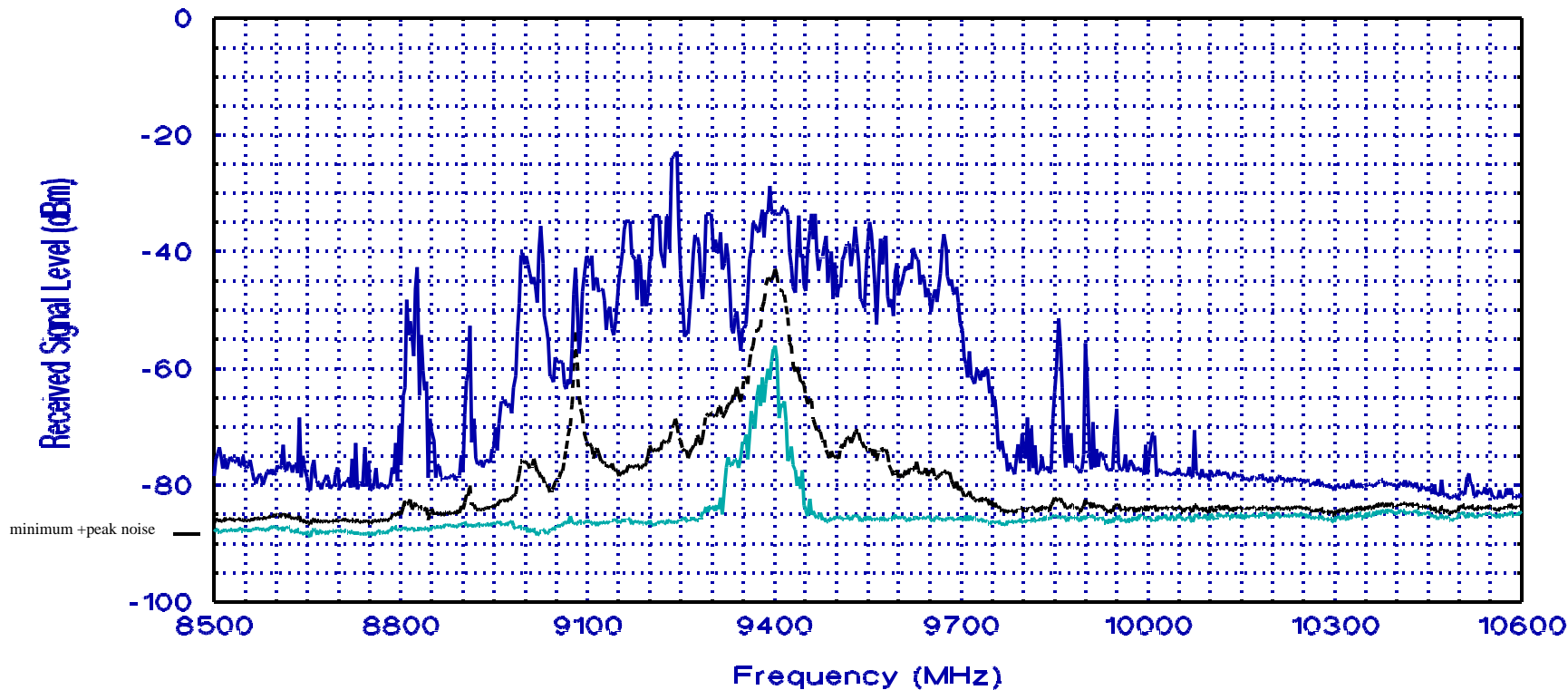

- | | |
|-------------------------------------------------------------------------------------------------------------------------------------------------------------------------------------------------------------------------|---------------------------------------------------------------------------------------------------------------------------------------------------------------------------------------------------------------------------------------------------------------|
| <ul style="list-style-type: none"> 1. AERONAUTICAL RADIONAVIGATION, Radiolocation. 2. MARITIME RADIONAVIGATION, Radiolocation. 3. RADIONAVIGATION, Meteorological Aids, Radiolocation. | <ul style="list-style-type: none"> 4. Maritime radionavigation radar, airborne weather radar, radar transponder beacons (RACONS). 5. Military airborne radar. 6. RADIOLOCATION. 10450-10500 MHz: Amateur, Amateur-Satellite. |
|-------------------------------------------------------------------------------------------------------------------------------------------------------------------------------------------------------------------------|---------------------------------------------------------------------------------------------------------------------------------------------------------------------------------------------------------------------------------------------------------------|

Figure 38. NTIA spectrum survey graph summarizing 23 scans across the 8500-10550 MHz range (System-2, band event 23, stepped algorithm, +peak detector, 3000-kHz bandwidth) at San Diego, CA, 1995.

GOVERNMENT ALLOCATIONS:	1.				
NON-GOVERNMENT ALLOCATIONS:	2.	FIXED, FIXED-SATELLITE (space-to-Earth).	FIXED-SATELLITE (space-to-Earth), 3.	FIXED, BROADCASTING-SATELLITE.	FIXED, FIXED-SATELLITE (Earth-to-space), MOBILE.
GENERAL UTILIZATION:		Common carrier point-to-point microwave links, television studio-to-transmitter links.		Direct broadcast satellite services (DBS).	Cable Relay Systems (CARS), 4.
	10550	10700	11700	12200	12700
					13250

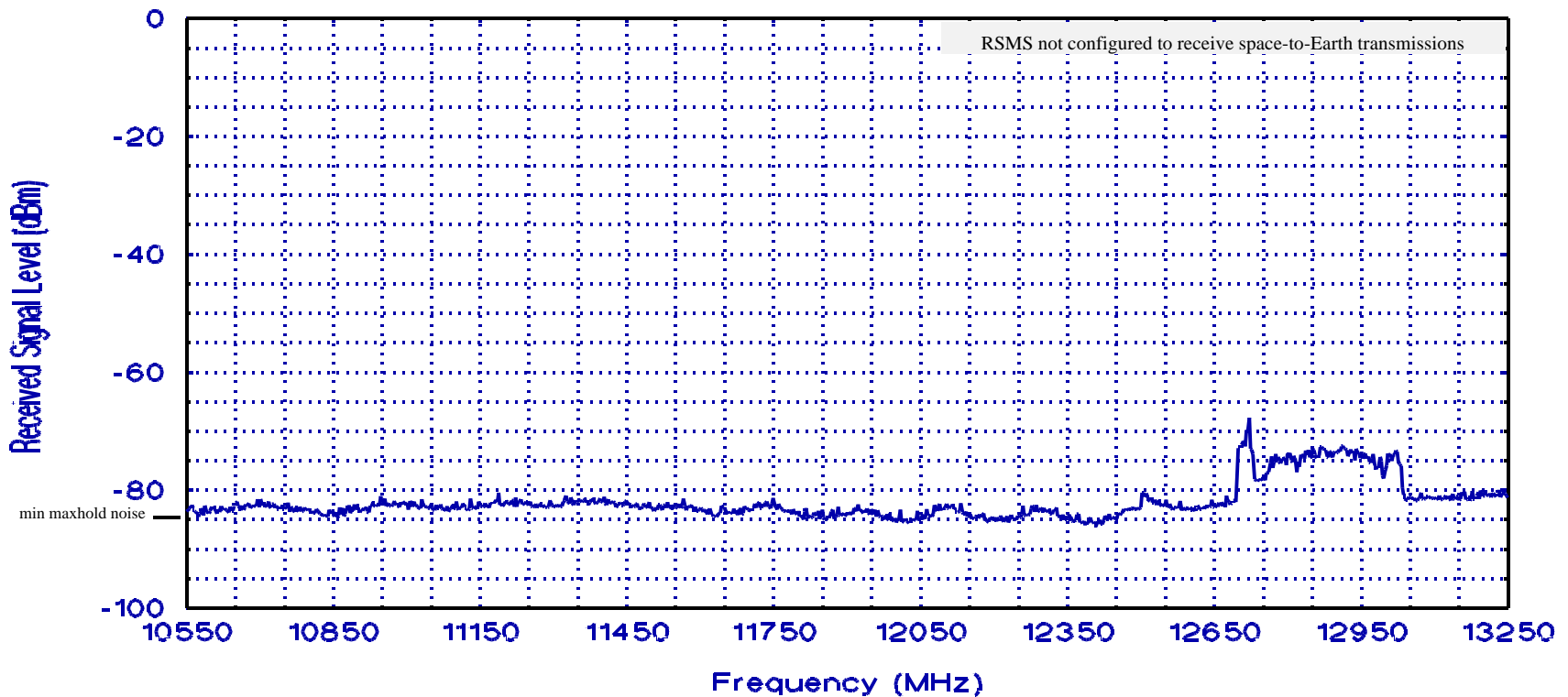

1. 10600-10700 MHz: EARTH EXPLORATION-SATELLITE (Passive), SPACE RESEARCH (Passive). 10680-10700 MHz: RADIO ASTRONOMY.
2. 10550-10680 MHz: FIXED. 10600-10700 MHz: EARTH EXPLORATION-SATELLITE (Passive), SPACE RESEARCH (Passive). 10680-10700 MHz: RADIO ASTRONOMY.
3. Mobile except aeronautical mobile.
4. Television auxiliary broadcasting (includes: SHL, STL, ENG, and ICR's).

Figure 39. NTIA spectrum survey azimuth-scan graph of the 10550-13250 MHz range (System-2, band event 24, swept algorithm, maximum-hold detector, 3000-kHz bandwidth) at San Diego, CA, 1995.

GOVERNMENT ALLOCATIONS:	AERONAUTICAL RADIONAVIGATION, 1.	RADIOLOCATION, Space Research, Standard Frequency and Time Signal-Satellite (Earth-to-space).	RADIONAVIGATION, Space Research.	
NON-GOVERNMENT ALLOCATIONS:	AERONAUTICAL RADIONAVIGATION, 1.	Radiolocation, Space Research, Standard Frequency and Time Signal-Satellite (Earth-to-space).	RADIONAVIGATION, Space Research, 2.	
GENERAL UTILIZATION:		Military airborne radars.		

13250

13400

14000

14200

SS

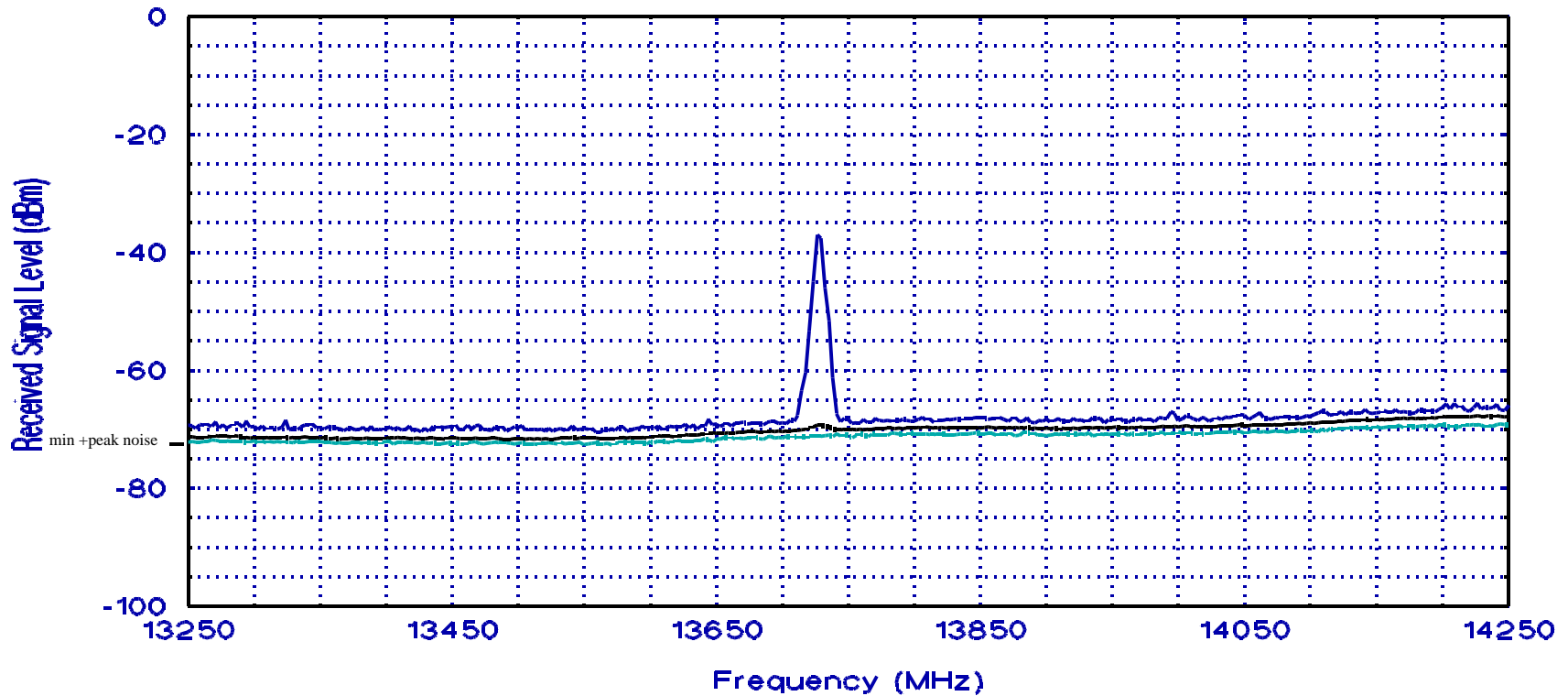

1. Space Research (Earth-to-space).

2. FIXED-SATELLITE (Earth-to-space).

Figure 40. NTIA spectrum survey graph summarizing 40 scans across the 13250-14200 MHz range (System-2, band event 25, stepped algorithm, +peak detector, 3000-kHz bandwidth) at San Diego, CA, 1995.

GOVERNMENT ALLOCATIONS:		Fixed, Mobile.	FIXED, Mobile, Space Research.	MOBILE, Fixed, Space Research.	FIXED, Mobile, Space Research.	3.	AERONAUTICAL RADIONAVIGATION.
NON-GOVERNMENT ALLOCATIONS:	FIXED-SATELLITE (Earth-to-space).	1.				3.	AERONAUTICAL RADIONAVIGATION.
GENERAL UTILIZATION:			2.		2.		

14200 14400 14500 14714.5 15136.5 15350-15400 15700

96

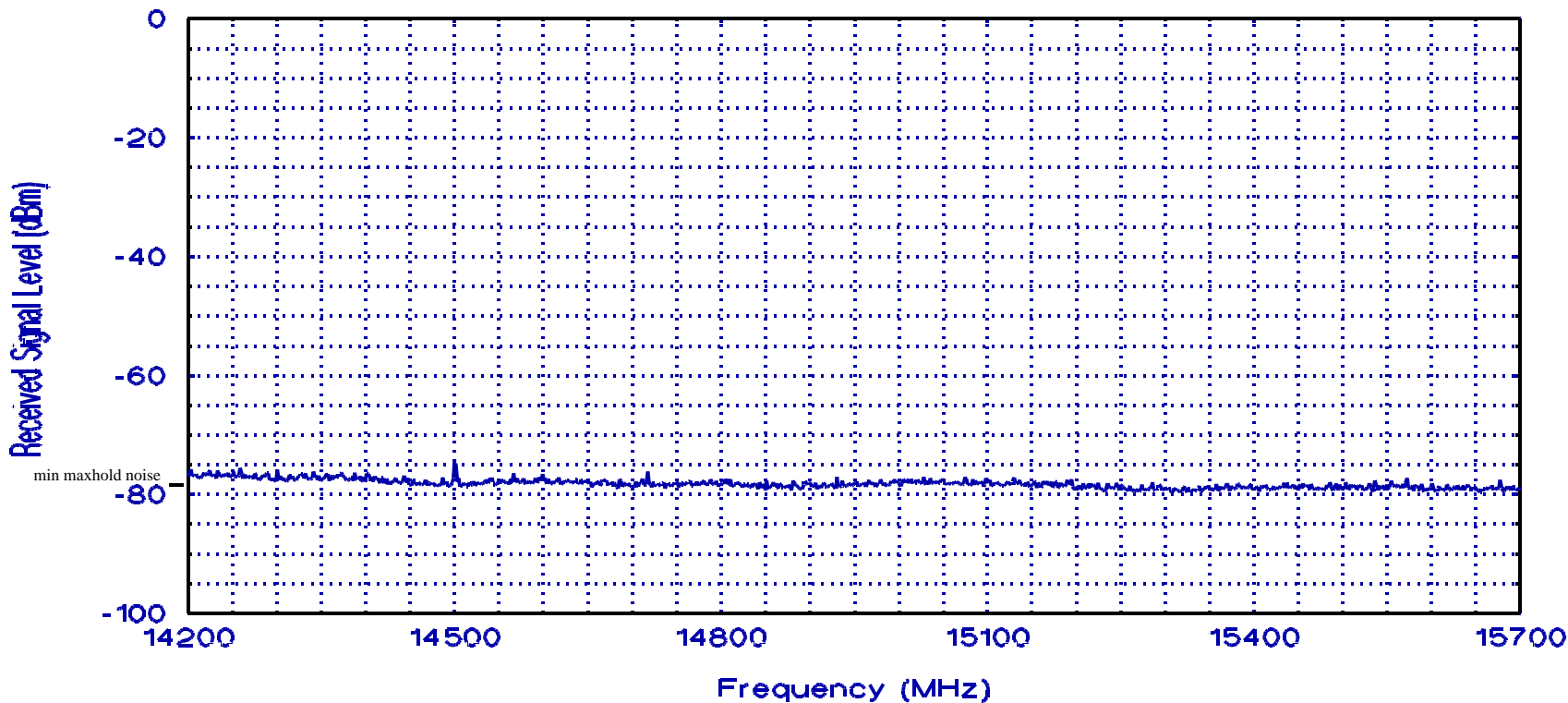

- 1. FIXED-SATELLITE (Earth-to-space).
- 2. Military communication links and microwave links. Air traffic control links, including video data.
- 3. EARTH EXPLORATION-SATELLITE (Passive), RADIO ASTRONOMY, SPACE RESEARCH (Passive).

Figure 41. NTIA spectrum survey azimuth-scan graph of the 14200-15700 MHz range (System-2, band event 26, swept algorithm, maximum-hold detector, 3000-kHz bandwidth) at San Diego, CA, 1995.

GOVERNMENT ALLOCATIONS:	RADIOLOCATION.	RADIOLOCATION, Space Research (Deep Space) (Earth-to-space).	1.	3.	Radiolocation.
NON-GOVERNMENT ALLOCATIONS:	Radiolocation.	Radiolocation.	2.	4.	FIXED-SATELLITE (Earth-to-space).
GENERAL UTILIZATION:	Military airborne radars.	Military airborne radars.			

15700

16600

17100 17200 17300

17700

57

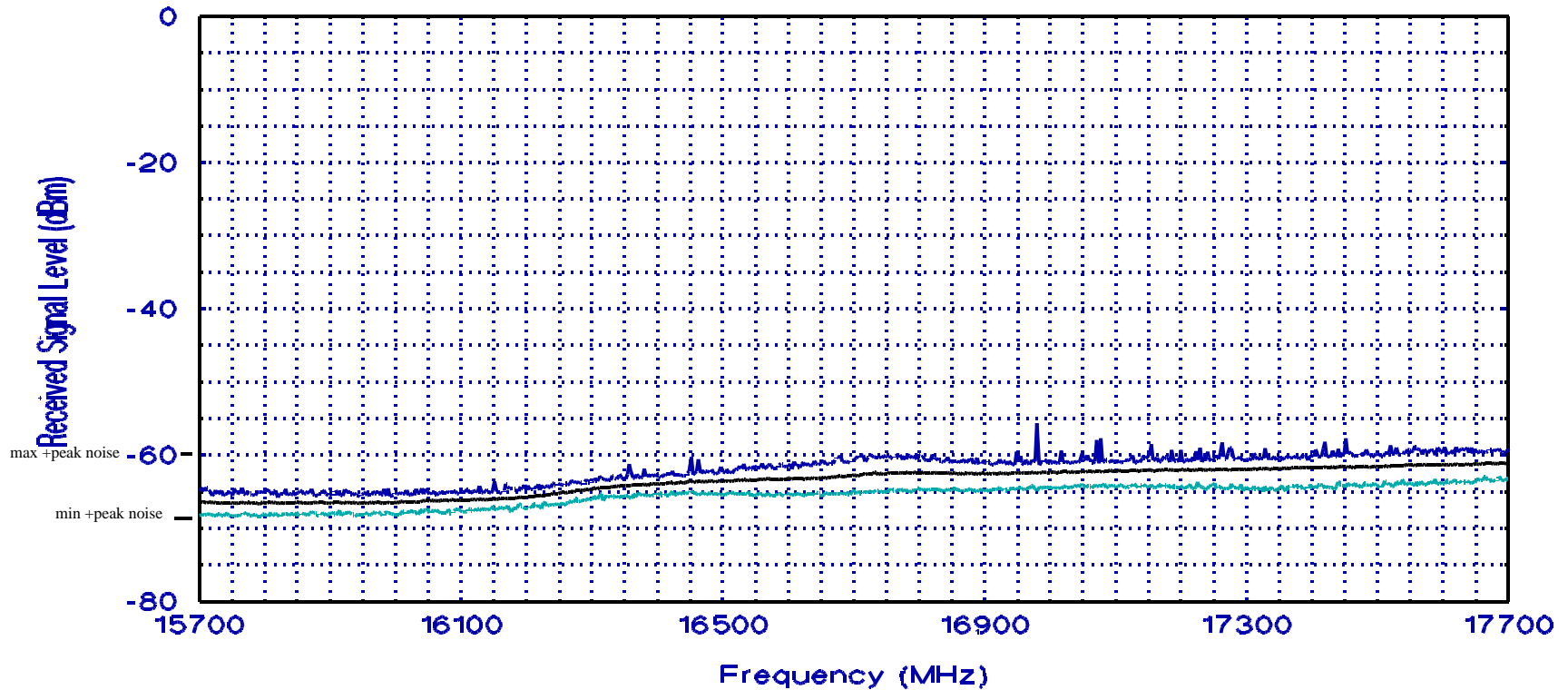

1. RADIOLOCATION.
2. Radiolocation.

3. RADIOLOCATION, Earth Exploration-Satellite (Active), Space Research (Active).
4. Earth Exploration-Satellite (Active), Radiolocation, Space Research (Active).

Figure 42. NTIA spectrum survey graph summarizing 39 scans across the 15700-17700 MHz range (System-2, band event 27, stepped algorithm, +peak detector, 3000-kHz bandwidth) at San Diego, CA, 1995.

GOVERNMENT ALLOCATIONS:		2.	
NON-GOVERNMENT ALLOCATIONS:	FIXED, MOBILE, FIXED-SATELLITE (space-to-Earth), 1.	3.	FIXED, FIXED-SATELLITE (space-to-Earth), MOBILE.
GENERAL UTILIZATION:	General purpose point-to-point microwave band including private, common carrier, cable television relay systems (CARS), studio-to-transmitter (STL) television links, Digital Electronic Message Services (DEMS), etc.		

17700

18600

18800

19700

58

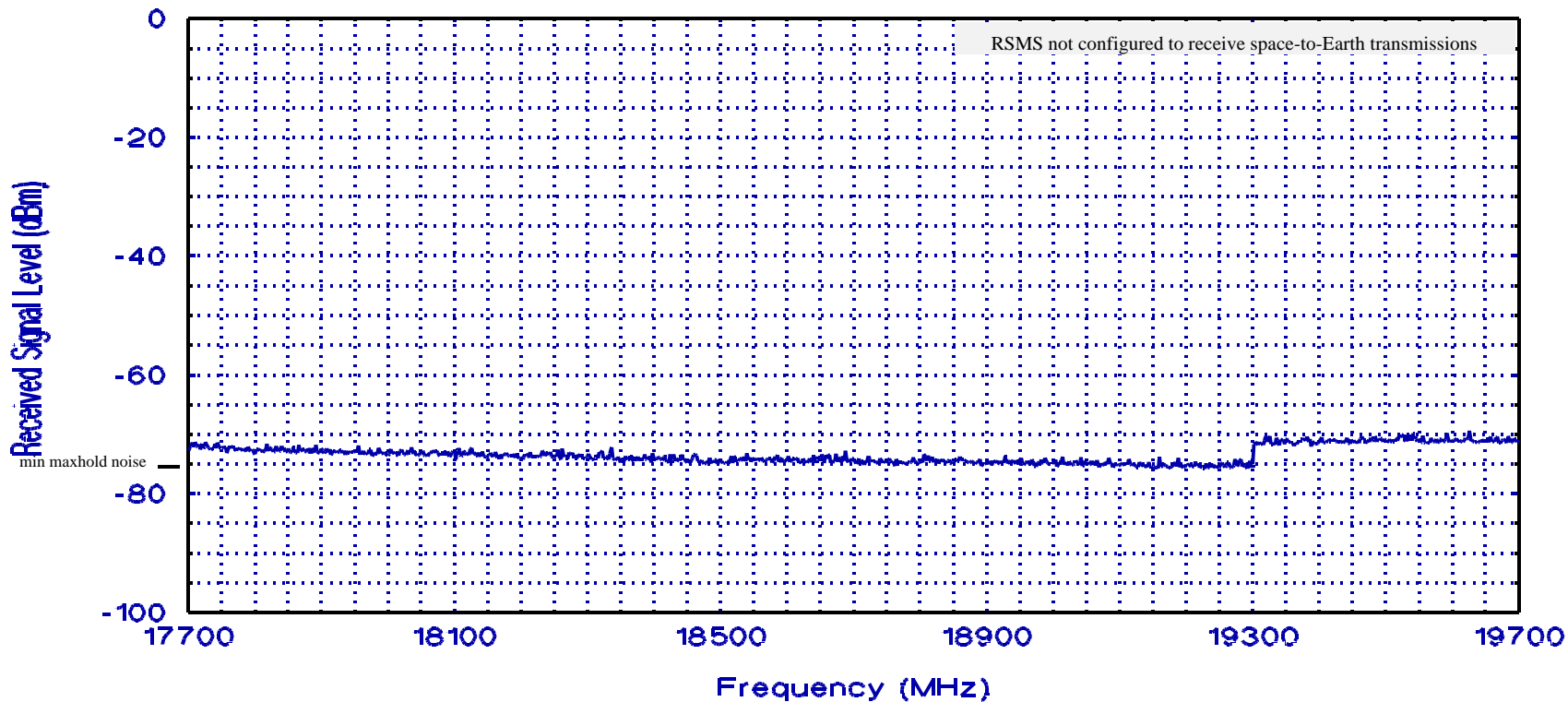

1. 17700-17800 MHz: FIXED-SATELLITE (Earth-to-space).

2. EARTH EXPLORATION-SATELLITE (Passive), SPACE RESEARCH (Passive).

3. FIXED, FIXED-SATELLITE (space-to-Earth), EARTH EXPLORATION-SATELLITE (Passive), MOBILE (exc. aeronaut. mobile), SPACE RESEARCH (Passive).

Figure 43. NTIA spectrum survey azimuth-scan graph of the 17700-19700 MHz range (System-2, band event 28, swept algorithm, maximum-hold detector, 3000-kHz bandwidth) at San Diego, CA, 1995.

measured with different bandwidths and algorithms. This is the case for Figures 21 and 22. Figure 22 covers the same frequency range as the upper 25% of Figure 21, but the appearance of the two graphs is completely different. The signals in Figure 22 appear (at first glance) to be much stronger and denser than those in the common part of Figure 21.

The previous two examples are given as a caution to the reader that each survey band is intended to best describe the signal environment within its frequency range and is not, generally comparable to other survey bands. The summary observations of Section 3.5 should be of help with interpretation of the data graphs.

3.5 Observations on Measured Data and Spectrum Use

It is important to understand what aspects of spectrum use can be extrapolated from the RSMS data presented in this report, and also what aspects of spectrum use cannot be inferred from these data. First, the data acquisition was performed at a single location in the San Diego metropolitan area during a two-week period spanning the end of February and the beginning of March 1995. In most measured bands, the RSMS data presented in this report show maximum, minimum, and average measured power levels of received signals. In these bands, the cumulative measurement time during the survey was typically several hours, spread uniformly over the diurnal cycle. For some bands that were nondynamic and measured with the azimuth-scanning technique, only a single occupancy curve is shown.

Based on the measurement and sampling techniques used, we believe that these data represent an extremely good statistical sampling of the activity in the radio spectrum in the San Diego metropolitan area. Maximum and minimum activity levels measured in the spectrum are probably very good representations of actual activity levels. The average curves provide a good qualitative estimate of the typical received power as a function of frequency. The maximum, minimum, and average curves can also be used to qualitatively assess the relative density of channel occupancy on a band-by-band basis. In the azimuth-scan bands, the single curve which is shown likewise provides a good estimate of the density of spectrum occupancy in the survey area.

However, while the data presented here can be used to infer the density of frequency occupancy, these data *cannot* be used to infer the statistical percentage of time that channels are occupied. A good analogy is to imagine counting houses while driving along a street: one can easily count the number of houses that have been built on each block (analogous to counting the number of frequencies that show activity in each band in the RSMS survey), but one cannot tell, on the basis of that count, what percentage of time the houses are occupied. Signals that are observed in 100% of the scans can be determined, because the minimum curve will show such activity. Other than 100% signals, the average curves provide a qualitative, not quantitative, measure of occupancy for the measured frequencies.

There is an RSMS measurement technique for obtaining absolute channel occupancy statistics. Measurements of this type were performed (in mobile radio bands) in conjunction with the RSMS occupancy survey in San Diego. Results of those measurements will be published separately.

3.5.1 Band-by-band Observations on Spectrum Use in the San Diego Area

Table 7 contains band-by-band observations on spectrum occupancy in the San Diego area. The comments are based on examination of the RSMS data collected during the spectrum survey and frequency allocation information in the NTIA Manual [1, Chapter 4].

Table 7. Comments on San Diego Spectrum Occupancy Measurement Results

Spectral Range	Figure	Comments
108-138 MHz	4	<p>Across the 108-114 MHz range, 40 dB of RF attenuation were used in the RSMS front-end to prevent overload by signals in the adjacent 88-108 MHz commercial FM radio broadcast band. This raised the RSMS noise floor in this range by 40 dB relative to the rest of the band, and reduced RSMS sensitivity to signals in the 108-114 MHz range by the same amount.</p> <p>Instrument landing system (ILS) localizes transmit in the 108-112 MHz range, but detection was not expected due to the high RSMS noise figure in this range. However, an ILS glideslope signal is observed at 333 MHz. Across 108-118 MHz, very-high frequency omnidirectional range (VOR) aeronautical navigation beacons are observed as 100% emitters. These are seen as vertical lines coming up from the minimum curve. Also, in the air traffic control (ATC) band across 118-136 MHz, automated terminal information service transmissions appear as high-average or 100% signals. Frequently used ATC frequencies also appear as high points on the average curve. Air mobile frequencies that were used at least once during the survey are observed on the maximum curve. A large number of the available channels in the ATC band were used during the survey period.</p> <p>In the 137-138 MHz band, television infrared observation satellite signals are not receivable by the RSMS. NOAA weather satellites operate at 137.62 MHz. Signal occupancy observed at 137.6 MHz (at about -60 dBm) is stronger than expected for a NOAA weather satellite.</p>
138-162 MHz	5	<p>A large number of mobile and amateur signals are observed in the 138-148 MHz portion of the spectrum. The average curve is significantly raised across 144-148 MHz, used by amateurs. Between 148-162 MHz, a large percentage of available channels also show use. Transmitters between 152-153 MHz were in operation continuously during the survey period.</p> <p>Maritime mobile signals occur between 156.2475-162.025 MHz. All of these channels show some occupancy, consistent with expectations for the San Diego area.</p> <p>During the survey, routine station identification monitoring indicated unauthorized use of frequencies at and near 150 MHz in the San Diego area. This information was sent to the FCC Field Enforcement Bureau, which later located several unauthorized sources in southern California, including fishing boats offshore.</p>

Table 7. Comments on San Diego Spectrum Occupancy Measurement Results (Continued)

Spectral Range	Figure	Comments
162-174 MHz	6	A variety of fixed and mobile signals are observed. The signal near 162.5 MHz is a public broadcast weather information channel. Essentially all of the channels in this band show some occupancy during the survey period, and many channels raise the average curve.
174-216 MHz	7	Television broadcast channels 8, 10, and 12 are occupied. Adjacent broadcast channels are unoccupied, in accordance with FCC regulations. Twenty dB attenuation was used to prevent front-end overload in RSMS.
216-225 MHz	8	Some channels are used in the 216-220 MHz maritime mobile allocation. Signals that are possibly from a trunked system occur between 220-220.75 MHz. Identical received amplitudes of five signals between 220-220.7 MHz implies the possibility of a single, fixed location of origin. These signals may be from an LMR base station. Amateur signals are observed above 221 MHz, and the relative density of channel occupancy increases above 223.5 MHz. No military radiolocation occurs in this spectral range in the San Diego area.
225-400 MHz	9	Military ATC communications are observed. Many of these signals are 100% transmissions from fixed locations. Even signals that are less than 100% often are used enough of the time to significantly affect the average curve. ILS glideslope signal is observed "at about 333 MHz.
400-406 MHz	10	Fifteen to twenty signals are observed in this meteorological aids band for brief intervals during the survey period. The relative paucity of observed signals is consistent with typically low EIRP and typically intermittent operation of most systems that use this band (e.g., radiosonde).
406-420 MHz	11	A number of fixed and mobile signals (about 30) affecting the minimum and average curves, are observed. Four of the signals are observed in 100% of RSMS data scans.
420-450 MHz	12	High-power radar signals produce essentially all of the occupancy observed in this band. Some of these signals saturated the RSMS at amplitudes in excess of -25 dBm in 50 ohms, with the omnidirectional receiving antenna. The radars are on ships and naval aircraft. Compare the high level of activity in this band in the San Diego area with practically nonexistent activity in the same band in the Denver, Colorado area [2].
450-470 MHz	13	A large number of land mobile signals are observed, and many of them affect the average curve. The band edges of the 460-465 MHz base station allocation are very distinct.

Table 7. Comments on San Diego Spectrum Occupancy Measurement Results (Continued)

Spectral Range	Figure	Comments
470-512 MHz	14	<p>Between 470-490 MHz, the RSMS front-end was operated with 30 dB RF attenuation to prevent front-end overload by the TV broadcast channel 15 signal. The rest of this band was measured without RF attenuation. The result is a noise floor that is 30 dB higher across 470-490 MHz than across the rest of the band.</p> <p>Television broadcast channels 15 and 19 are occupied by local San Diego stations. Channel 18 is occupied by station KSCI in Los Angeles. The rest of the occupancy observed in this band is generated by nontelevision transmitters.</p> <p>Spectrum nominally allocated for television broadcast channels 14, 16 and 20 shows use by the Los Angeles T-band land mobile radio allocation, as defined in the CFR [3, Part 90.311], for ten major urban areas in the United States. Base stations operate in the lower half of each channel, and mobile stations operate in the upper half of each channel. In particular, the lower half of channel 16 shows use by Los Angeles County public safety base stations for land mobile radio. Note that, although the T-band allocations are for Los Angeles, which is nominally well beyond line-of-sight from the RSMS location at Point Loma, spectrum occupancy by these systems is still readily observed in the San Diego area. This may be due to propagation from high terrain in the southern Los Angeles area, and/or to ducting phenomena.</p> <p>Channel 17 shows occupancy by low-power television in the San Diego area, and also by local area networks in Mexico.</p>
512-806 MHz	15	<p>All of the signals observed in this band appear to be UHF television broadcast. At least nine of them were observed in 100% of RSMS scans, the remainder having been turned off at least once during the survey.</p>
806-902 MHz	16	<p>Cellular, trunked, and public safety portions of this part of the spectrum are clearly delineated. Mobile and base parts of the band are also clearly identifiable,</p> <p>Within the 806-821 MHz (mobile conventional and trunked) band segment, most occupancy occurs between 811-821 MHz. The 821-824 MHz mobile public safety band shows occupancy by four signals, but the probability of intercept (POI) for such signals by the RSMS is low (compare to the 866-869 MHz base public safety band, below). The 824-849 MHz cellular mobile band shows enough use by mobile units to raise the average curve slightly. The 849-851 MHz ground-to-air allocation shows no measured occupancy, although the POI for such signals by the RSMS is low. The 851-866 MHz base conventional and trunked band shows occupancy that significantly raises the average curve. The 866-869 MHz base public safety shows occupancy on about twenty channels, and the average curve is affected. The 869-894 MHz band, occupied by cellular base stations, is distinctly observed. The 100% use channels between 879.3 -880.5 MHz are probably system control channels. Air-to-ground signals between 894-896 MHz are observed, confirming that low POI probably prevents the RSMS from measuring corresponding ground-to-air signals. A few signals are observed in the 896-901 private land mobile band, and a single signal was recorded in the 901-902 MHz general mobile allocation.</p>

Table 7. Comments on San Diego Spectrum Occupancy Measurement Results (Continued)

Spectral Range	Figure	Comments
902-928 MHz	17 & 18	<p>This band is measured two different ways: with the positive peak detector in maximum hold mode and 10-kHz IF bandwidth, as shown in Figure 17, and with the positive peak detector in stepped mode and 1-MHz bandwidth, as shown in Figure 18. The narrow-IF bandwidth, maximum-hold measurement is intended to show industrial, scientific and medical (ISM) and Part 15 device operations, while the wide-IF bandwidth, stepped algorithm is intended to optimize the RSMS for measurement of radar signals in the band. For the San Diego area, both algorithms produce band occupancy measurements that show a higher level of occupancy than was indicated in the Denver, Colorado survey measurements [2].</p> <p>A wide variety of systems operate in this band. These include, but are not limited to, high-power naval radars (primary allocation in the band), ISM devices, Part 15 devices, wireless local area networks (required to either use spread spectrum or frequency-hopping transmitters), automatic vehicle monitoring, digital communication systems, repeaters, and amateurs. Figure 17 shows the cumulative effect of nonradar devices on spectrum occupancy in this band. Radar emissions tend to be discriminated out of these data by the narrowband (10-kHz) IF. Maximum observed signal amplitude in this bandwidth is about -60 dBm on an omni antenna. Note that many of the signals are observed in 100% of RSMS data scans.</p> <p>Signals between 926-928 MHz are apparent intermodulation products from pager systems operating between 928-932 MHz.</p> <p>Figure 18, made with positive peak detection in a 1-MHz IF bandwidth, primarily shows activity of high-power naval radars. Note that, with the wider measurement bandwidth, which more closely matches the emission bandwidth of the radar signals, the maximum measured amplitude of the signals in the band exceeds a value of -30 dBm in 50 ohms, as received on the RSMS omni antenna.</p>
928-960 MHz	19	<p>Paging systems are observed between 928-932 MHz. Possible intermodulation products from these pagers are observed adjacent to this spectral range, between 926-928 MHz and 932-934 MHz.</p> <p>The 932-935 MHz point-to-point and point-to-multipoint band is clearly delineated, as is the 935-940 MHz land mobile band. Two signals were constantly present in the 941-944 MHz band for fixed, point-to-point, and point-to-multipoint communications. Most signals in the 944-960 MHz fixed band (auxiliary broadcasting, fixed private microwave, and studio-to-transmitter links) were present in 100% of RSMS data scans.</p>

Table 7. Comments on San Diego Spectrum Occupancy Measurement Results (Continued)

Spectral Range	Figure	Comments
960-1215 MHz	20	Activity in this band is produced entirely by aeronautical navigation aids. These include tactical air navigation beacons (TACAN), distance-measuring equipment (DME), and air traffic control radar beacon system (ATCRBS) interrogators and transponders. Probable TACAN signals appear as bumps in the average curve at (approximately) 978, 995, 1007, 1012, 1174, 1187, 1204, and 1212 MHz. DME airborne interrogations occur from 1025-1150 MHz; DME ground beacons reply between 962-1025 MHz and 1150-1213 MHz. Note the delineation that is visible at 1150 MHz. ATCRBS ground-based interrogations occur at 1030 MHz, and airborne replies occur at 1090 MHz. Both of these peaks are clearly visible in the data. Because the emissions in this band are primarily pulsed, the average curve is essentially unaffected by all signals except TACAN.
1215-1400 MHz	21	This band shows occupancy by high-power, long-range air search radars. Frequencies occupied by distinctly identifiable radar signals are 1255, 1270, (with other peaks noted at 1274-1282, 1314-1318, and 1359-1371 MHz), 1295, 1305, 1342, 1349, and 1392 MHz. The radar at 1255 MHz also operated briefly at 1250 MHz, and this occurred during a scan in which attenuation was not invoked in the RSMS; hence, this peak occurs as a shelf to the left of the peak at 1255 MHz. It is not known which of these radars, if any, generated the peak at 1265 MHz. All of the measured signals between these peaks are spurious emissions from these radars. Emission parameters vary, but values measured by the RSMS crew are typically as follows: mechanical beam rotation, 9-12 s rotation time, 1-6 us pulse widths, and 300-600 pulses per second transmitted. These radars usually are observed to emit staggered pulse trains, probably to enhance doppler processing of target returns.
1350-1400 MHz	22	Unlike the measurements made in the 1215-1400 MHz band, measurements in this band are optimized to observe nonradar emissions. Nevertheless, most of the activity observed in this band is from radars. The prominent features at 1350-1355, 1360-1372, and 1392 MHz are generated by the air search radars shown in Figure 21. No nonradar signals are noted in this band. Because they are pulsed signals received approximately every 9-12 s, the average and minimum curves are unaffected.
1400-1530 MHz	23	Six distinct signals are observed in this band by the RSMS. The frequencies are 1449, 1459, 1464, 1482, 1502, and 1512 MHz. Four of these signals are present in 100% of RSMS data scans.
1530-1710 MHz	24	Some signals are observed at 1610.5, 1625-1645, 1655-1665, and 1670-1690 MHz. We infer that the other signals are probably earth-to-space for maritime mobile satellite (allocated 1626.5 -1646.5 MHz), earth-to-space for aeronautical mobile satellite (allocated 1646.5 -1668.4 MHz), and radiosondes (allocated 1668.4-1700 MHz).

Table 7. Comments on San Diego Spectrum Occupancy Measurement Results (Continued)

Spectral Range	Figure	Comments
1710-2300 MHz	25	<p>All signals observed in this band are terrestrial point-to-point communications, as measured with the RSMS azimuth-scanning technique (see Section C.8 in Appendix C). As in the Denver, Colorado survey [2], two parts of this spectral range show a comparatively small number of transmitters: 1990-2110 MHz (terrestrial allocations being auxiliary broadcasting, cable TV, and GOES uplink), where four signals are observed, and 2200-2300 MHz (terrestrial allocation being fixed microwave links), where one digital and one analog signal occur. Note that all signals observed in this band in San Diego are analog, except for the digital signal at approximately 2262 MHz.</p>
2300-2500 MHz	26	<p>Four communications signals, probably analog, are observed at 2315, 2333, 2367, and 2383 MHz. Their significant effect on the average curve suggests that they likely are fixed links. Above 2388 MHz, all of the observed activity is background radiation generated by ISM devices, and especially by aggregate emissions from microwave ovens in the San Diego area. This background is observed at levels 10 dB higher than in the Denver, Colorado measurements [2]. See also Gawthrop, et al. [4], for further information on emission characteristics of microwave ovens.</p>
2500-2700 MHz	27	<p>At least 27 fixed transmitters are observed in this band. Some of the carriers are low-amplitude, and difficult to discern at the graphic resolution presented in Figure 27, but are clearly distinguishable in the RSMS raw data scans. The individual signal spectra are standard NTSC television broadcast, so these are multipoint distribution system (MDS, also called wireless cable television) transmitters.</p>
2700-2900 MHz	28	<p>All signals in this band are generated by high-power air-search radars. Four frequencies are easily discernable (2755, 2795, 2825, and 2880 MHz). Additional frequencies that are occupied by radars, as identified by the RSMS crew, are 2705, 2715, and 2855 MHz. Because automatic attenuation is not yet implemented in the RSMS, these radars saturate the RSMS front-end at their center frequencies during most of the measurements. However, a few manually attenuated scans were performed to document the peak received power, and are shown as the maximum curve. So, the average curve reflects the maximum, positive-peak detected amplitudes of the majority of scans (which were unattenuated), while the maximum curve shows the true envelope of radar emissions in this band. Note that the radar at 2795 MHz was tuned to about 2785 MHz on at least one (unattenuated) scan, resulting in the flat area on the maximum curve at that frequency. Radars in this band as measured by RSMS crew, typically have the following characteristics: mechanical rotation, no elevation scanning, 4.7-5.0 s rotation time, about 1-us pulse width, and about 1000 pulses/s emitted at a high-order stagger, presumably for Doppler processing of target returns.</p>
2900-3100 MHz	29	<p>High-power air-search radars are observed in this band. Compare the high levels of activity observed in San Diego to the nonexistent activity in Denver, Colorado [2].</p> <p>The high peak and average values recorded at 3050 MHz are generated by numerous surface-search radars used for maritime navigation. Most large vessels carry a surface-search radar that operates at or near 3050 MHz.</p>

Table 7. Comments on San Diego Spectrum Occupancy Measurement Results (Continued)

Spectral Range	Figure	Comments
3100-3700 MHz	30	Numerous high-power radars are observed in this band. Compare the high levels of activity observed in San Diego to the nonexistent activity in Denver, Colorado [2].
3700-4200 MHz	31	RSMS azimuth scans observe two fixed, point-to-point microwave links in this band. The spectra show that both of the links are digitally modulated.
4200-4400 MHz	32	Airborne radio altimeter signals, transmitted by aircraft on approach and departure from nearby airfields, are clearly observed between 4230-4370 MHz. Two modulations predominate: pulsed and FM/CW. Because the signals occur very intermittently, and some are pulsed, the average and minimum curves are not affected.
4400-5000 MHz	33	At least thirteen fixed, point-to-point microwave links are observed in this band, as measured with the RSMS azimuth-scanning technique. Narrow emission spectra are analog signals, and wide emission spectra are digital signals. Five of the thirteen identifiable signals are digital.
5000-5250 MHz	34	The signals observed in this band are spurious emissions from radars operating in the 5250-5925 MHz radiolocation band. Because they are pulsed emissions that occur sporadically, depending upon such factors as beam scanning, proximity of the observed radars to the RSMS, and operational times of the radars, the occupancy by the radar spurious emissions in this band looks “spiky” on the graph. (The optimal algorithm for observation of these signals would have been stepped, but the RSMS only uses that algorithm in radiolocation bands during spectrum surveys. This band was measured with the swept/m3 algorithm.) None of the signals in this band are microwave landing system (MLS) signals; there are no MLS deployed in the San Diego area.
5250-5925 MHz	35	All emissions in this band are produced by radars. Radars using this band include maritime surface-search and weather surveillance units. The flat plateaus in the maximum curve are caused by radar emissions that were measured when no personnel were present at the RSMS to invoke attenuation; automatic attenuation is being added to RSMS capabilities.
5925-7125 MHz	36	At least seven fixed links, all of them analog, are observed between 5925-6425 MHz, in a fixed and fixed-satellite band, in the RSMS azimuth-scan measurement. Another sixteen links, most of them analog, are observed between 6550-6875 MHz, in another fixed and fixed-satellite band. Four links, two of them digital, occur between 6875-7100 MHz in the fixed-satellite/auxiliary broadcasting band. Overall, less occupancy is observed from Point Loma by the RSMS than was recorded in Denver, Colorado [2].
7125-8500 MHz	37	Approximately seven fixed links, six of them analog, are observed in the RSMS azimuth-scan measurement. Substantially less occupancy is observed in this band in the RSMS San Diego survey than in the Denver survey [2].

Table 7. Comments on San Diego Spectrum Occupancy Measurement Results (Continued)

Spectral Range	Figure	Comments
8500-10550 MHz	38	<p>All signals observed in this band are generated by radars. The majority of radars observed in this band in San Diego are maritime surface-search units. Some airborne units are also observed. A shore-based navigation radar tuned to 9400 MHz was present in 100% of RSMS scans. Essentially all surface-search radars carried by small vessels operate in this band; larger vessels also frequently carry radars that operate in this band. Typical operational parameters of the surface search radars, as measured by RSMS crew, are: mechanical rotation, 2-4 s rotation, less than 300-ns pulse width, pulse repetition rates of several thousand pulses per second, no pulse staggering present.</p> <p>Compare occupancy in this band in San Diego to much lower occupancy in land-locked Denver, Colorado [2].</p>
10550-13250 MHz	39	One digital signal is observed in this band. Observed occupancy is lower than was observed in Denver, Colorado [2].
13250-14200 MHz	40	A radar is observed at 13730 MHz.
14200-15700 MHz	41	One or two signals are observed in the RSMS azimuth scan. In general, the probability of intercept by the RSMS for signals in this band is low. See Appendix C.
15700-17700 MHz	42	A few signals are observed in the RSMS azimuth scan. In general, the probability of intercept by the RSMS for signals in this band is low. See Appendix C.
17700-19700 MHz	43	No signals are observed; the change in the RSMS noise floor is due to a band edge in the spectrum analyzer. In general, the probability of intercept by the RSMS for signals in this band is low. See Appendix C.

4. REFERENCES

- [1] *Manual of Regulations and Procedures for Federal Radio Frequency Management*, revised Sep. 1993 and Jan. 1994, NTIA Office of Spectrum Management, U.S. Government Printing Office, Stock No. 903-008-00000-8.
- [2] F. H. Sanders and V. S. Lawrence, "Broadband spectrum survey at Denver, Colorado," NTIA Report 95-321, Sep. 1995.
- [3] *Title 47 Code of Federal Regulations, Telecommunications, Part 80 to End*, revised Oct. 1994, (U, S. Government Printing Office, Superintendent of Documents, Mailstop: SSOP, Washington, DC 20402-9328).
- [4] P.E. Gawthrop, F.H. Sanders, K.B. Nebbia, and J.J. Sell, " Radio spectrum measurements of individual microwave ovens," NTIA Report 94-303-1,2, Mar. 1994.

APPENDIX A: RADIO SPECTRUM MEASUREMENT SYSTEM (RSMS)

A.1 Introduction

The NTIA RSMS is a mobile, self-contained computer-controlled radio-receiving system capable of many measurement scenarios over a frequency range of 30 MHz to 22 GHz. This appendix contains specifications on the vehicle, instrumentation, and operation of the RSMS when it is deployed for broadband spectrum survey measurements.

A.2 Vehicle

For maximum effectiveness, the spectrum measurement system must be readily transported to near or distant locations that may not be easily accessible, e.g., open fields or hilltops without an access road. To meet this need, the measurement system, including antennas and support hardware, is carried in a shielded, insulated, climate-controlled shell mounted on a Chevrolet truck cab and chassis. The assembled measurement system and vehicle unit is called “the RSMS.” The vehicle has a high power-to-weight ratio, four-wheel drive, and a low-geared transmission for use on rough terrain and steep grades. The RSMS is still sufficiently small and light to fit on C-130 or larger aircraft for rapid transport over long distances. The chief disadvantage of a smaller unit is the loss of operating room inside the shell.

Figure A-1 shows the internal layout of the RSMS. Four full-height equipment racks are located transversely above the rear axle. These racks divide the box-like equipment compartment into two parts: one in front and one behind the racks. The forward area comprises the operator’s compartment with access to the equipment front panels, the main power panel and breaker box, work counters, two chairs, telephone, fax machine, and a cellular fax/modem. A built-in safe below the equipment racks provides storage for classified materials. A full-height cabinet in the forward driver’s side corner provides for storage of small, frequently used items. A compartment for the smaller of two telescoping masts is located behind this cabinet, and is accessed from outside the van.

Additional storage cabinets are available to the rear of the racks for larger and less-used items. Compartments for the large mast and the external-tap power cable and its electrically driven reel are located behind these cabinets, with outside access. The weight of the mast-rotator, power cable and reel is counterbalanced on the driver’s side by the 10-kW generator and two air conditioners. The rear area provides access to the back of the equipment racks. The generator compartment is accessed via an outside lift-up panel. The air conditioners are not readily accessible.

The tightly-shielded, windowless measurement compartment (shell) provides good radio frequency (RF) isolation between the measurement system and the outside environment. The small working compartment also reduces requirements for air conditioning and heating. Both of the telescoping masts are installed on rotators (at their bases) and will raise the antennas to a little over 8 m above ground.

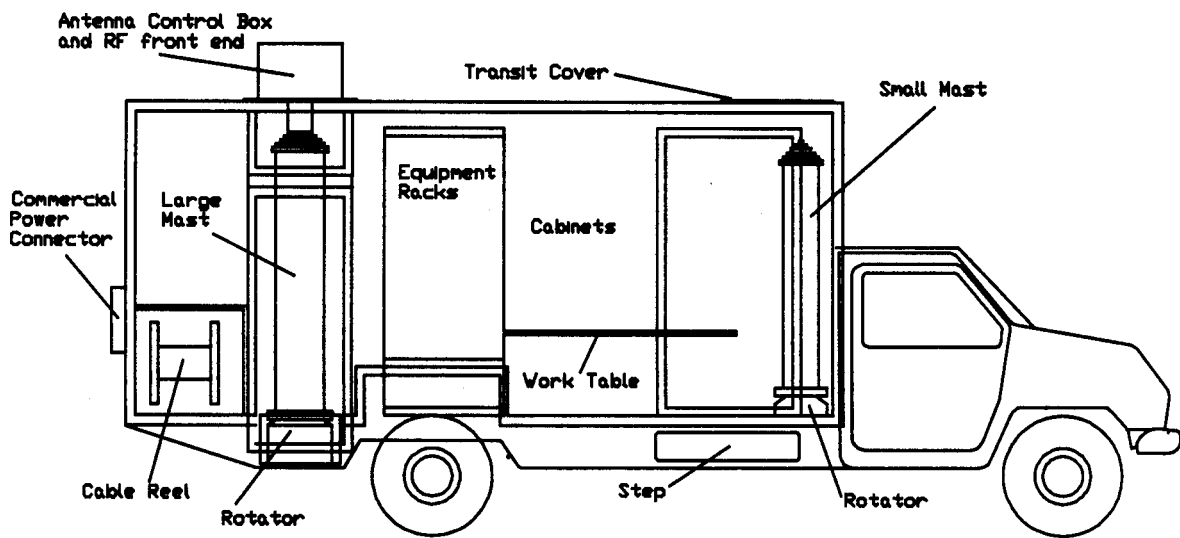
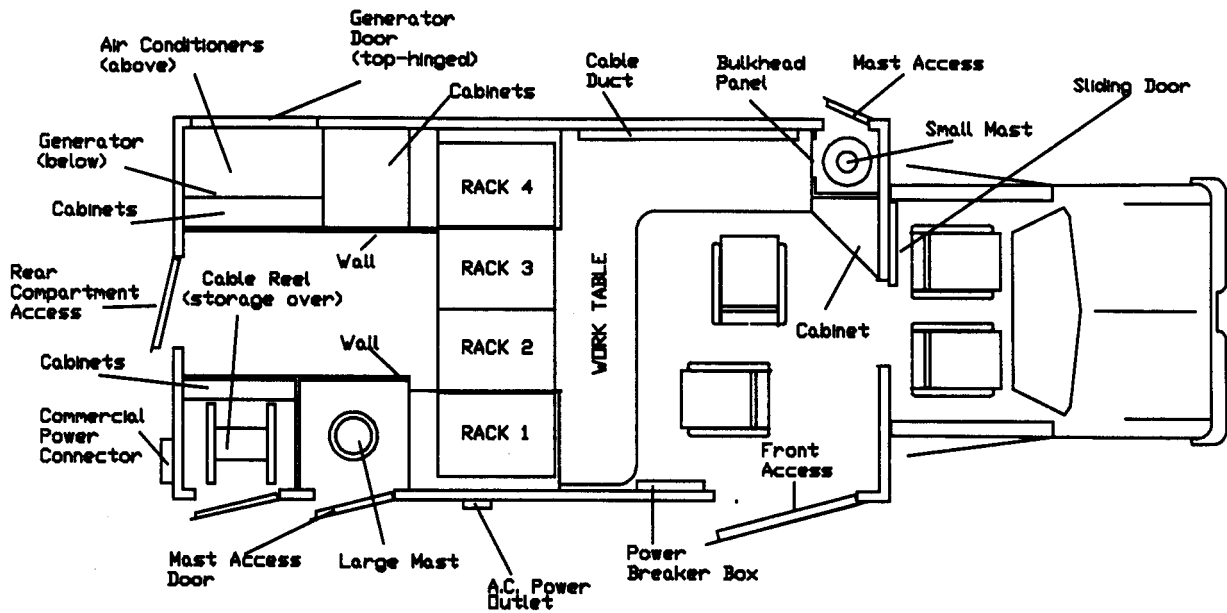

Figure A-1. Top and side view drawings of the RSMS.

A.3 Instrumentation

The RSMS is normally configured as two independent spectrum measurement systems, one optimized to measure lower frequency portions of the spectrum (System-1), and the other to measure higher frequencies (System-2) with some frequency overlap between the two systems. Figure A-2 is a fish-eye front panel view of the rack mounted instrumentation, Measurement and control instruments for System- 1 are in the two racks on the right of center, and for System-2, the two racks left of center. Both systems use RF front-ends that incorporate dynamic RF attenuation, low noise preamplification and tunable frequency preelection. These features allow the RSMS to achieve the best possible combination of dynamic range, sensitivity, and off-tuned signal rejection in its measurements.

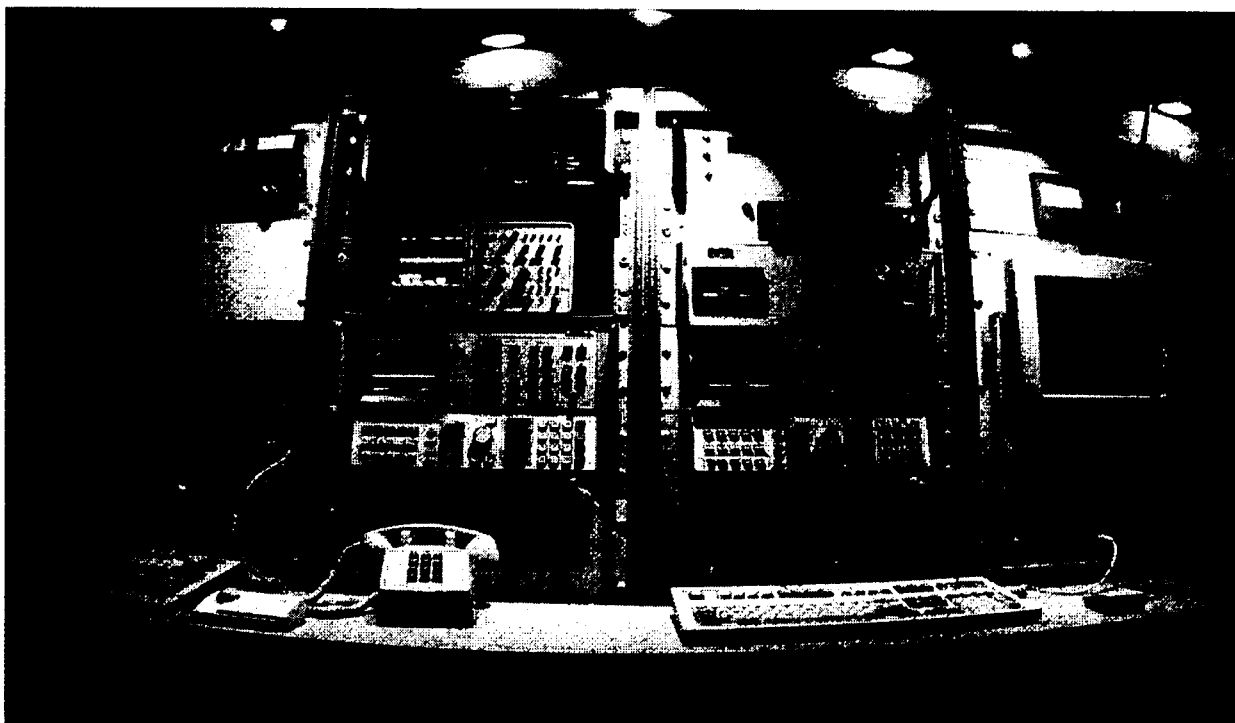

Figure A-2. Front panel of the RSMS instrument racks,

For spectrum surveys, the low-frequency system is usually operated between 100 MHz and 1 GHz, with its antenna(s) mounted on the smaller forward mast and its RF front-end located inside the operator's compartment. The high-frequency system is used for the remaining survey frequencies from 1-19.7 GHz, with its antenna(s) mounted on the larger mast and its RF front-end located at the top of that mast to overdrive the higher line losses that occur above 1 GHz. The RSMS receiver is depicted as a block diagram in Figure A-3. As the diagram shows, both the high and low frequency systems are designed around a 0-22 GHz range Hewlett-Packard 8566B spectrum analyzer, although the RSMS software will control other spectrum analyzers, such as the HP-70000 series. The selection of 1 GHz as the break point between the two systems in a site survey mode is determined primarily by the availability of antennas, which often begin or end their frequency response at 1 GHz.

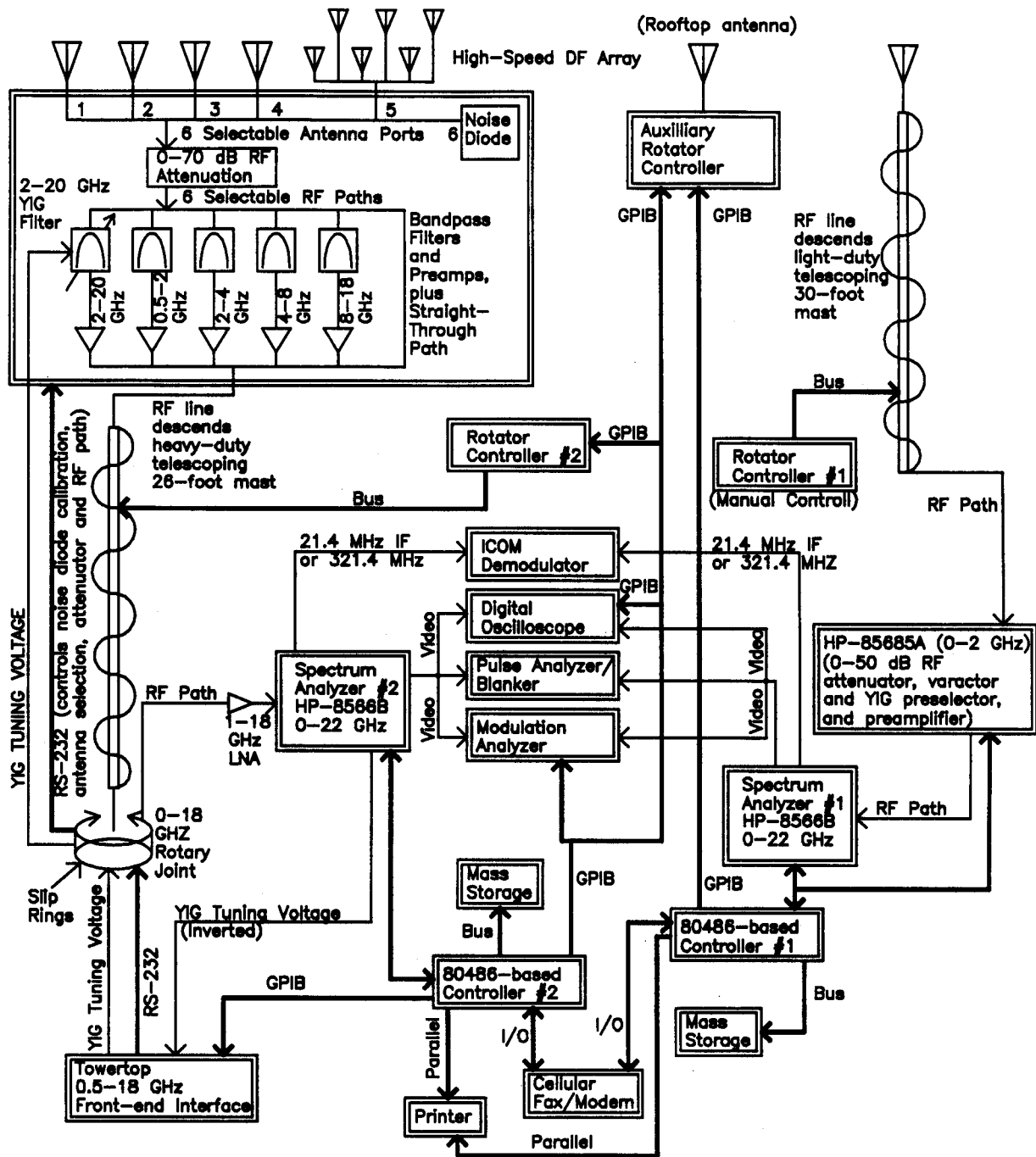

Figure A-3. Block diagram of the RSMS receiver.

Each of the measurement systems can be controlled in fully automatic, semiautomatic, and fully manual modes. In fully automatic operation, each system is controlled by ITS-written software (named DA, for Data Acquisition) that runs under Microsoft-DOS on 80486-based computers. Spectrum surveys are normally conducted in the fully automatic mode. RSMS operators are able to interrupt automatic measurements to perform work in semiautomatic and manual modes. These modes allow special measurements with varying degrees of automated assistance.

The two measurement systems utilize independent antennas, RF front-ends, masts, spectrum analyzers and computers, but share the use of auxiliary equipments for special measurements, analysis, and troubleshooting. Support equipments include a digital oscilloscope, pulse train analyzer, demodulator, modulation domain analyzer, rotator controllers, signal generators (frequencies range from a few kilohertz to 18 GHz), power supplies, low noise amplifiers, cables, connectors, and hand tools. Data from the oscilloscope can be downloaded to the controller computers. Data from the auxiliary devices are often used to determine specific characteristics of selected emitters during the course of a spectrum survey or other measurement.

The RF operational characteristics of the two measurement systems are shown as a function of frequency in Table A-1. The lower-frequency system can be operated across a frequency range of 100 Hz to 2 GHz, with fixed bandpass and varactor preselection at frequencies below 500 MHz and tracking yttrium-iron-garnet (YIG) preselection from 0.5-2 GHz. This system includes 0-50 dB of dynamically selectable RF attenuation in the front-end, and achieves a typical overall noise figure of 10 dB across its entire frequency range. The higher-frequency system can be operated across the 0.5-22 GHz range, with YIG preselection from 2-20 GHz. This system incorporates 0-70 dB of dynamically selectable RF attenuation in the front-end, and uses low noise preamplifiers to achieve a typical noise figure of 10-15 dB up to about 10 GHz, and a noise figure that increases from 15-25 dB at frequencies from 10-20 GHz. Better noise figures can be obtained by using the fixed bandpass filters for preselection instead of the YIG, but that arrangement is tenable only if there are no in-band signals strong enough to overload the preamplifiers.

A.4 Antennas

The RSMS normally carries a complement of broadband antennas that cover a 0.1-20 GHz frequency range. Other antennas necessary for measurements at higher or lower frequencies are stored at the ITS laboratory. Omnidirectional, slant-polarized biconical antennas are most frequently used for site surveys. These antennas provide a good response to circular, vertical, and horizontal signal polarizations. At frequencies from 0.1-1 GHz, a slant-polarized log periodic antenna (LPA) may be used if (as in the San Diego survey) most of the radio activity in the area is confined to an area subtending 180° or less relative to the RSMS and a satisfactory omni antenna is not available. Besides the 0.1-1 GHz LPA, the following omnidirectional slant-polarized biconical antennas are also carried: 0.5-20 GHz, 1-12 GHz, 2-8 GHz, and 8-20 GHz.

In addition to the LPA and omnidirectional antennas, a variety of broadband cavity-backed spiral (CBS) antennas are carried. These have antenna patterns that are most useful for direction-finding using differential methods at relative observation angles of 60° or 90°. They are also

Table A-1. Available RSMS RF Signal-processing Paths

Frequency Range	RSMS System	Dynamic RF Atten. (dB)	Type of Preselection and Low-noise Preamplification	Noise Fig.* (dB)
100 Hz - 2 MHz**	1	0-50	Fixed Bandpass; HP-85685A preamps ⁺	10
2 MHz - 20 MHz**	1	0-50	5% Varactor; HP-85685A preamps ⁺	10
20 MHz - 100 MHz**	1	0-50	5% Varactor; HP-85685A preamps	10
100 MHz - 500 MHz	1	0-50	5% Varactor; HP-85685A preamps	10
500 MHz - 2 GHz	1	0-50	0.2% Tracking YIG; HP-85685A preamps	10
500 MHz - 2 GHz	2	0-70	Fixed Bandpass; 0.5-2 GHz preamp [±]	10
2 GHz - 4 GHz	2	0-70	Fixed Bandpass; 2-4 GHz preamp [±]	10
4 GHz - 8 GHz	2	0-70	Fixed Bandpass; 4-8 GHz preamp [±]	10-15
8 GHz - 18 GHz	2	0-70	Fixed Bandpass; 8-18 GHz preamp [±]	15-25
2 GHz - 20 GHz	2	0-70	0.2% Tracking YIG; 1-20 GHz preamp [±]	15-25

* Noise figure is measured using a +25 dB ENR noise diode and Y-factor calibration. Calibration is performed at the antenna terminals.

** Due to the shortage of storage space for large antennas, this frequency range is not normally measured as part of an RSMS spectrum survey.

+ The low-frequency input on the HP-85685A preselector must be used.

± Generally, this path is only used to perform azimuth-scans or special measurements during an RSMS spectrum survey, but may be used for normal survey bands if no high-amplitude signals are anticipated in the measured frequency range.

≤ This path is normally used for all spectrum survey bands (except azimuth-scans, see note ± above) in the 1-19.7 GHz frequency range. The YIG and preamplifier nominally operate in the 2-18 GHz frequency range, but have demonstrated adequate performance across a 1-20 GHz range.

useful as auxiliary antennas for manual monitoring of emitters or spectrum of special interest and for use on side excursions to measure specific emitters of interest in the area of a site survey. The frequency ranges of these CBS antennas are 1-12 GHz, 8-18 GHz, and 400 MHz-2 GHz. The latter is not normally carried due to its size.

A 1-m parabolic dish antenna with a linear cross-polarized feed of 2-18 GHz is normally carried. This antenna may be used to perform azimuth-scanning measurements in the common carrier (point-to-point microwave) bands, but is primarily used for measurements on specific emitters (e.g., selected radars).

The receiving antennas are the only components of the RSMS that are not calibrated in the field. Because most RSMS measurements are performed to acquire relative emission levels, rather than absolute incident field strength values, the main requirement for RSMS antennas is that they have a fairly flat gain response as a function of measured frequency. If absolute incident field strengths must be known for received signals, then the gain factors (or, equivalently, the antenna correction factors) for the applicable antennas are determined from manufacturer-generated tables and curves, and the RSMS measurements are corrected in a post-acquisition analysis phase.

A.5 Attenuators, Preselectors, and Preamplifiers

All RSMS measurements are made using the RF front-ends depicted in Figure A-3. These front-ends incorporate dynamically switched RF attenuation, preelection, and preamplification. The Hewlett-Packard 85685A is used for frequencies below 2 GHz, and a unit designed and fabricated by ITS is used at frequencies between 2 and 20 GHz. The two boxes (HP 85685A and ITS designed unit) are functionally similar, but differ in significant details. For example, the 85685A provides 0-50 dB of RF attenuation, and the ITS box provides 0-70 dB of RF attenuation. This active attenuation allows the total dynamic range of the RSMS to be extended to as much as 130 dB.

Effective bandpass preelection is required if low noise preamplifiers (LNAs) are used; this is the case for essentially all RSMS measurements. Preelection prevents strong off-tuned signals from overloading the front-end LNAs. At frequencies below 500 MHz, preelection in the HP-85685A is provided by fixed filtering, up to 2 MHz, and by 5% tracking varactors from 2-500 MHz. Tracking YIG filters are used in the frequency ranges of 500 MHz to 2 GHz and 2 GHz to 20 GHz. YIG filters provide the narrowest preelection (15 MHz wide at 500 MHz to about 25 MHz wide at 20 GHz), but at a cost of about 6 dB of insertion loss. Using fixed bandpass filters can reduce the preelection insertion loss to about 1 dB; fixed bandpass filters in an approximately octave progression are available in the ITS front-end (see Figure A-3). These can only be used if no signals are present in the band which are strong enough to overload the LNAs.

LNAs are used to achieve the best possible sensitivity, coupled with (ideally) just enough gain to overdrive the noise figure of the rest of the measurement system. Operationally, at frequencies below 1 GHz, line losses are sufficiently low to allow placement of the RF front-end inside the operator's compartment with an RF line to the antenna mounted on the mast. At frequencies above 1 GHz, however, the line loss is 10 dB or more, and thus the LNAs (and the rest of the RF front-end) must be positioned at the top of the mast. (Consequently, the mast must be sturdier than the lower-frequency system mast.) If a single LNA at the top of the mast were used, it would have to overdrive at least 41 dB of signal loss (6 dB of insertion loss, 10 dB of RF line loss, and at least 25 dB of spectrum analyzer noise figure). Thus, to achieve an overall noise figure of 10 dB, a single LNA would have to have a noise figure of about 8 dB, and a gain of at least 33 dB. Because LNAs to accomplish this are not available, low noise preamplification is provided by cascaded preamplifiers located at two points in the high-frequency system: one at the top of the mast (overdriving YIG insertion loss, mast line loss, and the 4-dB noise figure

of the second LNA) and one at the input to the spectrum analyzer (to overdrive the analyzer noise figure).

A.6 Calibration

RSMS calibrations are performed with noise diodes and a Y-factor excess noise ratio (ENR) technique described in detail in Appendix D. Typically, a noise diode ENR source is used to calibrate an entire signal path for measurements about to be performed. Resultant frequency-dependent noise figure and gain calibration curves are used to automatically correct the measured amplitudes of all received signals. This calibration technique has proven very successful for field-deployed systems. It is a fast way to determine sensitivity and gain-correction values for a measurement system, and it is also very useful for isolating the gain and loss factors of individual system components.

A.7 Additional Measurement Capabilities

When deployed for general spectrum occupancy measurements (broadband spectrum surveys), the RSMS is also equipped to perform other measurements. Following are brief descriptions of other measurement capabilities currently available.

Extended Emission Spectra: Measurements of radiated and in-guide emission spectra of individual radio transmitters, particularly radars, are a major strength of the RSMS program. A combination of high sensitivity and interactive front-end RF attenuation make it possible to routinely measure the emission spectra of radio emitters across several gigahertz of spectrum. Specialized RSMS measurement techniques and algorithms support spectrum measurements of intermittently received emitters, such as scanning radars, without the need to interrupt or interfere with their operations. The RSMS uses a stepped measurement routine that allows for measurements that are faster, have more dynamic range, and are more repeatable than swept measurements. Accurately tracked YIG and varactor-tuned preselection make stepped measurements highly resistant to problems of overload from strong center-frequency signals while measuring low-amplitude emissions in adjacent parts of the spectrum.

Azimuth Scan: This special measurement routine is used to determine the receivability of selected signals at particular locations, even if those signals propagate via unconventional (nonline-of-sight) routes. The RSMS parabolic dish antenna is rotated through 360° on the horizon while recording received signal strength. This results in data showing the receivability of signals at all azimuths, and reveals nonline-of-sight propagation routes, if any exist. Azimuth scanning may be used to support spectrum surveys.

Transmitter Equipment Characteristics: The RSMS is capable of measuring and recording signal characteristics of multiple transmitter types. As part of any measurement scenario, certain received signals may be singled out for monitoring and detailed analysis. These special measurements may be used to determine radiated emission characteristics of known transmitters or identify the source of unknown transmissions. Measured transmitter (signal) characteristics

include: tuned frequency or frequencies, beam-scanning method (regular rotation, sector scan, etc.), beam scan interval, radiated antenna pattern, modulation type (AM, chirped, etc.), pulse width, pulse repetition rate, pulse jitter, pulse stagger, and intrapulse modulation. Although the RSMS can observe the presence of phase coding in pulsed signals, no phase measurement capability is explicitly included in RSMS capabilities.

APPENDIX B: DATA ACQUISITION SOFTWARE

B.1 Introduction

The RSMS is designed to identify and characterize spectrum usage at certain frequencies or in selected bands, and to perform in-depth analysis of factors such as system compatibilities with each other or with spectrum assignments. Because of the diverse signal types encountered when measuring an extended spectrum, the measurement system must be able to detect all or at least most of the signals and to display or record as much information about them as possible. Obviously, a general-purpose measurement system cannot receive every signal type; however, the RSMS receiver detects almost every signal type encountered. As shown in Appendix A, the RSMS hardware can be configured as a receiver for practically all signal types occurring within an extended frequency range spanning 100 Hz to 19.7 GHz.

The key to efficient use of this extended measurement capability is rapid reconfiguration. The RSMS uses software developed by ITS to control all measurement system functions via computer. This control program, called "DA" (for Data Acquisition), runs on any DOS-based computer with sufficient memory. It interfaces via general-purpose interface bus (GPIB) with the measurement system at rates limited only by the computer's operating speed and functional speed of the managed hardware (interfaces, switches, components, etc.). DA will support many combinations of RF front-ends, spectrum analyzers, and auxiliary analysis equipment. DA also controls noise diode calibration of the RSMS and characterizes the noise figure and gain for individual components and entire measurement signal paths.

The DA program is basically four control subroutines that direct operation of multiple subroutine kernels that in turn control every function of the measurement system. This appendix includes descriptions of the four control subroutines (receiver algorithm, spectrum analyzer, RF front-end, and calibration) and the resultant system functions. As DA program development continues to meet new measurement demands, these functional descriptions may change with time.

B.2 Receiver Algorithm Subroutine

The DA receiver algorithm subroutine provides software management for up to 32 measurement algorithms (called band events for RSMS operations; see Section 2.3.1). Any one of these algorithms, when coupled with spectrum analyzer and front-end selections (described later in this appendix), becomes a customized measurement system for receiving certain signals or signal types. Because the characteristics of emitters and the requirements for data on those emitters vary considerably, many different algorithms have been developed. However, all of the algorithms are based upon either a frequency sweep across the spectrum of interest, or a series of discrete steps across that spectrum.

For spectrum surveys, sweeping algorithms are generally used to examine spectral bands occupied by high duty cycle emitters such as mobile radios and television transmitters, and stepping algorithms are used to monitor spectral bands occupied by low duty cycle emitters such as

radiolocation equipments (radars). Following are brief descriptions of the algorithms used during a spectrum survey.

Swept: This algorithm controls a conventional spectrum analyzer¹ sweep across a selected portion of spectrum. Any type of detection available in the analyzer (i.e., positive peak, sample, etc.) can be used. Repeated sweeps may be programmed, and multiple sweeps incorporating the maximum-hold spectrum analyzer mode may also be performed. This algorithm also allows for sweeping a spectral band in several sub-bands (scans). This feature is important if a narrow bandwidth (e.g., 10 kHz) must be used to measure a spectral band that is more than 1000 times the width of the measurement bandwidth, e.g., measuring 900-930 MHz with a 10-kHz bandwidth requires at least three scans to ensure no loss of data.

Swept/m3: This is a swept measurement (as described above) that produces three data traces across a measurement range. At each of the 1000 frequencies measured on each individual spectrum analyzer sweep, the maximum, minimum, and (log) mean received signal levels are measured. Repeated sweeps are made across the spectrum of interest, and for each of the measurement points returned from each sweep, the three registers for current maximum, minimum and mean are updated. This process continues until it is halted programmatically. The total amount of time for each sweep, and the total number of sweeps to be performed, are specified in advance by the operator. The duration of each individual sweep maybe a few milliseconds, with a typical Swept/m3 measurement (hundreds of sweeps) lasting a total of several minutes. These cumulative three-trace Swept/m3 measurements are saved on magnetic media, and may themselves be cumed (see Section 3.3) in the analysis phase of a site survey to yield long-term Swept/m3 curves. Typical RSMS site surveys use Swept/m3 measurements for mobile radio bands.

Stepped: Stepping measurements consist of a series of individual amplitude measurements made at predetermined (fixed-tuned) frequencies across a spectrum band of interest. The measurement system remains tuned to each frequency for a specified measurement interval, This interval is called step-time, or dwell. The frequency interval for each step is specified by an operator, and is usually about equal to the IF bandwidth of the measurement system. For example, measurements across 200 MHz might use 200 steps at a 1-MHz step interval and a 1-MHz IF bandwidth. Computer control of the measurement system is needed for this (step, tune, and measure) process to be performed at maximum speed.

Stepped measurements are usually performed to capture peak signals occurring on an intermittent basis. A prime example is a periodically scanning radar. If the step-time (dwell) is set slightly longer than the rotation or scanning interval of the radar beam, then the maximum receivable level from the beam will illuminate the RSMS at some

¹For most RSMS operations with DA software control, any GPIB-interfaced spectrum analyzer that processes at least 1000 points (frequencies) per display sweep may be used.

time during that interval. The RSMS, which is fixed-tuned for the entire dwell period, records each peak-detected point during that interval and the maximum amplitude recorded is saved for that frequency. The RSMS then tunes to the next frequency (one step), and repeats the process until the entire specified spectrum has been measured.

For intermittently received signals, such as scanned-beam radars, the stepped algorithm has advantages over swept measurements. Stepping is faster, allows more dynamic range (attenuation can be added and subtracted as a function of measured frequency to extend the total available dynamic range of the measurement system), and has better repeatability than swept measurements.

The RSMS uses stepped measurements to gather data in radiolocation bands where measurements can be tailored to transmitter characteristics; i.e., dwell times, IF bandwidths, step widths, etc. are determined as a function of the parameters of the radiolocation equipments which normally operate in the band.

Swept/az-scan: This is *not* currently a selectable algorithm in DA, but is a hybrid routine using the Swept algorithm (above) with a rotating dish antenna. The dish is targeted on the horizon then rotated 360° while the Swept algorithm is running with positive peak detection and Maximum-Hold screen mode on the spectrum analyzer. The result is an analyzer display that shows the maximum activity across a band in an omnidirectional receiver sense, but with the effective gain of a dish antenna. This routine is most useful for nondynamic bands where received signal levels tend to be weak. Good examples are the common carrier (point-to-point) microwave bands; their transmitters are fixed-tuned, operate continuously, and do not move. The transmitters are also low-powered, and use high-gain antennas which further reduce their probability of intercept.

B.2.1 Receiver Parameters

Following are brief descriptions of the DA program input parameters needed to run the above subroutines (algorithms). Brackets identify the corresponding column headings as they appear in the band event tables of Section 2.3.1. For example, [algorithm] in the tables shows which of the above described subroutines is controlling the band event.

Start and Stop Frequencies [start (MHz)] [end (MHz)]: The value in megahertz of the first and last frequency point to be measured. These numbers must be equal to or fall outside the event frequency band range.

Passes: The number of times the algorithm iterates for each run command. This value is always one for spectrum surveys.

Scans [scans (# of)]: The number of measurement sub-bands to occur between the start and stop frequencies. This value is usually determined by comparing measurement bandwidth and frequency range. For example, a 30-MHz frequency range

measured with a 100-kHz IF bandwidth would ensure sampling of all frequencies (1001 points) in *one scan*. However, if a 10-kHz IF bandwidth were used in the above example, three *scans* would be required to ensure sampling of all frequencies.

Sweeps [sweeps (# of)]: The number of sweeps in each scan. DA processes each sweep so increasing this number can add greatly to measurement time; however, increasing this value also increases the probability of intercept for intermittent signals.

Steps [steps (# of)]: The number of frequency steps to occur between the start and stop frequencies. This parameter is only used with stepped algorithms.

Graph Min and Graph Max: The minimum and maximum values in dBm for the graphical display of measured amplitude data.

B.3 Spectrum Analyzer Subroutine

The DA spectrum analyzer subroutine manages configuration control strings (via GPIB) for the spectrum analyzer. The operator selects spectrum analyzer parameters (listed in the following subsection) from menus in the DA program. Generally, parameters are selected that will configure the analyzer to run with a receiver algorithm for a desired measurement scenario. The software protects against out-of-range and nonlinear configurations but the operator can control the analyzer manually for unusual situations.

B.3.1 Spectrum Analyzer Parameters

When the DA program sends command strings to the analyzer, all signal path parameters are reset according to the operator selections for the measurement scenario. Following are brief descriptions of the analyzer parameter choices controlled by DA. Brackets identify the corresponding column headings as they appear in the band event tables in Section 2.3.1.

Attenuation: May be adjusted from 0-70 dB in 10-dB increments. The spectrum analyzer subroutine determines whether or not RSMS front-end attenuators are available and if so will set them to the selected value. Spectrum analyzer attenuation is set to zero when RSMS attenuation is active; if however, RSMS attenuators are not available, the spectrum analyzer attenuation will be set to the selected value,

IF Bandwidth [IFBW (kHz)]: May be selected from 0.01-3000 kHz in a 1, 3, 10 progression.

Detector [detector type]:+,- peak, positive peak, negative peak, sample, maximum hold, and video average modes are available. See Appendix C for discussions on detector selection for receiver algorithms.

Video Bandwidth [VBW (kHz)]: Maybe selected from 0.01-3000 kHz in a 1, 3, 10 progression.

Display: Amplitude graticule choices in dB/division are: 1, 2, 5, and 10. This parameter selection applies to both the analyzer and the system console displays.

Reference Level [RL (dBm)]: May be adjusted from -10 to -70 dBm in 10-dB increments.

Sweeps [MH/VA (#swps)]: Number of analyzer-processed sweeps per scan. This parameter is only used with maximum hold or video-averaged detection.

Sweep Time [swp/stp (see)]: This parameter (entered in seconds) specifies sweep (trace) time if used with swept algorithms, or specifies step time (dwell) if used with a stepped algorithm.

B.4 RF Front-end Subroutine

The DA software handles the RF front-end path selection differently than other routines. Most of the RF-path parameters are predetermined by the measurement algorithm so operators need only select an antenna and choose whether preamplifiers are turned on or off. Preelection is also controlled by the antenna selection.

The antenna selection is made from a list of antenna choices that is stored in a separately maintained library file called by the RF Front-end Subroutine. Antenna information stored in the file includes:

- ▶ antenna type (omni, cavity-backed, etc.);
- ▶ manufacturer (may include identification or model number);
- ▶ port (tells the computer where signals enter the RSMS and includes particulars on any external signal conditioning such as special mounting, additional amplifiers, or extra path gain or loss);
- ▶ frequency range;
- ▶ vertical and horizontal beam widths;
- ▶ gain relative to an isotropic antenna;
- ▶ front to back gain ratio; and
- ▶ side lobe gain levels.

B.5 Calibration Subroutine

The calibration subroutine may be run at any time the operator chooses, but measurements must be interrupted. The software is interactive and flexible, allowing the operator to choose any calibration path desired. RSMS calibrations are performed with noise diodes and Y-factor excess noise ratio (ENR) techniques, as described in Appendix D.

APPENDIX C: INTERPRETATION OF SPECTRUM SURVEY DATA

C.1 Introduction

RSMS spectrum survey measurements are performed with a variety of receiver algorithms (see Section B.2 of Appendix B). These algorithms provide various combinations of frequency-sweeping or frequency-stepping, positive-peak or sample detection, and data-processing capabilities during the data acquisition phase of the spectrum survey. Additional processing is performed on the data after the acquisition phase. Measurement algorithms are assigned on an individual basis to optimally measure spectrum use in each band.

Each algorithm has a particular response to noise and signal activity. It is critical to understand the noise and signal response of each algorithm if the RSMS data are to be used accurately. This appendix describes the algorithms currently used for RSMS site surveys. The noise and signal response of each algorithm is described, along with the types of spectrum occupancy it is best suited to measure. Some of the data-processing techniques are also discussed to fully explain the measurement algorithms.

C.2 Signal Probability of Intercept Factors

RSMS measurements are intended to achieve a high probability of intercept for the types of signal activity occurring in each spectral band. Factors that are considered include:

- ▶ the types of emitters allocated to the band (e.g., land mobile radio, radiolocation, or broadcasting);
- ▶ the percentage of time individual transmitters in the band typically operate (e.g., 100% on-air time by broadcasters vs. intermittent radio dispatch messages);
- ▶ the dependence (or nondependence) of band activity on diurnal and other cyclic occurrences (e.g., radionavigation beacons with no time dependence vs. marine mobile activity which varies as a function of time-of-day and day-of-week);
- ▶ the time interval that individual transmissions usually occupy (e.g., air traffic control communications vs. cellular telephone communications);
- ▶ the periodicity, if any, of individual transmissions (e.g., a highly periodic search radar beam that completes a rotation every 4 s vs. mobile communications that occur in a random distribution over time);
- ▶ the directional gain, if any, of antennas used by the transmitters (e.g., an omnidirectional navigation beacon vs. a point-to-point microwave link);

- ▶ the typical peak and average power outputs of transmitters in the band (e.g, 4 MW peak power from a radar vs. perhaps a fraction of a watt from a typical land mobile radio);
- ▶ the signal duty cycle (e.g., a 30-dB duty cycle for a typical radar vs. a near 0-dB duty cycle for a two-way radio transmission);
- ▶ the relative abundance or paucity of systems using the band (e.g., a band used largely by airborne fire-control radars vs. a band used by thousands of local voice-communication radios); and
- ▶ the polarization of typical transmitted signals in the band.

These factors are used to optimize the receiver parameters for the selected band, select the measurement algorithm, and determine how measurement time should be allocated. The relative amount of time devoted to measure each band is roughly proportional to the dynamics of band usage. For example, point-to-point microwave bands are not very dynamic, because the transmitters in these bands normally operate 24 hours/day, 365 days/year, at uniform power levels, and fixed beam directions. Their operations are not normally affected by external factors, such as weather or local emergencies. Consequently, these bands are measured only once during a spectrum survey. In contrast, activity in land mobile radio bands is highly dynamic, varying significantly with time-of-day, day-of-week, and other factors such as local emergency conditions. Consequently, these bands are measured frequently throughout a site survey, so that a maximal number of time-dependent signals will be intercepted. Slightly less dynamic bands, such as those used by tactical radars, are measured less frequently than the mobile bands, but more frequently than the point-to-point microwave bands. Bands whose use varies with local weather, such as those used by weather radars, are measured on different clear-weather and foul-weather schedules.

Swept-spectrum measurement techniques are used in highly dynamic bands. Stepped-spectrum techniques are used in bands occupied by periodic emitters, such as radars. A slow dish antenna sweep of the horizon coupled with simultaneous swept-spectrum measurements is used in point-to-point microwave bands. These measurement techniques are detailed in the following subsections.

A parabolic antenna is used to measure signals from fixed-beam, highly directional transmitters in the point-to-point microwave bands (see the description of azimuth scanning in Section C.8). For bands in which signals are expected to originate primarily from a single quadrant as seen from the RSMS location, a moderately directional antenna (such as a cavity-backed spiral or a log-periodic antenna) is used. For bands in which signals are expected to originate from any direction with an approximately constant probability, such as bands used by airborne beacon transponders and air-search radars, the RSMS uses omnidirectional antennas.

Slant (antenna) polarization is used for all RSMS measurements except those in the point-to-point microwave bands. Slant-polarized biconical omnidirectional antennas are usually used above 1 GHz, and slant-oriented log-periodic or conical omnidirectional antennas are usually used below

1 GHz. Slant polarization provides adequate response to all signals except those having a slant direction orthogonal to the RSMS antennas. Orthogonally oriented slant-polarized signals are rare. In the point-to-point microwave bands, the transmitted signals are always vertically or horizontally polarized, and thus RSMS receive polarization in those bands is alternately vertical and horizontal, with the results being combined into a composite scan.

The end result of these selections (number of measurements made in each band, selection of antenna type and polarization, and selection of measurement algorithm) is to optimize the probability of intercept for signals present during the course of the RSMS site survey. Inevitably, some signals will be missed; however, the standard RSMS spectrum survey data set should provide a good measure of the relative number, levels, and types of signals in each of the bands between 100 MHz and 19.7 GHz.

C.3 Overview of Swept Measurement Techniques

To fully understand the measurement algorithms described in this appendix, it is necessary to describe how the spectrum analyzers perform swept-frequency measurements.

The HP-8566B spectrum analyzers used in the RSMS sweep across the spectrum in individual segments called spans. The frequency range of each span is in turn broken into 1001 individual frequency bins. When the spectrum analyzers perform sweeps across a selected span, they spend a finite amount of time measuring received power in each of the 1001 bins. For example, a 20-ms sweep time divided by 1001 measurement bins per sweep yields a 20- μ s measurement time in each frequency bin. Within each bin measurement interval (in this example, 20 μ s), the power measured in the waveform may take on multiple values. However, the spectrum analyzer can only provide a single power measurement per bin.

The single value derived from the multiple values occurring within each bin-sampling interval depends upon which spectrum analyzer detector mode has been selected. The detector modes available in the RSMS spectrum analyzers are positive peak, negative peak, sample, and "normal." (Note: positive peak detection is different from the maximum-hold display mode discussed in Section C.6.) Positive peak detector mode will latch to the highest power value attained by the measured waveform during the sampling interval (continuing the example above, this would be 20 μ s) for each bin. Similarly, the negative peak detector mode latches to and displays the lowest power level measured during each bin interval. In sample detector mode, the value displayed is the power level that the input waveform has assumed at the end of the bin measurement interval. If the bin sampling interval is uncorrelated with respect to the input waveform, then this value can be considered to be randomly selected from the input waveform. Finally, in "normal" detection mode, alternate bins use positive peak and negative peak detection,

If the analyzer's video bandwidth is substantially narrower than the IF bandwidth, and if a white noise source (such as thermal electron noise in a circuit or a noise diode) is being measured, then an average value of the noise will be displayed, irrespective of the detector mode which has been selected.

If the analyzer's video bandwidth is equal to or greater than the IF bandwidth, and if a white noise source is being measured, then the displayed power level will vary as a function of the detector mode. Positive peak detection will display noise values approximately 10-12 dB higher than the RMS noise level, and negative peak will display values about 10-20 dB below the RMS noise level. "Normal" detection used on such a noise source will display an illuminated band about 20-30 dB wide, with an average value equal to the RMS level of the noise. Normal detection mode is useful for estimating the duty cycle of a signal (the wider the illuminated band underneath a signal peak, the lower the duty cycle of the signal).

C.3.1 Description of the Swept/m3 Measurement Algorithm

The Swept/m3 algorithm, developed by ITS, is an extension to the swept measurements just described. In Swept/m3 mode, frequency-domain data traces are measured repeatedly across a band on the spectrum analyzer. Each sweep is returned individually to the PC controller, but the data traces are not individually recorded. Instead, for each of the 1001 frequency bins that the analyzer returns in each sweep, the PC sorts the returned values as follows: the value in each bin is compared to the highest and lowest values so far observed in that bin, and if the new value represents a new maximum or minimum in that bin, then it is saved as such. (This is, in effect, a software-implemented version of maximum-hold and minimum-hold trace mode.) Also, the current value of each bin is included in a running average of all the values returned for that bin in previous sweeps. This is an average of measured power in the selected detector mode (i.e., the decibel values are averaged). Thus, the maximum, minimum, and mean (m3) signal levels in a band are simultaneously obtained over the time interval (typically several minutes) that the spectrum analyzer continues sweeping. This real-time turning process compresses data volume by several orders of magnitude, but the compression causes loss of the original data sweeps, and thus precludes the possibility of processing the original data sweeps with different algorithms during postmeasurement analysis. Figure C-1 shows how the Swept/m3 cumulative processing is integrated with the normal RSMS processing path. All other cumulative processing is accomplished during postmeasurement analysis.¹ In the diagram, all measured data identified as "RSMS data output for lab analysis" is considered to be postmeasurement data.

C.4 Description of Swept/m3/Sample Data Collection

If the Swept/m3 algorithm (described in Subsection C.3. 1) is performed using the sample detector (see Section C.3 for a description of the sample detector in the RSMS analyzers), then the data are referred to as "Swept/m3/sample,"

¹All band events measured more than once during the same survey are cumed as explained in this appendix. Stepped and swept data records are processed for maximum, mean, and minimum received signal levels. Swept/m3 data already contains this information so a maximum of maximums, mean of means, and minimum of minimums is extracted for survey graphs.

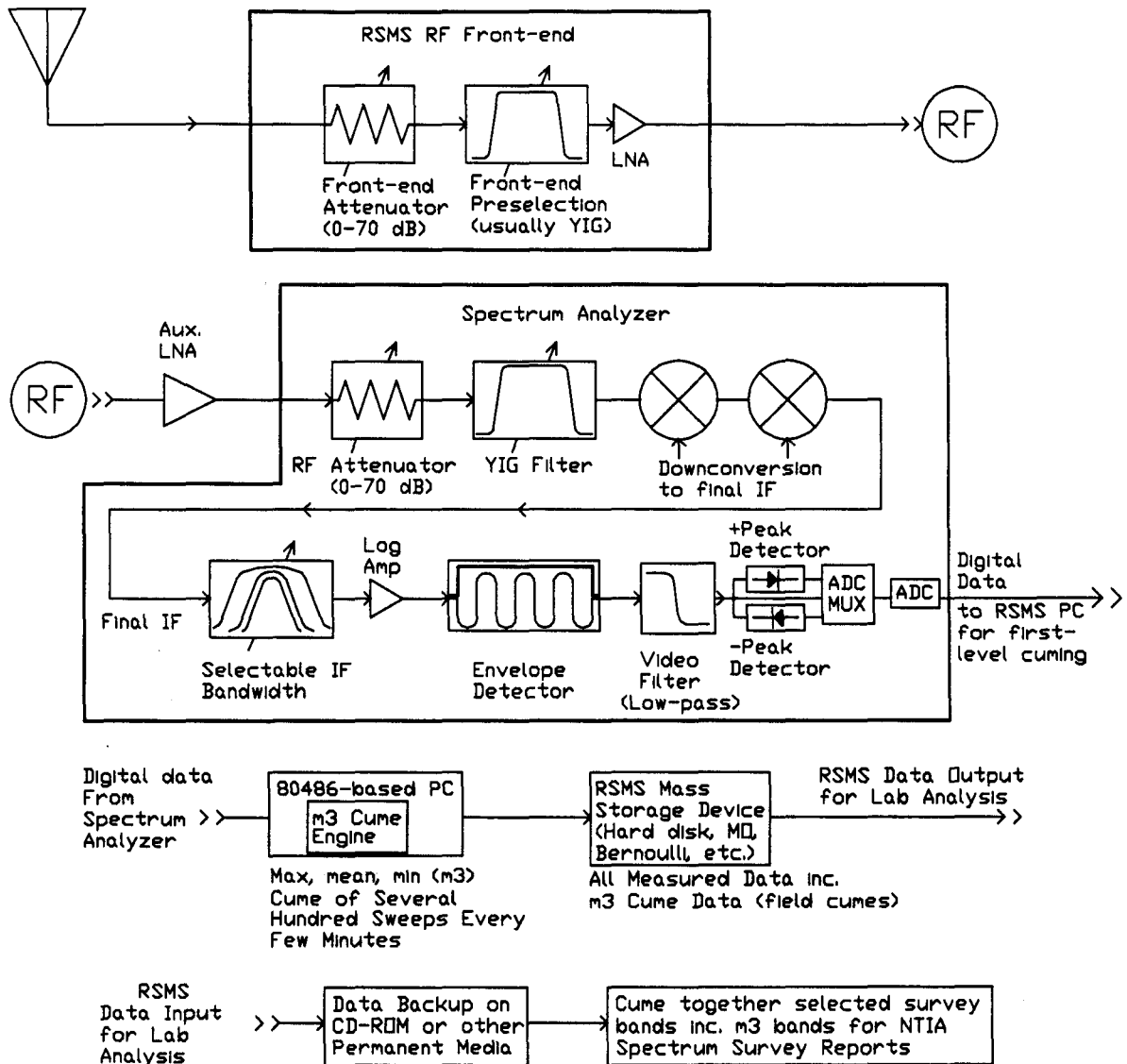

Figure C-1. Functional diagram of the RSMS signal-processing path for cumulated data.

C.4.1 Interpretation of Noise Responses in Swept/m3/SampIeData

The noise level displayed by a measurement system using the sample detector will be equal to $[kTB + (\text{measurement system noise figure}) - 2.5\text{dB}]^2$.² With a 1-MHz IF bandwidth and a 10-dB measurement system noise figure, for example, the average noise level would occur at -104 dBm.

² kTB is derived from the Nyquist Theorem for electron thermal noise, where: k is Boltzmann's constant ($1.38 \cdot 10^{-20}$ mW*s/K), T is system temperature (290K for these measurements), and B is measurement IF bandwidth in Hz. For $B = 1$ Hz, at room temperature: $kTB = -174$ dBm. In a 1-MHz IF bandwidth, $kTB = -174 + 10\log(10^6) = -114$ dBm.

If the video bandwidth (that is, the postenvelope detector, low-pass filtering bandwidth) is significantly narrower than the IF bandwidth, then the variance in the measured average noise will be very small (approximately 1 dB). This mode is normally used only for calibrations in the RSMS.

However, if the video bandwidth is set to a value equal to or greater than the IF bandwidth (which is the case for RSMS spectrum survey measurements), then the maximum level sampled on thermal noise will be about 10-12 dB above the average, and the minimum level sampled on thermal noise will be about 10-20 dB below the average.

C.4.2 Interpretation of Signal Responses in Swept/m3/Sample Data

Because the sample detector value displayed for each bin is the value of the waveform at the end of each bin interval, the value displayed for a signal with a duty cycle of 100% will be equal to the peak power of the signal (if the signal was present for the entire bin interval). However, if a signal has less than a 100% duty cycle (and is not present during the entire bin interval), then the probability that the signal will be sampled is less than one. For example, if the signal is only present for half of the bin interval, there is only a 50% chance that the sample detector will capture the value of the signal (and a 50% chance that the measurement system's thermal noise will be displayed). For typical radar signals, which operate with a duty cycle of about 1:1000, the probability that a bin will display the radar signal value is only about 1/1000 (0.1%). The same rationale holds for impulsive noise; sample detection mode tends to display high-duty cycle signals, but not low-duty cycle signals such as radars and impulsive noise. This makes sample detection a desirable option for measurements in bands handling mobile communications, where the signals of interest have high duty cycles, and where measurement of impulsive noise is not desirable for the purposes of the RSMS project.

For Swept/m3/sample data, the highest curve shows the maximum signal ever captured by the sample detector on any trace at each measured frequency. This represents the highest value ever attained by high-duty cycle signals at each measured frequency; impulsive energy could have been present at even higher values, but would have been discriminated against by the sample detector. At frequencies where no signal was ever measured, the maximum curve will have a value of kTB + measurement system noise figure + (nearly) 10 dB. This value will be 10 dB higher than the average noise (middle) curve. Since a signal displayed on the maximum curve can occur with different amplitudes at different times, there is no way to determine, solely from examination of the maximum curve, how frequently the displayed signals were measured.

The middle curve of Swept/m3/sample data shows the power average (average of the measured decibel values) of all of the raw data traces gathered in the band. Qualitatively, the closer this curve comes to the maximum curve at any given frequency, the higher the percentage of scans in which the signal was observed. Quantitatively, it is not possible to derive an actual percentage of scans in which the signal was present. This is because the signal may not have always been received at the same level, and the level received on raw scans is not recorded. If, however, the average curve comes close to touching the maximum curve, then the signal must have been present in nearly 100% of the raw data traces. Conversely, if the maximum and mean curves are

far apart, then the signal was probably observed in a lower percentage of raw data scans. If no signals were ever measured at any given frequency, then the middle curve will show measurement system noise at a value of kTB + measurement system noise figure, about 10 dB below the maximum noise curve.

Finally, the lowest curve shows the minimum power level measured in any raw data trace, at each measured frequency bin. If no signal is measured in a bin during any sweep, then this curve will have a value of kTB + measurement system noise figure - (10-20 dB). This is 10-20 dB lower than the average curve. If a signal is present in 100% of the measurement sweeps, then a bump will occur in the minimum curve at that frequency. The amplitude of the bump will be equal to the minimum power measured for the signal. Thus, this curve serves the purpose of showing signals that are continuously present during the spectrum survey.

In this report, the nominal levels of the measurement system noise for the maximum, minimum and mean curves are indicated by tick marks on the lower left side of each swept/m3/sample graph. The tick marks, labelled “max sample noise,” “avg sample noise,” and “min sample noise,” are intended to assist report users in determining which graphed features are signal and which graphed features are measurement system noise.

C.5 Description of Swept/m3/+Peak Data Collection

If the Swept/m3 algorithm is performed using the positive peak (+peak) detector (see Section C.3 for a description of the +peak detector in the RSMS spectrum analyzers), then the data are called “Swept/m3/+peak.”

C.5.1 Interpretation of Noise Responses in Swept/m3/+Peak Data

The average noise level displayed by a measurement system using a +peak detector will be equal to kTB + measurement system noise figure + approximately 10-12 dB. With a 1-MHz IF bandwidth and a 10-dB measurement system noise figure, for example, the average +peak noise level would occur at $-174 \text{ dBm/Hz} + 10\log(10^6 \text{ Hz}) + 10\text{-dB noise figure} + 10\text{-dB peak detector offset} = -94 \text{ dBm}$.

If the video bandwidth (the postenvelope detector, low-pass filtering bandwidth) is equal to or greater than the IF bandwidth (which is the case for RSMS site survey measurements), and if the sweep time is short (a few tens of microseconds per bin), then the maximum level sampled on thermal noise will be about 10 dB above the average; the minimum level of thermal noise will be about 10 dB below the average. Note that this +/- 10-dB value for maximum and minimum levels of +peak noise is the same as the +/-10-dB offset levels for sample detection, but that the maximum, mean, and minimum peak-detected levels are 10 dB higher than the corresponding sample-detected levels.

Positive peak detection shows less than a +/-10-dB difference between the maximum, mean, and minimum as sample times increase (i.e., as sweep times become longer). This is because the

positive peak detector will have a higher probability of latching to a high noise level if it samples the noise for a relatively long interval. In this case, the minimum and average noise levels will approach the maximum noise level to within a few decibels. The maximum will be 2-3 dB higher than the short sweep-time values.

C.5.2 Interpretation of Signal Responses in Swept/m3/+Peak Data

Because the +peak detector latches to the highest value that the waveform assumes during each bin interval, the value displayed for a signal will be equal to the peak power of the signal (assuming that the measurement system is not bandwidth-limited in its response) regardless of the signal's duty cycle. This makes +peak detection mode useful for measuring impulsive activity such as radar signals. (This also means that +peak detection will also record impulsive noise in the spectrum.) Thus, the +peak detector is used in RSMS spectrum surveys to measure radiolocation bands and other bands where activity is dominated by impulsive (low-duty cycle) transmissions.

For Swept/m3/+peak data, the highest curve shows the maximum signal ever captured by the +peak detector on any trace in each measured frequency bin. At frequencies at which no signal was ever measured, the maximum curve will have a value of kTB + measurement system noise figure + about 10-dB peak detector offset + 10 dB. If the sweep time is short (a few tens of microseconds per bin), this will be about 10 dB higher than the average peak detector response. If the sweep time is much longer, the average will be higher, coming to within a few dB of the maximum. There is no way to determine, solely from examination of the maximum curve, how frequently the displayed signals were observed.

The middle curve of Swept/m3/+peak data shows the power average (average of the antilogs of the measured decibel values) of all the data traces that were gathered in the band. Qualitatively, the closer this curve comes to the maximum curve at any frequency, the higher the percentage of scans in which the signal was observed. Quantitatively, it is not possible to derive a percentage of time the signal was present, because the signal may not always be received at the same level. If, however, the average curve nearly touches the maximum curve, then the signal must have been present in nearly all of the raw data traces. Conversely, if the maximum and mean curves are far apart, then the signal was probably observed in a low percentage of scans. If no signals were measured at a frequency, and if sweep time is a few tens of milliseconds, the middle curve will show measurement system noise at a value of kTB + measurement system noise figure + about 10-dB peak detector offset. This value will be nearly 10 dB higher if the sweep time is appreciably longer.

Finally, the lowest curve shows the minimum power level measured with the +peak detector in any sweep, in each frequency bin. If no signal is measured at a frequency, and if the sweep time is a few tens of milliseconds, this curve will have a value of kTB + measurement system noise figure + about 10 dB peak detector offset - 10 dB, which is 10 dB lower than the mean peak detector curve. If the sweep time is longer, the minimum curve will approach the maximum and mean curves. If a signal is observed at a frequency in every data sweep, then a bump will occur

in the minimum curve at that frequency. Thus, this curve shows signals that are continuously present during the spectrum survey.

In this report, the nominal levels of the measurement system noise for the maximum, minimum and mean curves are indicated by tick marks on the lower left side of each swept/m3/+peak graph. The tick marks, labelled “max +peak noise,” “avg +peak noise,” and “min +peak noise,” are intended to assist report users in determining which graphed features are signal and which graphed features are measurement system noise.

C.6 Description of Swept/Max-Hold Data Collection

If a frequency-sweeping algorithm is performed using the +peak detector (see Section C.3 for a description of the +peak detector in the RSMS spectrum analyzers) while the spectrum analyzer display is being operated in the Maximum-Hold mode,³ then the data are referred to as “Swept/max-hold”

The measured data are peak-detected, maximum-hold scans. Each scan represents an interval of a few minutes of maximum-hold running on the measurement system. The scans do not contain mean or minimum information. They are intended only to show the presence of intermittent, low-duty cycle signals, and therefore no additional information is obtained,

The individual scans are cumed for the site survey report, and as a result, the final graphs show maximum, minimum, and mean curves. However, the distribution of maximum-hold data is narrow when noise is being measured, and so the difference between these curves is only about +,-3 dB on noise, instead of the +,-10 dB difference which usually characterizes swept/m3 data.

C.6.1 Interpretation of Noise Responses in Swept/Max-Hold Data

The maximum, mean, and minimum curves displayed by a measurement system will be nearly identical if the hold time is more than a few tens of microseconds per bin. If white noise is measured, the three curves will all have a value of about kTB (at room temperature) + measurement system noise figure + about 10-dB peak detector offset + 10 dB. With a 1-MHz IF bandwidth and a 10-dB measurement system noise figure, for example, the noise level is about $-174 \text{ dBm/Hz} + 10\log(10^6 \text{ Hz}) + 10\text{-dB noise figure} + 10\text{-dB peak detector offset} + 10 \text{ dB} = -84 \text{ dBm}$.

³In Maximum-Hold mode, the spectrum analyzer repeatedly sweeps a portion of spectrum, and saves the highest value measured in any sweep in each screen display bin. Thus, Maximum-Hold mode generates a maximum-level trace which is analogous to the maximum-level trace generated by RSMS software in the Swept/m3/+peak mode.

If the video bandwidth is equal to or greater than the IF bandwidth, then the maximum level sampled on thermal noise in maximum-hold mode is about 2 dB above the mean, and the minimum level sampled on thermal noise is about 2 dB below the mean.

C.6.2 Interpretation of Signal Responses in Swept/Max-Hold Data

Swept/max-hold measurement mode is ideal for capturing low-duty cycle signals from intermittently operating systems. It can be used in bands occupied by impulsive emitters that operate intermittently (e.g., airborne radars). A Swept/max-hold measurement displays the maximum activity observed in a band for an interval of a few minutes. No information is collected to indicate mean or minimum activity during that interval.

For cumed Swept/max-hold data, the highest curve shows the maximum signal ever captured by the +peak detector on any maximum-hold trace at each measured frequency. Since a signal displayed on the maximum curve could have occurred with different amplitudes at different times, there is no way to determine, solely from examination of the maximum curve, how frequently the displayed signals were actually observed.

The middle curve of cumed Swept/max-hold data shows the power-average (average of the antilogs of the measured decibel values) of all individual maximum-hold data traces that were measured in the band. Qualitatively, the closer this curve comes to the maximum curve at a frequency, the higher the percentage of scans in which the signal was observed. Quantitatively, it is not possible to derive an actual percentage of time that the signal was present, because the signal may not have always been received at the same level. If the mean curve nearly touches the maximum curve, then the signal must have been present in most of the raw data traces. If no signals were ever measured at any given frequency, then the middle curve will be about 3 dB lower than the maximum curve.

Finally, the lowest curve shows the minimum power level ever measured with the +peak detector in any maximum-hold data trace, at each measured frequency. If a signal was present in every scan, then the curve shows a bump at that frequency. Otherwise, the curve will show noise 3 dB below the mean curve. Thus, this curve serves the purpose of showing signals that were present in all of the scans.

C.7 Description of Stepped/+Peak Data Collection

Although most spectrum analyzers are routinely operated by sweeping in the frequency domain, this is not the most efficient method for the measurement of spectral emissions from pulsed emitters like radars. An alternative method, called stepping, is usually faster and can provide measurement results with wider dynamic range than is possible with sweeping.

Stepping is performed by tuning the measurement system to a frequency in the radar spectrum, and then performing a time-scan at that frequency over a span of zero hertz. Positive peak detection is always used. For rotating radars, the interval (called dwell time) for a single time-scan is set equal to or greater than the radar rotation time. (For electronically beam-scanning

radars, this interval is selected on the basis of the typical recurrence of the radar beam at the measurement site.) For example, if a radar has a 10-s rotation time, then the dwell time at each measured frequency might be set to 12 s. Thus, the emitter's rotating main beam would certainly be aimed in the direction of the measurement system at some moment during the 12-s time-scan. At the end of the dwell period, the highest-amplitude point that was measured is retrieved, connected for calibration factors, and stored. This process of waiting at a frequency in a 0-Hz span and recording the highest point measured during a radar rotation (or beam-scanning) interval is called a "step." When each step is completed, the measurement system is tuned to another, higher frequency, and the process is repeated.

The spectrum interval between adjacent measured frequencies is approximately equal to the IF bandwidth of the measurement system. For example, if a 1-MHz IF bandwidth is being used, then the frequency interval between steps will be about 1 MHz. The IF bandwidth is determined from the inverse of the emitter pulse width. For example, if 1 μ s is the shortest pulse width expected from emitters in a band, then a 1-MHz measurement (IF) bandwidth is used. In this manner, the entire spectrum is convolved with the measurement bandwidth across the band of interest.

Stepped measurements are used for all dominantly radiolocation (radar) bands. IF bandwidth and dwell times are optimized for typical radars in the band. The individual stepped measurement scans are cumed for spectrum surveys and the final graphs show a maximum, minimum, and mean value for each dwell time at each measured frequency during the entire survey.

C.7.1 Interpretation of Noise Responses in Stepped/+Peak Data

The mean noise level displayed by the measurement system in the +peak detector stepped mode will be equal to kTB (at room temperature) + measurement system noise figure + 10-dB peak detector offset. With a 1-MHz IF bandwidth and a 10-dB measurement system noise figure, for example, the mean +peak noise level is $-174 \text{ dBm/Hz} + 10\log(10^6 \text{ Hz}) + 10\text{-dB noise figure} + 10\text{-dB peak detector offset} = -94 \text{ dBm}$.

The difference between the maximum and minimum levels measured for noise in the stepped mode is small; the maximum and minimum curves will be about $\pm 2 \text{ dB}$ relative to the mean curve.

C.7.2 Interpretation of Signal Responses in Stepped/+Peak Data

Stepped/+peak measurement mode is ideal for capturing low-duty cycle signals from systems that direct energy at the measurement site at regular intervals (e.g., rotating radars). If the dwell time is greater than or equal to the rotation time of the radar, then the stepped algorithm will completely fill the emission envelope.

The maximum curve on each site survey graph for stepped measurements depicts the maximum envelope of the spectral emissions of the emitters observed in the band. The result is a

representation of the spectrum occupancy when emissions (usually radar beams) are directed at the measurement site.

The minimum curve represents the lowest signal ever measured at each frequency step during the survey. If an emitter is turned off during a single scan, then this curve will be at the system noise level for that emitter. At frequencies where this curve is above the noise level, but well below the maximum curve, the difference represents either varying emitter power output levels, varying emitter-scanning modes, varying propagation between the emitter and the measurement site, or a combination of these factors.

The mean curve represents the linear mean (the average of the antilogs of the decibel values of received signal level) for each frequency step in the band of interest during the site survey. This is not necessarily the same as the mean signal level transmitted by a radar to the measurement location. For example, a radar that was turned on during half the stepped scans, and turned off during the other half would appear, after cuming, with a maximum curve that is its emission envelope, a minimum curve that is the measurement system noise floor, and a mean curve roughly midway between the radar envelope and the noise. However, the radar would never have been measured at the amplitudes shown on the average curve.

C.8 Description of Swept/Az-scan Data Collection

In bands dominated by point-to-point fixed microwave communication systems, the main beams of the transmitters are seldom pointed towards the RSMS. To enhance the probability of intercepting signals from these sources, a dish antenna is used. However, the site survey data must include signals received from all points on the horizon. These two apparently contradictory requirements are reconciled by performing azimuth scanning with the dish antenna. The RSMS dish antenna is pointed at the horizon and slowly rotated through 360°. Simultaneously, a spectrum analyzer sweeps the band of interest with positive peak detection and maximum-hold scan mode. Such measurements are called “Swept/az-scan.”

The dish antenna is rotated at approximately 6°/s (1 rpm), while the sweep time across the band is set at 20 ms. At the highest frequencies, where the dish beamwidth is about 1°, the dish rotates through one beamwidth in 1/6 s (170 ms). This is long enough for 7 or 8 sweeps (170 ms/20 ms) within the beam width. Thus, every point on the horizon is sampled at least 7 or 8 times across the entire band of interest. Maximum-hold mode and positive peak detection ensure that any signal that arrives at the RSMS site is retained on the scan.

The dish is rotated twice around the horizon: once with horizontal polarization and once with vertical polarization. The purpose is to observe signals from point-to-point links utilizing either polarization. The two polarization scans are combined to show the maximum envelope of both scans on a single data curve.

The single data curve is corrected for noise diode calibration factors and recorded. Unlike other RSMS site survey measurements, this measurement is only performed once at each survey

location and no cuming is performed on this data. Activity in these bands does not vary much with time and little information is gained by measuring these bands repetitively.

C.8.1 Interpretation of Signal Responses in Swept/Az-scan Data

Swept/az-scan data show the presence of a signal at some point or points on the horizon. The data curve does not reveal the direction of any signals, but does show the aggregate occupancy of the spectrum by all point-to-point signals detected omnidirectionally on the horizon.

Generally, two types of signals will be noted in the az-scan graphs: those having narrow emission spectra, and those having wider emissions. The narrow signals are analog links, and the wider signals are digital links. Because a single transmitting tower (a single point on the horizon) may have many channels in operation (often located next to each other in the spectrum), clusters of signals with uniform amplitudes will be observed. Space-to-earth and earth-to-space links in these bands are not normally detected by the RSMS.

APPENDIX D: CALIBRATION OF THE MEASUREMENT SYSTEM

D.1 Introduction

Measurement system calibration is performed prior to and during every RSMS site survey. Calibration curves, as in Figure D-1, showing system noise figure and gain corrections as a function of frequency across the entire frequency range are generated. As measurements are performed, gain corrections are automatically added to every raw data point that is collected. Gain and noise figure curves are used by RSMS operators to determine the relative health of the measurement system, and are also used to pinpoint locations in the measurement system RF path that are operating suboptimally.

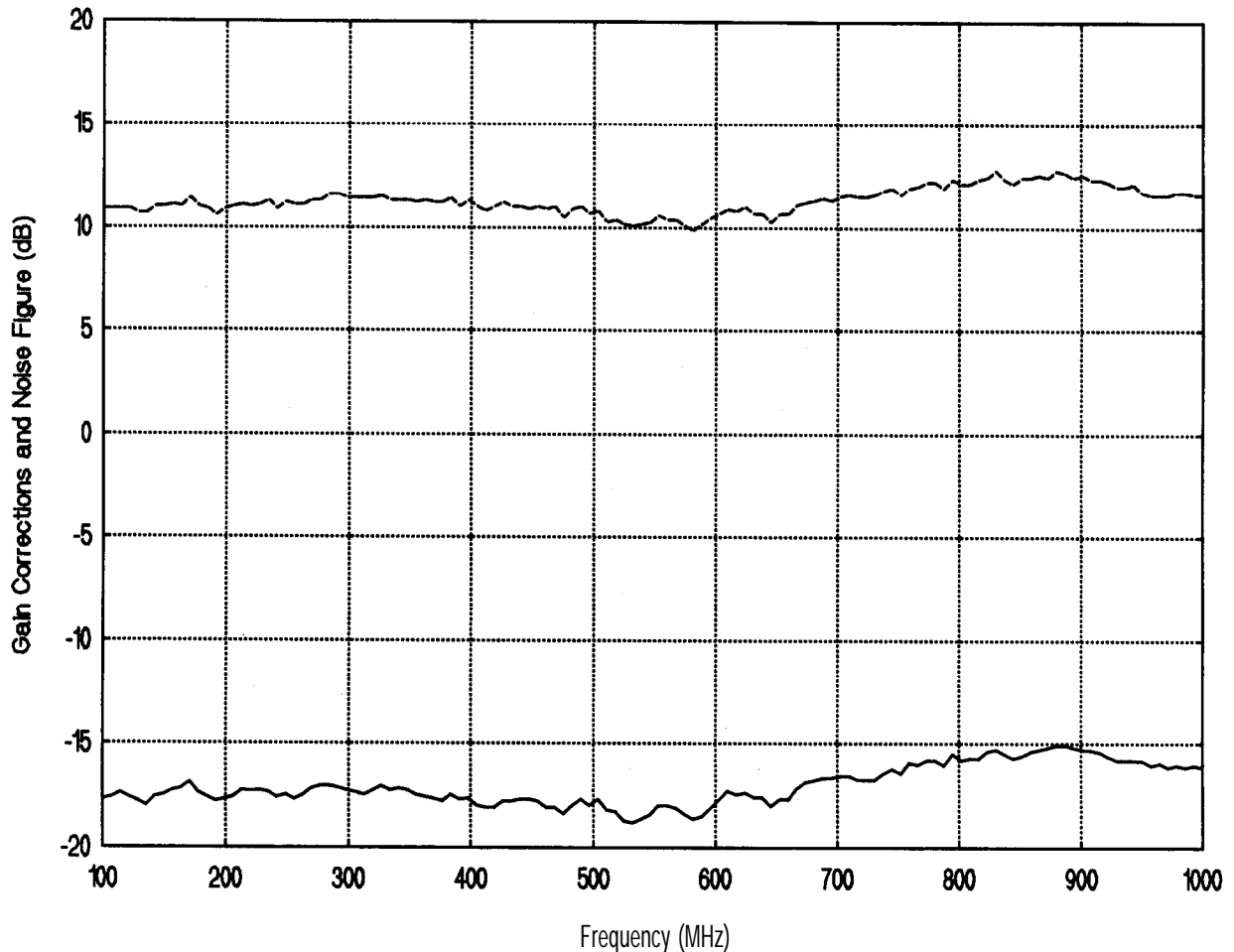

Figure D-1. Example calibration graph for RSMS System-1 showing noise figure (upper; dashed curve) and correction factors (lower; solid curve).

RSMS calibrations are performed exclusively with noise diodes such as the one shown in Figure D-2. Although the technique of noise diode calibration is not as well known in electrical engineering activities as other techniques (e.g., signal generators or vector network analyzers),

noise diodes are commonly used for calibration of measurement systems where minimal size, weight, and power consumption are required. Noise diodes provide these features while maintaining high calibration accuracy and this is why they are used for RSMS calibrations.’ This appendix describes the theory and operation of RSMS noise diode calibrations.



Figure D-2. A typical noise diode solid state noise source. A +28-volt potential applied to the BNC connector on the right produces +24-dB excess noise ratio from the type N connector on the left.

‘Another example of noise diode use for measurement system calibration is the Cosmic Background Explorer (COBE) satellite, which recently produced a whole-sky map of 2.5-K background radiation, The same features that make noise diodes attractive for critical satellite calibrations also make them attractive for RSMS work at field locations.

D.2 Theory

RSMS calibrations are implemented as a variant of the y-factor calibration method [1]. The y-factor method of amplitude calibration provides for a simple, yet accurate characterization of the amplitude response and noise figure of an RF receiver system. Using noise diodes, amplitude uncertainties of 1 dB in calibration may be achieved in field calibrations over a frequency range of more than 18 GHz.

The noise diode calibration of a receiver tuned to a particular frequency may be represented in simple, lumped-component terms as in Figure D-3. In this diagram, the symbol labelled Σ represents a power-summing function that linearly adds any power at the measurement system input to the inherent noise power of the system. The symbol labelled g represents the total gain in the measurement system. The measurement system noise factor is denoted by nf_s , and the input is a noise diode with an excess noise ratio of enr_d .²

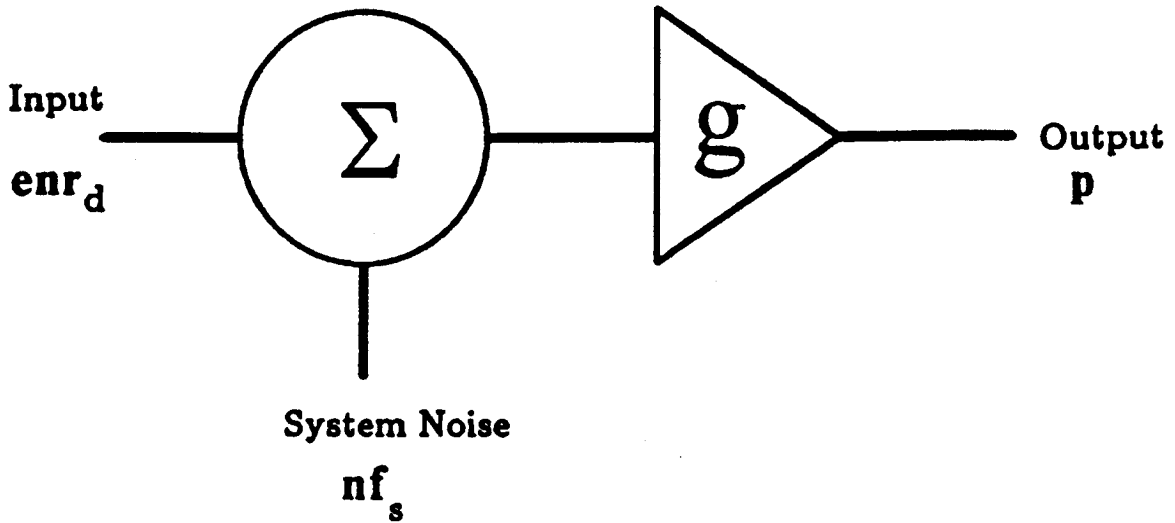

Figure D-3. Lumped-component noise diode calibration schematic diagram; reference equations (D1) and (D2).

Note that in this appendix all algebraic quantities denoted by lower-case letters, such as “g,” represent linear units. All algebraic quantities denoted by upper-case letters, such as “G,” represent decibel units. Lower-case and upper-case quantities are connected to each other by the

²Many references do not offer a clear explanation of the difference between noise factor and excess noise ratio. Noise factor is the ratio of noise power from a device and thermal noise, (n_{device}/kTB). The excess noise ratio is equal to the noise factor minus one, making it the fraction of power above (in excess of) kTB . The noise figure of a system is defined as $10 \log$ of the noise factor, forcing a solution for noise factor in the calculations. However, since many noise sources are specified in terms of excess noise ratio, that quantity must sometimes be used.

relation (UPPER CASE TERM) = 10log(lower case term); for example, $G = 10\log(g)$, or if $\text{enr}_d = 100 \text{ mW}$, then $\text{ENR}_d = 20 \text{ dBm}$,

In noise diode calibration, the primary concern is the difference in output signal when the noise diode is switched on and off. For the (noise diode = on) condition, the linear expression is:

$$p_{\text{on}} = (nf_s + \text{enr}_d) \times gkTB, \quad (\text{D1})$$

and for the noise diode = off condition:

$$P_{\text{off}} = (nf_s) \times gkTB. \quad (\text{D2})$$

The quantity k is Boltzmann's constant, equal to $1.38 \times 10^{-20} \text{ mW*s/K}$ (milliwatt seconds per kelvin). T is the system temperature in kelvin, and B is the bandwidth in hertz. The ratio of these two quantities is called the Y factor:

$$y = (p_{\text{on}}/p_{\text{off}}) = (nf_s + \text{enr}_d)/(nf_s) \quad (\text{D3a})$$

$$Y = 10\log(y) = 10\log(p_{\text{on}}/p_{\text{off}}) = P_{\text{on}} - P_{\text{off}}. \quad (\text{D3b})$$

From equation (D3), we solve for the system noise factor:

$$nf_s = (\text{enr}_d)/(y-1). \quad (\text{D4})$$

The measurement system noise figure is 10 log of the noise factor:

$$\begin{aligned} \text{NF}_s &= 10\log(\text{enr}_d/(y-1)) \\ &= \text{ENR}_d - 10\log(y-1) \\ &= \text{ENR}_d - 10\log(10^{Y/10} - 1). \end{aligned} \quad (\text{D5})$$

Solving equations (D1) and (D2) for gain, g , yields:

$$g = (p_{\text{on}} - p_{\text{off}})/(\text{enr}_d \times kTB) \quad (\text{D6a})$$

$$\begin{aligned} G &= 10\log(p_{\text{on}} - p_{\text{off}}) - 10\log(\text{enr}_d \times kTB) \\ &= 10\log(10^{P_{\text{on}}/10} - 10^{P_{\text{off}}/10}) - \text{ENR}_d - 10\log(kTB). \end{aligned} \quad (\text{D6c})$$

In RSMS calibrations, equation (D6c) is used to calculate gain from measured noise diode values. Note that this calculation utilizes the difference between p_{on} and p_{off} , rather than the y -factor ratio of these values. Thus, the RSMS noise diode calibration is a variant of the standard y -factor calibration technique.

Although equation (D5) could be used to calculate measurement system noise figure, the implementation in RSMS software uses an equivalent equation. It is derived from (D1):

$$nf_s = p_{off}/gkTB \quad (D7a)$$

$$NF_s = 10\log(p_{off}) - 10\log(gkTB) \quad (D7b)$$

$$= P_{off} - G - 10\log(kTB).$$

Substituting expression (D6b) for gain into (D7b) yields:

$$NF_s = P_{off} + ENR_d - (10^{P_{on}/10} - 10^{P_{off}/10}). \quad (D7c)$$

In RSMS calibrations, equation (D7c) is used to calculate noise figure. Whenever an RSMS calibration is performed, P_{on} and P_{off} are measured at 100 frequencies across the frequency range to be measured, and equations (D6c) and (D7c) are then used to calculate system gain and noise figure for each of those 100 calibration points. The result is the gain response and noise figure of the system as a function of frequency for the frequency range of the measurement. Negative values of the system gain are stored in look-up tables, and are added to raw data values as a correction factor. The gain-corrected power values are stored as spectrum survey data.

Antenna gain corrections are not routinely added to the raw data points as part of RSMS spectrum survey measurements; if incident field strength is required, then antenna correction factors are subtracted separately, after the measurement has been completed. The conversion from power measured in the 50-ohm RSMS circuitry to incident field strength in free space is:

$$FS_{free\ space} = (P_{meas}) + (77.2\ dB) + (20\log(f)) - G_{iso} \quad (D8)$$

where

$$FS_{free\ space} = \text{incident field strength, dBuV/m;}$$

$$P_{meas} = \text{power measured in 50 ohms, dBm, corrected for RSMS path gain calibration;}$$

$$f = \text{measurement frequency, MHz;}$$

$$G_{iso} = \text{gain of the measurement antenna, dBi (dB relative to isotropic antenna).}$$

Alternatively, if the receiving antenna correction factor (ACF) is known, instead of the antenna gain relative to isotropic, then the incident field strength conversion equation is:

$$FS_{free\ space} = (P_{meas}) + (107\ dB) + ACF \quad (D9)$$

where

$$ACF = \text{antenna correction factor, dB.}$$

D.3 Application

Excluding the receiving antenna, the entire signal path within the RSMS is calibrated with a noise diode source both before and during a spectrum survey; a noise diode, such as shown in Figure D-2, is connected at the point where the RF line attaches to the receiving antenna. The connection may be accomplished manually or via an automatic relay, depending upon the measurement scenario. The noise level in the system is measured at 100 points across the desired frequency range with the noise diode turned on (ON) and turned off (OFF). The RSMS control computer stores all of the ON vs. OFF noise diode values. The control computer then uses the measured difference between ON and OFF at each of the 100 calibration points to solve the calibration equations (D6c) and (D7c) shown above. The gain values are inverted in sign to become correction values. The resulting set of 100 noise figure and gain correction values are stored as a function of system frequency in look-up tables on the computer disk. The frequency-dependent gain-correction curve is used to automatically correct the measured amplitudes of all received signals in subsequent measurements. Figure D-1 shows the gain-correction curve and noise figure curve for a typical RSMS measurement.

This calibration technique has proven very successful for field-deployed radio spectrum measurement systems. It is a fast way to determine sensitivity and gain-correction values for a measurement system, and it is also very useful for isolating the gains and losses through individual components of the measurement system, such as RF lines and amplifiers. Compared to alternative calibration equipment, such as signal generators or vector network analyzers, noise diodes have several advantages:

- ▶ The physical size and weight of a noise diode are comparatively small: dimensions are typically less than 5" long and less than an inch diameter; weight is a few ounces.
- ▶ Power consumption is low, at about 50 mA of direct current at a +28 volt potential.
- ▶ Cost is low, at a few hundred dollars or less for a noise diode.
- ▶ Because noise diode sources are inherently broadband (typically 100 MHz to 18 GHz or more), there are no frequency-tracking problems in the calibration, as are encountered with many other calibration techniques.

All of these features lend themselves to measurements in the field, where small size and weight, low power consumption, and simplicity of operation are all at a premium. Moreover the low cost and small requirements for size, weight, and power make it possible to locate several noise diodes at various places in the measurement system, and to carry spares in the event that a noise diode fails. Noise diodes can themselves be calibrated by such entities as the National Institute of Standards and Technology.

At frequencies below 12 GHz, accuracy of noise diode calibration with spectrum analyzers installed in the RSMS is good to within a decibel. At frequencies from 12-18 GHz, accuracy falls to about ± 2.5 dB due to a higher system noise figure. For noise diodes producing an ENR of about +25 dB, as are used for RSMS measurements, calibrations cannot be performed in a practical sense if system noise figure is more than about 30 dB or is less than about 1 dB. This is because the difference between P_{on} and P_{off} becomes too small to measure reliably in the first case, and too close to the rated ENR of the noise diode to measure reliably in the second case. Noise diode calibrations will not provide information on phase shift as a function of frequency; if a measurement system must be calibrated for phase shift, then additional or alternative calibration methods must be used.

D.4 Reference

- [1] S. Adam, *Microwave Theory and Applications*, Englewood Cliffs, NJ: Prentice-Hall, Inc., 1969, pp. 490-502.

BIBLIOGRAPHIC DATA SHEET

1. PUBLICATION NO. 97-334		2. Gov't Accession No.	3. Recipient's Accession No.
4. TITLE AND SUBTITLE Broadband Spectrum Survey at San Diego, California		5. Publication Date December 1996	
		6. Performing Organization Code	
7. AUTHOR(S) Frank H. Sanders, Bradley J. Ramsey, Vincent S. Lawrence		9. Project/Task/Work Unit No.	
8. PERFORMING ORGANIZATION NAME AND ADDRESS Institute for Telecommunication Sciences, ITS.S2 U.S. Department of Commerce 325 Broadway Boulder, CO 80303-3328		10. Contract/Grant No. 910-6152 NTIA/ITS	
11. Sponsoring Organization Name and Address NTIA HCHB, 14th & Constitution Ave., NW Washington, DC 20230		12. Type of Report and Period Covered	
		13.	
14. SUPPLEMENTARY NOTES			
15. ABSTRACT (A 200-word or less factual summary of most significant information. If document includes a significant bibliography or literature survey, mention it here.) NTIA is responsible for managing the Federal Government's use of the radio spectrum. In discharging this responsibility, NTIA uses the Radio Spectrum Measurement System to collect data for spectrum utilization assessments. This report details such a data collection effort spanning all of the spectrum from 108 MHz to 19.7 GHz in the metropolitan area of San Diego, California, during February and March of 1995.			
16. Key Words (Alphabetical order, separated by semicolons) land mobile radio (LMR); radar emission spectrum; radio frequency environment; Radio Spectrum Measurement System (RSMS); spectrum resource assessment; spectrum survey			
17. AVAILABILITY STATEMENT <input checked="" type="checkbox"/> UNLIMITED. <input type="checkbox"/> FOR OFFICIAL DISTRIBUTION.		18. Security Class. (This report) Unclassified	20. Number of pages 116
		19. Security Class. (This page)	21. Price: